

**KLS martin**  
GROUP



Neurochirurgie  
Neurosurgery  
Neurocirugía  
Neurochirurgie  
Neurochirurgia

**Neuro**



# Chirurgische Instrumente



Seit 1923







Surgical Innovation is our Passion



# Chirurgische Innovation ist unsere Leidenschaft

Wie kommt man dazu, über 12.000 chirurgische Instrumente zu entwickeln, zu fertigen und zu vermarkten? Produkte, die sich durch klare Alleinstellungsmerkmale auszeichnen. Es ist die Leidenschaft, neue Wege zu finden, die Menschen helfen und der Gesundheit dienen.



## **Surgical Innovation is our passion**

What is the secret behind the development, manufacture and distribution of over 12,000 exclusive surgical instruments, products whose distinguishing characteristics truly set them apart from all the others? The answer is passion, the overwhelming desire to discover new ways of serving humankind in its search for ultimate health.



## **La innovación quirúrgica es nuestra pasión**

¿Cómo es posible concebir, producir y comercializar más de 12.000 instrumentos quirúrgicos? Estamos hablando de productos que se caracterizan por unas propiedades exclusivas, claramente definidas. La clave está en que nos motiva la pasión por encontrar nuevos caminos para ayudar a las personas y fomentar la salud.



## **Notre passion est l'innovation chirurgicale**

Comment est-il possible de développer, fabriquer et commercialiser plus de 12.000 instruments chirurgicaux ? Des produits dont les caractéristiques distinctives sont leur position unique sur le marché. Et bien, ceci est en fait dû à la passion de vouloir trouver de nouvelles méthodes afin de venir en aide aux personnes et de servir la santé.



## **L'innovazione nella chirurgia è la nostra passione**

Che cosa ci spinge a progettare, produrre e distribuire più di 12.000 strumenti chirurgici dalle caratteristiche uniche? Sono la nostra passione e il desiderio di aiutare il prossimo e cercare nuove vie per migliorare la salute.





Am Anfang stand die Vision, aus kleinen Firmen eine international agierende Unternehmensgruppe zu bilden. Das war 1923. Heute beschäftigt die KLS Martin Group über 1.300 Mitarbeiter und ist einer der weltweit führenden Konzerne für Entwicklung, Produktion und Vertrieb medizintechnischer Produkte, die in enger Zusammenarbeit mit denjenigen entwickelt werden, die sie letztlich einsetzen: den Chirurgen.

EN

#### **In the beginning there was a vision**

Our vision, in 1923, was to create an internationally operating group of companies from a handful of smaller businesses. Today, the KLS Martin Group has a staff of over 1,300 and is one of the leading globally acting enterprises for the development, manufacture and distribution of medical devices. We work hand in hand with those holding the scalpel: the surgeons.

ES

#### **Todo comienzo parte de una visión**

Al principio la visión consistía en conformar, a partir de pequeñas empresas, un grupo empresarial con intervención a escala mundial. Corría el año 1923 en aquel entonces. Hoy en día, el KLS Martin Group da trabajo a más de 1.300 personas y se encuentra a nivel mundial entre los consorcios líderes dedicados al desarrollo, producción y comercialización de productos medicotécnicos, diseñados en estrecha colaboración con aquel grupo de personas que finalmente los emplean: los cirujanos.

FR

#### **Tout commença par une vision**

Au début, en l'an 1923, naquit la vision de pouvoir former un groupe d'entreprises à activités internationales à partir de petites entreprises. Le groupe KLS Martin Group occupe actuellement plus de 1.300 employés et il est l'un des groupes leaders sur le marché mondial dans le secteur du développement, de la production et de la commercialisation de produits médico-techniques, ces produits ayant été développés en étroite collaboration avec ceux les utilisant, c'est-à-dire les chirurgiens.

IT

#### **All'inizio c'era una visione**

All'inizio c'era una visione: fondere piccole ditte per creare un gruppo aziendale operante a livello internazionale. Era il 1923. Oggi il KLS Martin Group ha più di 1.300 dipendenti ed è una delle imprese leader al mondo nella progettazione, produzione e distribuzione di prodotti medicali creati in stretta collaborazione con gli utenti finali: i chirurghi.

Am Anfang  
stand eine Vision





## Qualitätssicherung ohne Kompromisse

Unsere Produkte erfüllen den Anspruch anwendungsbezogener Funktionalität, intelligenter Handhabung und hoher Qualität. Und wenn es um die Erfüllung dieses Anspruchs geht, machen wir keine Kompromisse. Um dies zu gewährleisten, unterhält KLS Martin ein eigenes hochmodernes Labor sowie ein Technikum, in denen die Qualität unserer Erzeugnisse – auch unter extremen Bedingungen – auf „Herz und Nieren“ getestet und dokumentiert werden.

EN

### Quality assurance uncompromising

Our products are designed to consistently meet high demands for application-oriented functionality, intelligent operation and top quality. And we are not prepared to compromise when it comes to meeting the justified expectations of our customers, present and future – your standards become ours. KLS Martin runs their own ultramodern laboratories and a pilot plant, where our products are stress-tested under extreme conditions – every step is documented before release.

ES

### Un seguro de calidad sin compromisos

Nuestros productos cumplen el requisito de estar dotados de la funcionalidad conforme a su aplicación, su manipulación es inteligente y son de alta calidad. No transigimos a la hora de cumplir con estas condiciones esenciales. Por este motivo, KLS Martin mantiene un laboratorio propio, altamente moderno, así como una escuela técnica, donde se ensaya y documenta la calidad de nuestros productos – inclusive bajo condiciones extremas –, examinándolos “hasta la médula”.

FR

### Une assurance qualité sans compromis

Nos produits répondent aux exigences requises par une fonctionnalité relative à l'application, un maniement intelligent et une qualité élevée. Et nous n'acceptons aucun compromis lorsqu'il s'agit de répondre à ces exigences. KLS Martin possède à ce but son propre laboratoire ultramoderne et son centre technique dans lesquels la qualité de nos produits fabriqués est testée minutieusement – même sous des extrêmes conditions – et les résultats des tests sont documentés.

IT

### Assicurazione della qualità senza compromessi

I nostri prodotti sono stati progettati guardando alle esigenze della prassi applicativa, offrono una manipolazione intelligente e sono di qualità elevata. A tale riguardo non facciamo compromessi. Per garantire questo standard, KLS Martin ha un laboratorio altamente moderno e un centro tecnologico in cui controlla e documenta la qualità di tutti i prodotti, anche in condizioni estreme.

## Wir setzen Standards für die Instrumentenaufbereitung

Wie lassen sich Medizinprodukte vor mechanischer, thermischer oder chemischer Belastung schützen? Was muss man bei der Aufbereitung und Pflege besonders feingliedriger Mikrochirurgie-Instrumente berücksichtigen? Als Mitglied wichtiger Gremien und Arbeitskreise – wie z. B. dem Arbeitskreis Instrumenten-Aufbereitung AKI – gibt KLS Martin Antworten und erarbeitet Lösungen für die optimale Aufbereitung und Pflege von Instrumenten. Von der Auswahl angemessener Reinigungsverfahren bis hin zu Sterilisationsverfahren.

EN

### Standards and best practice: instrument preparation

How best to protect surgical instruments from mechanical, thermal and chemical stresses? What steps are performed to ensure optimal preparation and care of highly delicate microsurgical instruments? KLS Martin, in their capacity as member of important advisory boards and working groups – for example, Working Group Instrument Preparation AKI – is in a position to provide answers and solutions to all inquiries with regard to the optimal preparation and care of instruments, ranging from knowledgeable advice on appropriate cleaning methods through sterilization processes.

ES

### Los estándares y la mejor práctica para la preparación de instrumentos

¿Cómo se pueden proteger los productos médicos contra la actuación de factores mecánicos, térmicos y químicos? ¿Qué es lo que hay que considerar en el momento de preparación y cuidado del instrumental microquirúrgico, constituido fundamentalmente por componentes finos? En función de miembro de asociaciones y comités laborales importantes – como por ejemplo, el Comité Alemán de Trabajo de Preparación de Instrumental AKI – KLS Martin ofrece respuestas y elabora soluciones para el tratamiento y cuidado óptimos del instrumental. Éstas abarcan desde la selección de métodos de limpieza adecuados hasta el procedimiento de esterilización.

FR

### Normes et pratiques idéales pour la préparation des instruments

Comment protéger les produits médicaux contre d'éventuelles contraintes mécaniques, thermiques ou chimiques? Quels points doivent être pris en considération pour le traitement et l'entretien d'instruments micro-chirurgicaux à fine ossature? A titre de membre d'importants organismes et cercles de travail, tels que par exemple l'AKI (Arbeitskreis Instrumenten-Aufbereitung = cercle de travail pour le traitement des instruments), KLS Martin donne des réponses et élabore des solutions pour assurer un traitement et un entretien optimaux des instruments. Depuis la sélection de procédés de nettoyage adéquats jusqu'au procédé de stérilisation.

IT

### Standard e “best practice” per la preparazione degli strumenti

Come si possono proteggere gli strumenti medici da agenti aggressivi di tipo meccanico, termico o chimico? Cosa occorre tenere presente nella preparazione e nella manutenzione di strumenti microchirurgici particolarmente delicati? Quale membro di importanti organi e gruppi di lavoro, come ad esempio AKI, il gruppo tedesco di lavoro per la corretta preparazione degli strumenti, KLS Martin dà risposta e sviluppa soluzioni per la preparazione e la manutenzione ottimali degli strumenti, dalla scelta dei sistemi di pulizia più idonei alle procedure di sterilizzazione.



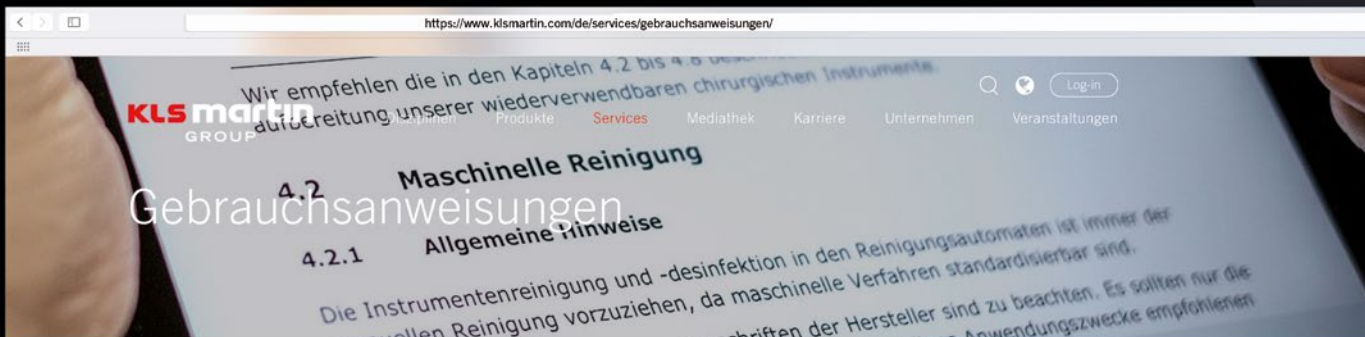

Wir bieten Ihnen die Möglichkeit, zu Ihrem KLS-Martin-Produkt die passende Gebrauchsanweisung digital anzufordern.

Gebrauchsanweisung anfordern

Anrede

Titel



Lebenslange Garantie  
für MARTIN-Instrumente

... aus Linea

## Lebenslange Garantie – wann immer Sie sie brauchen

Keine Frage, wir sind stets auf der Suche nach der noch besseren Lösung. Das zeichnet den kontinuierlichen Fortschritt in unserem Produktportfolio aus. Gleichwohl sind alle unsere Instrumente qualitativ erstklassig und werden höchsten Ansprüchen gerecht. Und weil wir davon überzeugt sind, gewähren wir auf jedes Instrument bei sach- und fachgerechtem Einsatz eine lebenslange Garantie.

EN

### **Whenever you need it – our lifetime guarantee**

Our determined and ongoing search for the perfect solution is reflected in the dynamic nature of our product portfolio. You simply will not find better instruments on the market. And because we truly believe in the outstanding quality of our products, we offer a lifelong guarantee on each instrument, in connection with appropriate and professional use.

ES

### **Necesite lo que necesite – la garantía es de por vida**

Lo cierto es que siempre estamos en la búsqueda de una solución que sea aún mejor. Esto es lo que determina el progreso continuado de nuestra cartera de producción. Todos nuestros instrumentos son de la misma calidad máxima cumpliendo, por lo tanto cumplan con los requisitos más exigentes. Y como estamos convencidos de ello, garantizamos en todo nuestro instrumental una garantía de por vida, siempre y cuando se utilice como es debido y según las normativas.

FR

### **Si jamais vous en avez besoin – notre garantie à vie**

Nous sommes, sans aucun doute, toujours à la recherche de la solution optimale. Ce fait caractérise le progrès continu dans notre porte-feuille de produits. Tous nos instruments sont à la fois de toute première qualité et conformes à des exigences maximales. Et étant donné ce fait, nous garantissons sur chaque instrument une garantie à vie, à condition que les instruments soient utilisés de manière adéquate et compétente.

IT

### **Ogni qual volta ne avete bisogno – la nostra garanzia a vita**

Essendo alla ricerca di soluzioni sempre migliori, i nostri prodotti vengono costantemente migliorati. Essi sono di qualità eccellente e soddisfano persino le esigenze più elevate. Per questo possiamo accordare una garanzia a vita per ogni strumento impiegato in modo appropriato e corretto.

## Instrumente schneller finden – die Katalog-Handhabung

Es ist ganz einfach: Die Artikelnummer gibt Auskunft über Produkt, Produktgruppe und Größe/Figur des Instruments. Jedes Produkt wird in Größe und Funktion vollständig beschrieben sowie maßstabsgetreu abgebildet – die Arbeitsenden je im Verhältnis 1 : 1. So finden Sie schneller, was Sie wirklich brauchen.

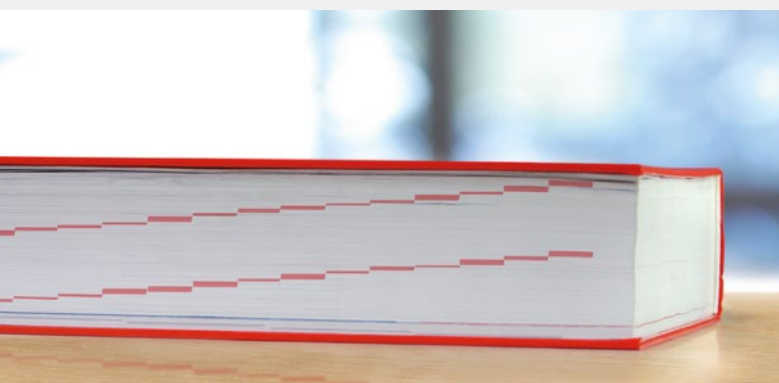

EN

### Finding the instruments you need – how to use the catalogue

Straightforward and easy: The article number informs you about the product, product group and instrument size. Size and function of each product are described in full detail and illustrated to scale – the working ends in a ratio of 1 : 1. You can quickly find exactly what you are looking for.

ES

### Encuentre el instrumental que necesita – modo de consultar el catálogo

Es muy simple: El número de artículo facilita una información acerca del producto, el grupo de producto y el tamaño del instrumental. Encontrará la descripción completa de tamaño y función de cada producto y una ilustración a escala; los extremos funcionales aparecerán en relación 1 : 1. Así Ud. podrá encontrar más rápidamente lo que realmente necesita.

FR

### Comment trouver les instruments requis – l'utilisation du catalogue

C'est tout simple : Le numéro d'article fournit des informations sur le produit, le groupe de produits et la taille de l'instrument. Une description détaillée de la taille et du fonctionnement de chaque produit est fournie et tous les produits sont illustrés à l'échelle – les extrémités des instruments étant illustrées au rapport 1 : 1. Ainsi vous trouvez plus rapidement ce dont vous avez vraiment besoin.

IT

### Trovare gli strumenti che cercate – i cataloghi

È semplicissimo: Il codice articolo fornisce informazioni sul prodotto, sulla categoria e sulla grandezza dello strumento. Il catalogo presenta una descrizione dettagliata di ciascun prodotto, delle sue dimensioni e funzioni nonché un'illustrazione in scala degli strumenti, le cui estremità sono riprodotte in rapporto 1 : 1. In questo modo trovate più velocemente ciò di cui avete veramente bisogno.

Abbildungsmaßstab  
Illustration scale  
Los productos en escala  
Produits à l'échelle  
Prodotti dimensioni

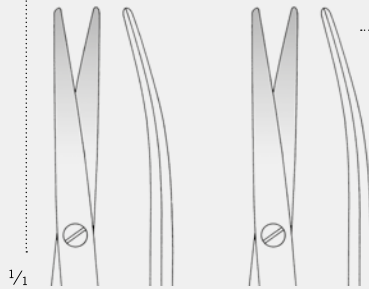

Arbeitsenden  
Working end  
El extremo funcional  
del producto  
Extrémité opératoire  
du produit  
L'estremità funzio-  
nale del prodotto

Autor (wenn vorhanden)  
Author (if available)  
Autor (si lo hay)  
Auteur (s'il existe)  
Autore (se disponibile)

11-339-12-07  
12,5 cm / 5"  
feines Modell  
fine pattern  
modelo fino  
modèle fin  
modello delicato

11-339-18-07  
18 cm / 7"  
feines Modell  
fine pattern  
modelo fino  
modèle fin  
modello delicato

Salyer  
11-339-12-07 –  
11-339-18-07

Angaben zum Produkt  
Product information  
Datos sobre el producto  
Données sur le produit  
Indicazioni relative al  
prodotto

für Lippen-, Kiefer-, Gaumenspalte  
for Cleft Palate  
para fisura paladar  
pour fente du palais  
per cheilo-labbro-palatoschisi

Maße  
Dimensions  
Dimensiones  
Dimensions  
Dimensioni

	Materialart	Material type	Tipo de material	Type de matériau	Tipo di materiale
01	Stahl 18/8 martinit, antimagnetisch, rostfrei, säurebeständig	steel 18/8 martinit, antimagnetic, stainless, acid-resistant	acero 18/8 martinit, antimagnético, inoxidable, resistente a los ácidos	acier 18/8 martinit, antimagnétique, inoxydable, résistant aux acides	acciaio 18/8 martinit, antimagnetico, inossidabile, resistente agli acidi
02	verchromt	chrome-plated	cromado	chromé	cromato
04	alle übrigen, nicht besonders gekennzeichneten Materialarten	all other, not specially marked material types	todos los otros tipos de materiales no identificados de forma especial	tous les autres types de matériau sans marquage spécial	tutti gli altri tipi di materiali senza marcatura speciale
07	rostfreier Stahl	stainless steel	acero inoxidable	acier inoxydable	acciaio inossidabile
08	Silber	silver	plata	argent	argento
09	Titan	titanium	titanio	titane	titanio
14	Solid Black	Solid Black	Solid Black	Solid Black	Solid Black
98	Ersatzteil	replacement part	pieza de repuesto	pièce de rechange	pezzo di ricambio



# Erläuterungen zum Katalog

Catalog explanations

Explicaciones complementarias al catálogo

Explicacions sur le catalogue

Spiegazioni relative al catalogo



Verweis · Reference · Referencia  
Référence · Rimando



Für Fig. Nr. · for fig. No.  
para fig. No. · pour fig. No.  
per fig. N.



Schneidenlänge · cutting edge length  
longitud de hojas cortantes  
longueur de lames · lunghezza di lame



Schnittlänge · cutting length  
longitud de corte · longueur de coupe  
lunghezza di taglio



Anzahl Zähne · number of teeth  
cantidad de dientes · quantité de dents  
quantità di denti



Anzahl Zinken · number of teeth  
cantidad de dientes · quantité de dents  
quantità di denti



Spreizweite · spreading width  
extensión · écartement  
apertura



Fadenstärke · thread size  
grosor de hilos · grosseur de fils  
spessore di fili



De Bakey  
Zahnung · serration · dentado  
denture · dentatura



Cooley  
Zahnung · serration · dentado  
denture · dentatura



Cooley  
Zahnung · serration · dentado  
denture · dentatura



Schließkraft · closing pressure ·  
fuerza de oclusión · pression de fermeture  
pressione di chiusura



Schaftlänge · shaft length  
longitud del vástago · longueur du tige  
lunghezza del gambo



Edelstahl · stainless steel  
acero inoxidable · acier inoxydable  
acciaio inossidabile



Titan · titanium · titanio  
titane · titanio



Aluminium · aluminum · aluminio  
aluminium · alluminio



Silikon · Silicone  
Silicona · Silicone · Silicene



Kaltlicht · cold light · luz fría  
lumière froide · luce fredda



Solid Black  
Hartstoffbeschichtung  
(für eine längere Standzeit)  
Hard-coated surface  
(for extended life)  
Recubrimiento con material duro  
(para una vida útil más larga)  
Revêtement à surface dure  
(pour une durée de vie prolongée)  
Rivestimento in materiale rigido  
(per una più lunga durata)

## TC GOLD

Instrumente mit Hartmetalleinlagen  
Instruments with tungsten carbide inserts  
Instrumentos con filos de carburo de tungsteno  
Instruments avec plaquettes en carbure de tungstène  
Strumenti con taglio in carburo di tungsteno

## STERILE R

mit Gamma-Strahlen sterilisierte Produkte  
with gamma radiation sterilized products  
productos esterilizados con rayos gamma  
produits stérilisés avec de rayons gamma  
prodotti sterilizzati con raggi gamma



diamond-coated

Diamantierte Arbeitsenden  
Diamond-coated working ends  
Extremos de trabajo diamantados  
Extrémités de travail diamantées  
Estremità operative diamantate



safety-wave

Safety-Wave-Sicherheitsschluss  
Safety-Wave safety pivot  
Cierre de seguridad Safety-Wave  
Fermeture sécurisée Safety-Wave  
Arresto di sicurezza Safety-Wave



Counter Balance

Counter Balance

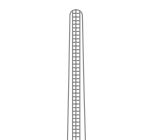

Atrauma

Atrauma-Zahnung  
Atraumatic serration  
Dentado atraumático  
Dentelure Atrauma  
Dentatura atraumatica



VD

Gefäßdilatoren  
Vessel dilators  
Dilatadores vasculares  
Pincés à dilatation de vaisseaux  
Dilatatori vascolari

Pyramiden-Profil Diamond profile Perfil piramidal Profil pyramidal Profilo piramidale	Teilung Profile structure División Division Divisione	empfohlen für Nahtmaterial recommended for suture material recomendado para suturas recommandé pour matériel de suture raccomodato per materiale di sutura
Standard	0,5 mm	0-6 - 4-0
Mini	0,4 mm	4-0 - 6-0
Micro	0,3 mm	5-0 - 12-0
Smooth	-	5-0 - 12-0

Übersichtstafel  
Table of Contents  
Tabla de catálogo  
Contenu  
Indice di catalogo



# Übersichtstafel

Table of Contents

Tabla de catálogo

Contenu

Indice di catalogo

1-22

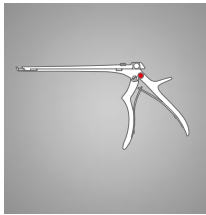

Laminektomiestanzen und Rongeure  
Laminectomy punches and rongeurs  
Pinzas cortantes para laminectomía  
Pincés emporte-pièces à laminectomie et rongeurs  
Pinze taglienti per laminectomia e pinze per afferrare

23-34

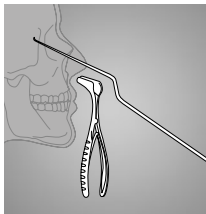

Hypophysen- und Schädelbasis-Chirurgie  
Pituitary und Schädelbasis surgery  
Cirugía para hipófisis und Schädelbasis  
Chirurgie de l'hypophyse und Schädelbasis  
Chirurgia per l'ipofisi und Schädelbasis

35-74

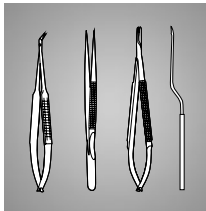

Mikro-Instrumente  
Micro instruments  
Micro-instrumentos  
Micro-instruments  
Micro-strumenti

37-44

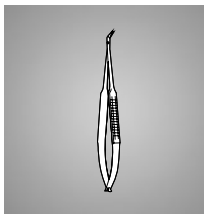

Mikro-Scheren  
Micro Scissors  
Micro-Tijeras  
Micro-Ciseaux  
Micro-Forbici

45-50

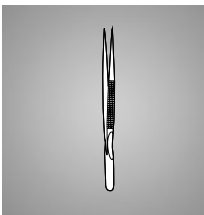

Mikro-Pinzetten  
Micro Forceps  
Micro-Pinzas  
Micro-Pincés  
Micro-Pinze

51-62

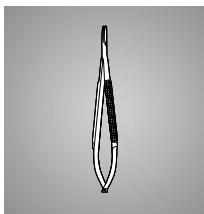

Mikro-Nadelhalter  
Micro Needle Holders  
Micro-Porta-agujas  
Micro-Porte-aiguilles  
Micro-Portaghi

63-74

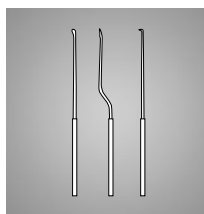

Mikro-Instrumente  
Micro instruments  
Micro-instrumentos  
Micro-instruments  
Micro-strumenti



75-311



Allgemeines Instrumentarium  
General instruments  
Instrumentos generales  
Instrumentation générale  
Strumentario generale

77-82



Skalpelle  
Scalpels  
Bisturíes  
Bistouris  
Bisturi

83-134



Scheren  
Scissors  
Tijeras  
Ciseaux  
Forbici

135-148



Pinzetten  
Forceps  
Pinzas  
Pinces  
Pinze

149-166



Klemmen  
Forceps  
Pinzas  
Pinces  
Pinze

167-220

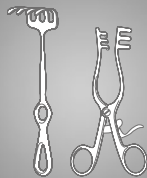

Wundhaken, Halte- und Spreizsysteme  
Retractors, Holding and spreading systems  
Separadores, Sistemas de sujeción y dispersión  
Ecarteurs, Systèmes de maintien et d'épandage  
Divaricatori, Sistemi di tenuta e diffusione

221-223

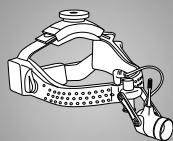

Diagnostik  
Diagnostics  
Diagnóstico  
Diagnostic  
Diagnostica

# Übersichtstafel

Table of Contents

Tabla de catálogo

Contenu

Indice di catalogo

225-239

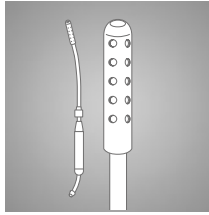

Sauger, Kanülen  
Suction Tubes, Cannulas  
Tubos de Aspiración, Cánulas  
Tubes d'aspiration, Canules  
Tubi d'aspirazione, Cannule

241-247

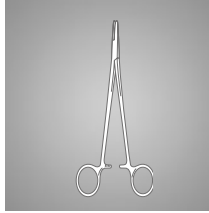

Naht  
Suture  
Sutura  
Suture  
Sutura

249-311

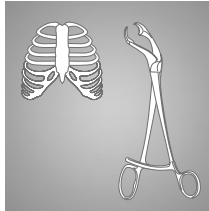

Knochenchirurgie  
Bone Surgery  
Cirugía ósea  
Chirurgie osseuse  
Chirurgia ossea

313-324



HF-Chirurgie  
HF Surgery  
Cirugía AF  
Chirurgie HF  
Chirurgia AF

325-331

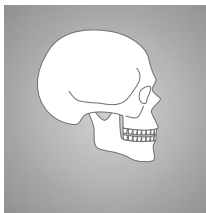

Mund-, Kiefer- und Gesichtschirurgie  
Oral Maxillo-facial Surgery  
Cirugía oral y maxilofacial  
Chirurgie buccale et maxillo-faciale  
Chirurgia maxillo-facciale

333-341



Index  
Index  
Indice  
Index  
Indice

**Weitere Kataloge von KLS Martin**

Zu den folgenden Produktgruppen sind jeweils eigene Kataloge verfügbar, die Sie gerne bei uns anfordern können:

**Further catalogs of KLS Martin**

For the following product groups additional catalogs are available. Please ask for your personal copy:

**Más catálogos de KLS Martin**

Para los grupos siguientes tenemos catálogos individuales disponibles. No duden pedirnos más ejemplares:

**Autres catalogues de KLS Martin**

Pour les groupes de produits suivants sont disponibles des catalogues additionnels dont vous pouvez demander le nombre désiré:

**Altri cataloghi di KLS Martin**

Per i gruppi di prodotti seguenti sono disponibili cataloghi addizionali. La preghiamo di informarci se desidera altre copie:

Deckenversorgungseinheiten  
Ceiling-mounting systems  
Unidades de alimentación de techo  
Unités d'alimentation montées au plafond  
Sistemi pensili

OP-Leuchten  
Operating Theatre Lights  
Lámparas de quirófano  
Lampes opératoires  
Lampade scialitiche

HF-Chirurgie  
HF Surgery  
Cirugía AF  
Chirurgie HF  
Chirurgia AF

Mund-, Kiefer- und Gesichtschirurgie  
Oral and Craniomaxillofacial surgery  
Cirugía oral y maxilofacial  
Chirurgie orale et maxillofaciale  
Chirurgia orale e maxillofacciale

Steriltechnik  
Sterile Technology  
Técnica de esterilización  
Technologie stérile  
Tecnica di sterilizzazione



Laminektomiestanzen und Rongeurs  
Laminectomy punches and rongeurs  
Pinzas cortantes para laminectomía  
Pincés emporte-pièces à laminectomie et rongeurs  
Pinze taglienti per laminectomia e pinze per afferrare

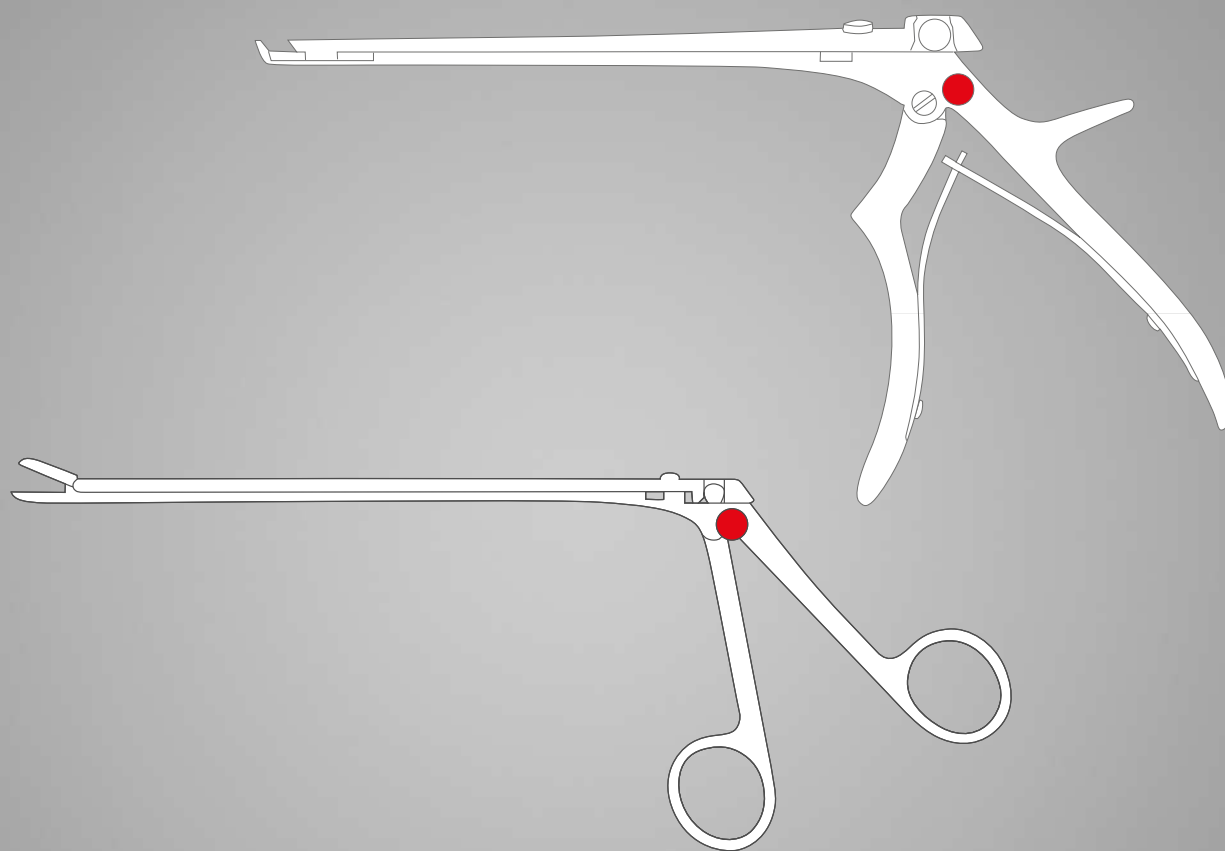

## Laminektomiestanzen

Laminectomy Punches

Pinzas cortantes para laminectomía

Pinces emporte-pièces à laminectomie

Pinze taglianti per laminectomia

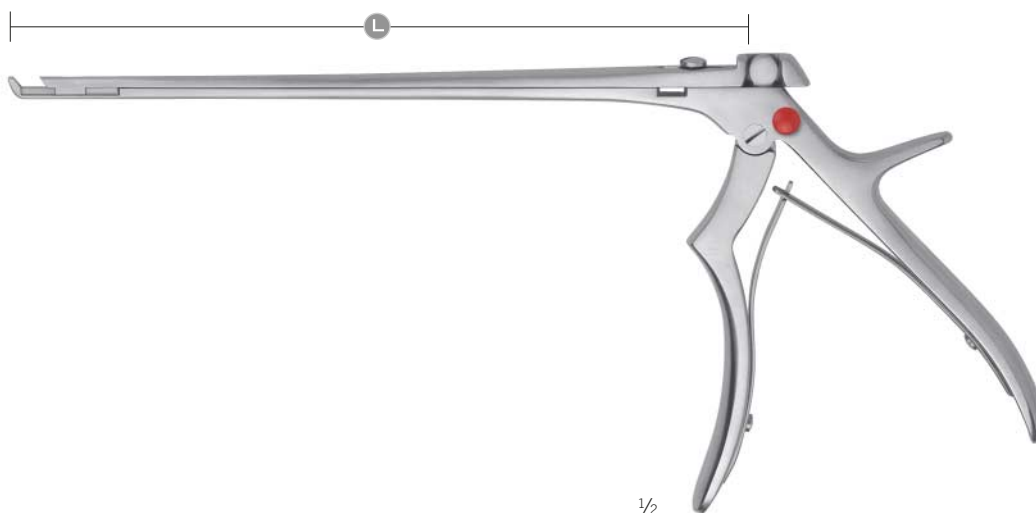

### Ferris-Smith-Kerrison

24-978-01-07 -

24-978-48-14

Stanze mit Auswerfer, zerlegbar

Punch, with ejector, detachable

Perforador con eyector, desmontable

Perforateur avec éjecteur, démontable

Pinze taglianti con espulsore, smontabile

Maulbreite Jaw width Anchura de la boca Largeur de mors Larghezza della bocca		40° aufwärts schneidend cutting upward corte arriba tranchant vers le haut tagliante verso l'alto				90° aufwärts schneidend cutting upward corte arriba tranchant vers le haut tagliante verso l'alto				
		L	18 cm	20 cm	23 cm	28 cm	18 cm	20 cm	23 cm	28 cm
1 mm	○	St	24-978-01-07	24-978-03-07	24-978-05-07	24-978-07-07	24-978-02-07	24-978-04-07	24-978-06-07	24-978-08-07
		SB	24-978-01-14	24-978-03-14	24-978-05-14	24-978-07-14	24-978-02-14	24-978-04-14	24-978-06-14	24-978-08-14
2 mm	◐	St	24-978-09-07	24-978-11-07	24-978-13-07	24-978-15-07	24-978-10-07	24-978-12-07	24-978-14-07	24-978-16-07
		SB	24-978-09-14	24-978-11-14	24-978-13-14	24-978-15-14	24-978-10-14	24-978-12-14	24-978-14-14	24-978-16-14
3 mm	◑	St	24-978-17-07	24-978-19-07	24-978-21-07	24-978-23-07	24-978-18-07	24-978-20-07	24-978-22-07	24-978-24-07
		SB	24-978-17-14	24-978-19-14	24-978-21-14	24-978-23-14	24-978-18-14	24-978-20-14	24-978-22-14	24-978-24-14
4 mm	◒	St	24-978-25-07	24-978-27-07	24-978-29-07	24-978-31-07	24-978-26-07	24-978-28-07	24-978-30-07	24-978-32-07
		SB	24-978-25-14	24-978-27-14	24-978-29-14	24-978-31-14	24-978-26-14	24-978-28-14	24-978-30-14	24-978-32-14
5 mm	◓	St	24-978-33-07	24-978-35-07	24-978-37-07	24-978-39-07	24-978-34-07	24-978-36-07	24-978-38-07	24-978-40-07
		SB	24-978-33-14	24-978-35-14	24-978-37-14	24-978-39-14	24-978-34-14	24-978-36-14	24-978-38-14	24-978-40-14
6 mm	◔	St	24-978-41-07	24-978-43-07	24-978-45-07	24-978-47-07	24-978-42-07	24-978-44-07	24-978-46-07	24-978-48-07
		SB	24-978-41-14	24-978-43-14	24-978-45-14	24-978-47-14	24-978-42-14	24-978-44-14	24-978-46-14	24-978-48-14

## Laminektomiestanzen

Laminectomy Punches

Pinzas cortantes para laminectomía

Pinces emporte-pièces à laminectomie

Pinze taglianti per laminectomia

## Laminektomiestanzen und Rongeurs

Laminectomy punches and rongeurs

Pinzas cortantes para laminectomía

Pinces emporte-pièces à laminectomie et rongeurs

Pinze taglianti per laminectomia e pinze per afferrare

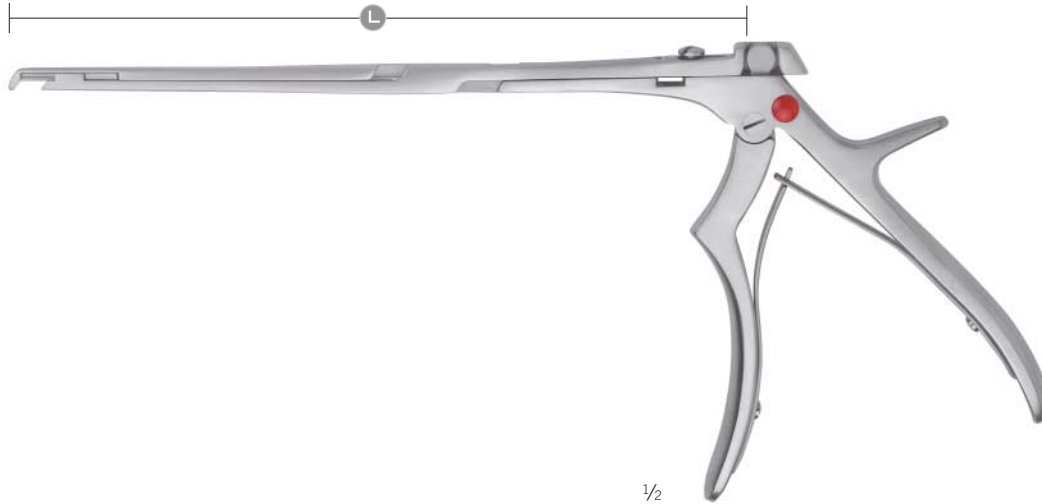
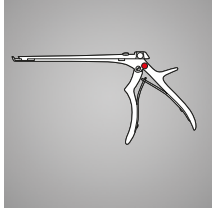

### Ferris-Smith-Kerrison

24-978-50-07 -

24-978-85-14

Stanze mit Auswerfer, zerlegbar

Punch, with ejector, detachable

Perforador con eyector, desmontable

Perforateur avec éjecteur, démontable

Pinze taglianti con espulsore, smontabile

Maulbreite Jaw width Anchura de la boca Largeur de mors Larghezza della bocca		40° abwärts schneidend cutting downward desmontable, corte abajo tranchant vers le bas tagliante verso il basso			90° abwärts schneidend cutting downward desmontable, corte abajo tranchant vers le bas tagliante verso il basso			
		L	18 cm	20 cm	23 cm	18 cm	20 cm	23 cm
1 mm	□	St	24-978-50-07	24-978-52-07	24-978-54-07	24-978-51-07	24-978-53-07	24-978-55-07
		SB	24-978-50-14	24-978-52-14	24-978-54-14	24-978-51-14	24-978-53-14	24-978-55-14
2 mm	◐	St	24-978-56-07	24-978-58-07	24-978-60-07	24-978-57-07	24-978-59-07	24-978-61-07
		SB	24-978-56-14	24-978-58-14	24-978-60-14	24-978-57-14	24-978-59-14	24-978-61-14
3 mm	◑	St	24-978-62-07	24-978-64-07	24-978-66-07	24-978-63-07	24-978-65-07	24-978-67-07
		SB	24-978-62-14	24-978-64-14	24-978-66-14	24-978-63-14	24-978-65-14	24-978-67-14
4 mm	◒	St	24-978-68-07	24-978-70-07	24-978-72-07	24-978-69-07	24-978-71-07	24-978-73-07
		SB	24-978-68-14	24-978-70-14	24-978-72-14	24-978-69-14	24-978-71-14	24-978-73-14
5 mm	◓	St	24-978-74-07	24-978-76-07	24-978-78-07	24-978-75-07	24-978-77-07	24-978-79-07
		SB	24-978-74-14	24-978-76-14	24-978-78-14	24-978-75-14	24-978-77-14	24-978-79-14
6 mm	◔	St	24-978-80-07	24-978-82-07	24-978-84-07	24-978-81-07	24-978-83-07	24-978-85-07
		SB	24-978-80-14	24-978-82-14	24-978-84-14	24-978-81-14	24-978-83-14	24-978-85-14

## Laminektomiestanzen

Laminectomy Punches

Pinzas cortantes para laminectomía

Pinces emporte-pièces à laminectomie

Pinze taglienti per laminectomia

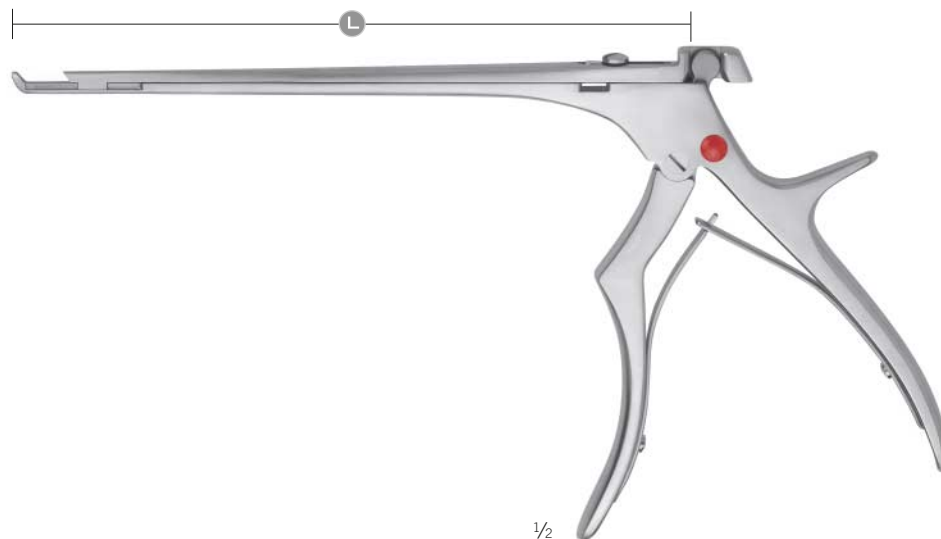

### Ferris-Smith-Kerrison

24-978-90-07 -

24-978-95-14







Stanze mit Auswerfer, zerlegbar, **Langhub**

Punch, with ejector, detachable, **long stroke**

Perforador con eyector, desmontable, **carrera larga**

Perforateur avec éjecteur, démontable, **course longue**

Pinze taglienti con espulsore, smontabile, **corsa lunga**

Maulbreite Jaw width Anchura de la boca Largeur de mors Larghezza della bocca	40° aufwärts schneidend cutting upward corte arriba tranchant vers le haut tagliente verso l'alto	
1 mm 	<b>L</b> <b>18 cm</b>	
	<b>St</b> 24-978-90-07	
	<b>SB</b> 24-978-90-14	
2 mm 	<b>St</b> 24-978-91-07	
	<b>SB</b> 24-978-91-14	
3 mm 	<b>St</b> 24-978-92-07	
	<b>SB</b> 24-978-92-14	
4 mm 	<b>St</b> 24-978-93-07	
	<b>SB</b> 24-978-93-14	
5 mm 	<b>St</b> 24-978-94-07	
	<b>SB</b> 24-978-94-14	
6 mm 	<b>St</b> 24-978-95-07	
	<b>SB</b> 24-978-95-14	



## Laminectomiestanzen

Laminectomy Punches

Pinzas cortantes para laminectomía

Pinces emporte-pièces à laminectomie

Pinze taglianti per laminectomia

## Laminectomiestanzen und Rongeurs

Laminectomy punches and rongeurs

Pinzas cortantes para laminectomía

Pinces emporte-pièces à laminectomie et rongeurs

Pinze taglianti per laminectomia e pinze per afferrare

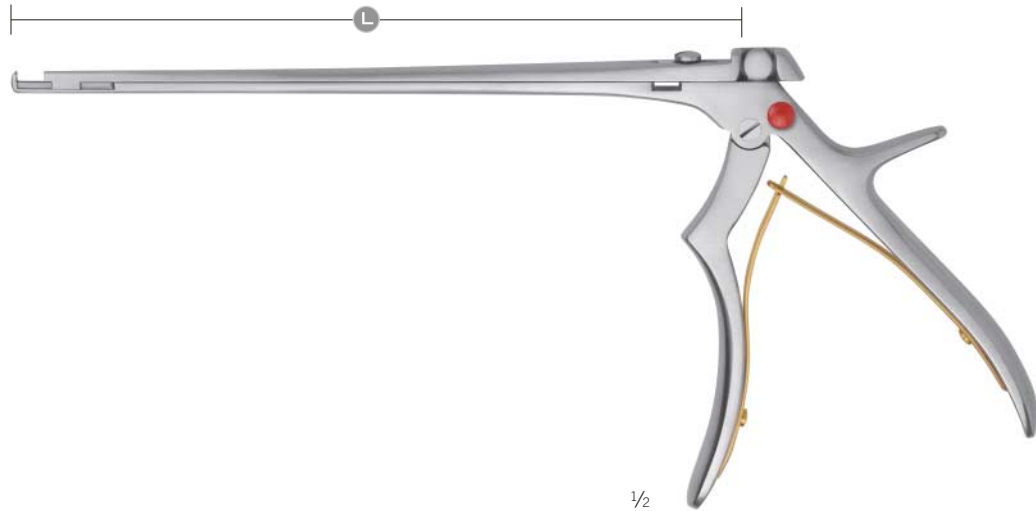
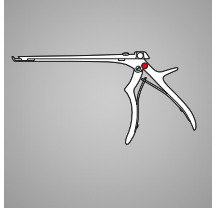

### Ferris-Smith-Kerrison

24-979-01-07 -

24-979-48-14

Stanze mit Auswerfer, zerlegbar, **dünne Platte**

Punch, with ejector, detachable, **thin plate**

Perforador con eyector, desmontable, **placa delgada**

Perforateur avec éjecteur, démontable, **plaque mince**

Pinze taglianti con espulsore, smontabile, **piastra sottile**

Maulbreite Jaw width Anchura de la boca Largeur de mors Larghezza della bocca		40° aufwärts schneidend cutting upward corte arriba tranchant vers le haut tagliante verso l'alto				90° aufwärts schneidend cutting upward corte arriba tranchant vers le haut tagliante verso l'alto				
		L	18 cm	20 cm	23 cm	28 cm	18 cm	20 cm	23 cm	28 cm
1 mm	□	St	24-979-01-07	24-979-03-07	24-979-05-07	24-979-07-07	24-979-02-07	24-979-04-07	24-979-06-07	24-979-08-07
		SB	24-979-01-14	24-979-03-14	24-979-05-14	24-979-07-14	24-979-02-14	24-979-04-14	24-979-06-14	24-979-08-14
2 mm	◐	St	24-979-09-07	24-979-11-07	24-979-13-07	24-979-15-07	24-979-10-07	24-979-12-07	24-979-14-07	24-979-16-07
		SB	24-979-09-14	24-979-11-14	24-979-13-14	24-979-15-14	24-979-10-14	24-979-12-14	24-979-14-14	24-979-16-14
3 mm	◑	St	24-979-17-07	24-979-19-07	24-979-21-07	24-979-23-07	24-979-18-07	24-979-20-07	24-979-22-07	24-979-24-07
		SB	24-979-17-14	24-979-19-14	24-979-21-14	24-979-23-14	24-979-18-14	24-979-20-14	24-979-22-14	24-979-24-14
4 mm	◒	St	24-979-25-07	24-979-27-07	24-979-29-07	24-979-31-07	24-979-26-07	24-979-28-07	24-979-30-07	24-979-32-07
		SB	24-979-25-14	24-979-27-14	24-979-29-14	24-979-31-14	24-979-26-14	24-979-28-14	24-979-30-14	24-979-32-14
5 mm	◓	St	24-979-33-07	24-979-35-07	24-979-37-07	24-979-39-07	24-979-34-07	24-979-36-07	24-979-38-07	24-979-40-07
		SB	24-979-33-14	24-979-35-14	24-979-37-14	24-979-39-14	24-979-34-14	24-979-36-14	24-979-38-14	24-979-40-14
6 mm	◔	St	24-979-41-07	24-979-43-07	24-979-45-07	24-979-47-07	24-979-42-07	24-979-44-07	24-979-46-07	24-979-48-07
		SB	24-979-41-14	24-979-43-14	24-979-45-14	24-979-47-14	24-979-42-14	24-979-44-14	24-979-46-14	24-979-48-14

## Laminektomiestanzen

Laminectomy Punches

Pinzas cortantes para laminectomía

Pinces emporte-pièces à laminectomie

Pinze taglienti per laminectomia

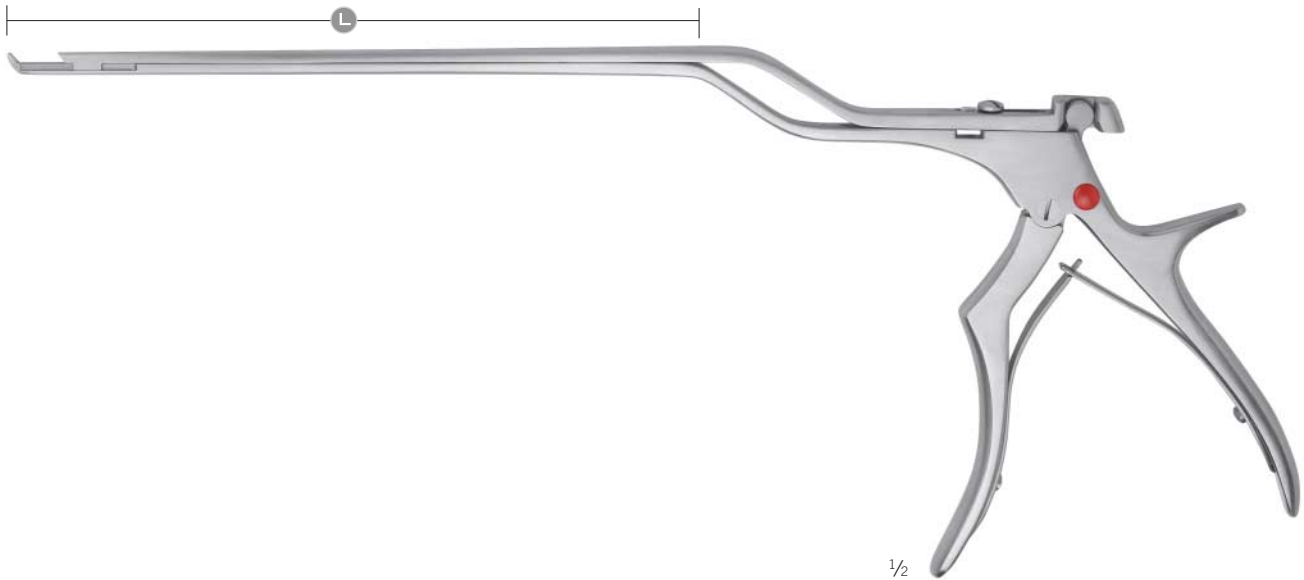

Ferris-Smith-Kerrison

24-980-21-07 -

24-980-25-14

Stanze mit Auswerfer, zerlegbar, **Langhub**

Punch, with ejector, detachable, **long stroke**

Perforador con eyector, desmontable, **carrera larga**

Perforateur avec éjecteur, démontable, **course longue**

Pinze taglienti con espulsore, smontabile, **corsa lunga**

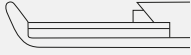
Maulbreite Jaw width Anchura de la boca Largeur de mors Larghezza della bocca		40° aufwärts schneidend, bajonett cutting upward, bayonet corte arriba, bayoneta tranchant vers le haut, baïonnette tagliente verso l'alto, baionetta	
	<b>L</b>	<b>18 cm</b>	
1 mm	<b>St</b>	24-980-21-07	
	<b>SB</b>	24-980-21-14	
2 mm	<b>St</b>	24-980-22-07	
	<b>SB</b>	24-980-22-14	
3 mm	<b>St</b>	24-980-23-07	
	<b>SB</b>	24-980-23-14	
4 mm	<b>St</b>	24-980-24-07	
	<b>SB</b>	24-980-24-14	
5 mm	<b>St</b>	24-980-25-07	
	<b>SB</b>	24-980-25-14	

## Laminektomiestanzen

Laminectomy Punches

Pinzas cortantes para laminectomía

Pinces emporte-pièces à laminectomie

Pinze taglianti per laminectomia

## Laminektomiestanzen und Rongeurs

Laminectomy punches and rongeurs

Pinzas cortantes para laminectomía

Pinces emporte-pièces à laminectomie et rongeurs

Pinze taglianti per laminectomia e pinze per afferrare

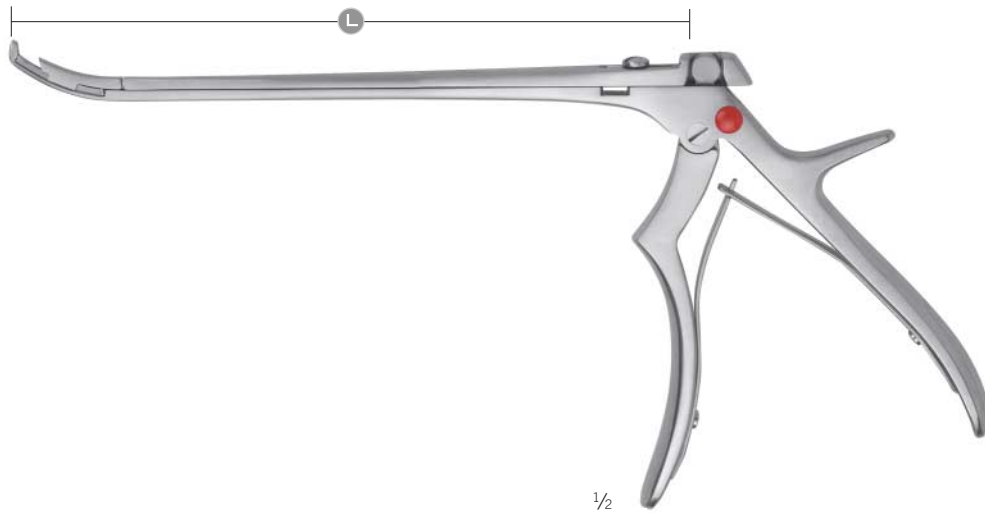
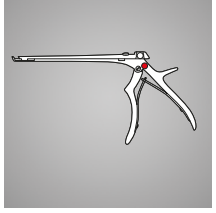

Ferris-Smith-Kerrison

24-980-30-07 -

24-980-44-14

Stanze mit Auswerfer, zerlegbar

Punch, with ejector, detachable

Perforador con eyector, desmontable

Perforateur avec éjecteur, démontable

Pinze taglianti con espulsore, smontabile

Maulbreite Jaw width Anchura de la boca Largeur de mors Larghezza della bocca		40° aufwärts gebogen curved upward curvo arriba coudé vers le haut curva verso l'alto		40° links gebogen curved leftwards curvo izquierda coudé à gauche curva a sinistra		40° rechts gebogen curved rightwards curvo derecha coudé à droite curva a destra	
		$\frac{1}{2}$	$\frac{1}{2}$	$\frac{1}{2}$	$\frac{1}{2}$		
		<b>L</b>	<b>20 cm</b>	<b>20 cm</b>	<b>20 cm</b>		
1 mm	□	St	24-980-30-07	24-980-31-07	24-980-32-07		
		SB	24-980-30-14	24-980-31-14	24-980-32-14		
2 mm	◐	St	24-980-33-07	24-980-34-07	24-980-35-07		
		SB	24-980-33-14	24-980-34-14	24-980-35-14		
3 mm	◑	St	24-980-36-07	24-980-37-07	24-980-38-07		
		SB	24-980-36-14	24-980-37-14	24-980-38-14		
4 mm	◒	St	24-980-39-07	24-980-40-07	24-980-41-07		
		SB	24-980-39-14	24-980-40-14	24-980-41-14		
5 mm	◓	St	24-980-42-07	24-980-43-07	24-980-44-07		
		SB	24-980-42-14	24-980-43-14	24-980-44-14		

## Laminektomiestanzen

Laminectomy Punches

Pinzas cortantes para laminectomía

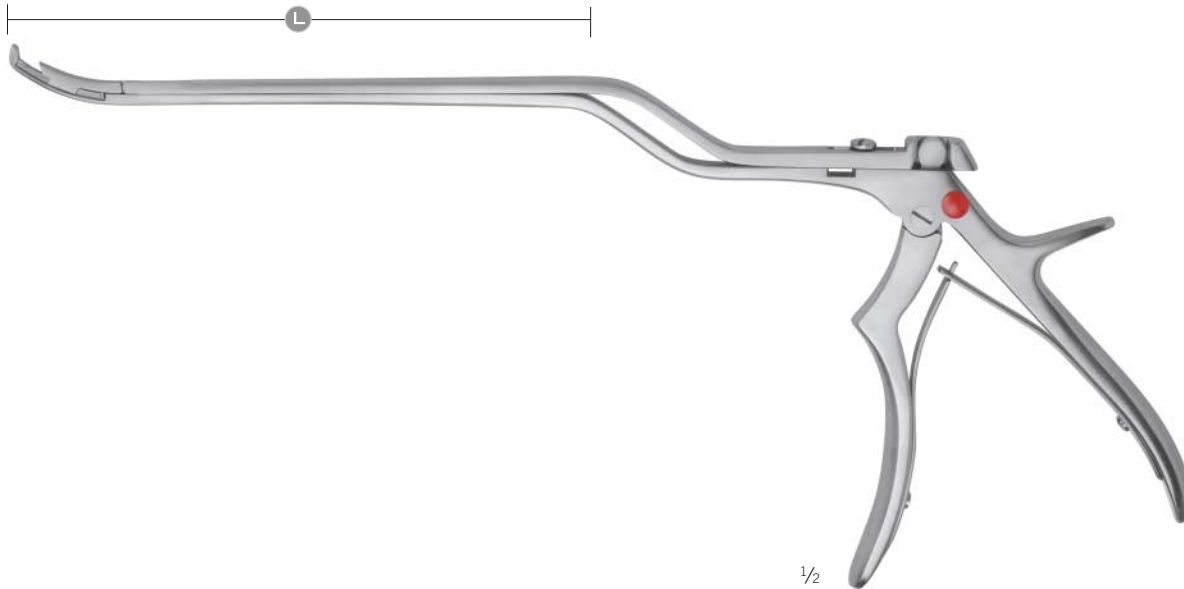

Pincès emporte-pièces à laminectomie

Pinze taglianti per laminectomia

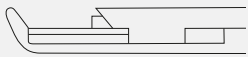

Ferris-Smith-Kerrison  
24-980-50-07

Stanze mit Auswerfer, zerlegbar  
Punch, with ejector, detachable  
Perforador con eyector, desmontable  
Perforateur avec éjecteur, démontable  
Pinze taglianti con espulsore, smontabile

<p><b>Maulbreite</b> <b>Jaw width</b> <b>Anchura de la boca</b> <b>Largeur de mors</b> <b>Larghezza della bocca</b></p>	<p><b>40°</b> <b>gebogen, bajonett</b> <b>curved, bayonet</b> <b>curvo, bayoneta</b> <b>coudé, baïonnette</b> <b>curva, baionetta</b></p>	<p><math>\frac{1}{1}</math> </p>
<p><b>3 mm</b> </p>	<p><b>L</b> <b>15 cm</b> <b>St</b> <b>24-980-50-07</b></p>	

## Zerlegen der Instrumente

Instrument disassembly  
Desmontaje de los instrumentos  
Démontage des instruments  
Smontaggio degli strumenti

## Laminectomiestanzen und Rongeurs

Laminectomy punches and rongeurs  
Pinzas cortantes para laminectomía  
Pincas emporte-pièces à laminectomie et rongeurs  
Pinze taglienti per laminectomia e pinze per afferrare

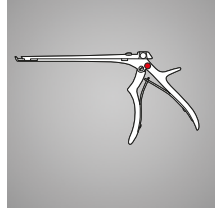

### Anweisung zum Öffnen

1. Griff schließen.
2. Knopf drücken und gedrückt halten.
3. Griff wieder öffnen. Druck auf roten Knopf beibehalten.
4. Das obere Schieberteil ist entriegelt und kann nach links ausgeschwenkt werden.



### Disassembly Instructions

1. Close the handle.
2. Push the button and keep it pushed.
3. Release quickly the front part of the handle.
4. The upper movable shaft is unlocked and can be slid to the left.



### Instrucciones de apertura

1. Cerrar el mango.
2. Presionar el botón y mantenerlo pulsado.
3. Volver a abrir el mango.
4. El vástago superior corredero desengrana y puede girarse hacia la izquierda.



### Consigne d'ouverture

1. Refermez le manche.
2. Appuyez sur le bouton et maintenez-le enfoncé.
3. Rouvrez le manche.
4. La partie supérieure du curseur est débloquée et peut être pivotée vers la gauche.



### Istruzioni per l'apertura

1. Chiudere l'impugnatura.
2. Premere e tenere premuto il pulsante.
3. Riaprire l'impugnatura.
4. La parte superiore scorrevole si sblocca e può essere ruotata a sinistra.

### Hinweis

Durch nochmaliges Schließen des Griffes bleibt der Schaft ausgeschwenkt und das Instrument kann in offenem Zustand sterilisiert werden.

### Advice

If the handle is closed again, the shaft remains swivelled out so that the instrument can be sterilized in open position.

### Nota

Al volver a cerrar el mango de forma normal, el vástago gira y el instrumento puede esterilizarse abierto.

### Remarque

En refermant une nouvelle fois le manche, la tige pivotée reste en position et l'instrument ainsi ouvert peut être stérilisé.

### Nota

Richiudendo l'impugnatura il gambo resta ruotato, in modo da consentire la sterilizzazione dello strumento aperto.

### Zusammensetzen

1. Griff schließen.
2. Knopf drücken und gedrückt halten.
3. Griff öffnen, Schieber einschwenken und nach unten drücken.
4. Griff nochmals schließen – das Instrument ist verriegelt.

### Assembly Instructions

1. Close the handle.
2. Push the button and keep it pushed.
3. Open the handle. Slide back the movable shaft on the instrument and push the shaft downward.
4. Close the handle once again and the instrument is locked.

### Montaje

1. Cerrar el mango.
2. Presionar el botón y mantenerlo pulsado.
3. Abrir el mango, girar el vástago hacia el instrumento y presionar hacia abajo.
4. Volver a cerrar el mango. El instrumento está bloqueado de nuevo.

### Assemblage

1. Fermez le manche.
2. Appuyez sur le bouton et maintenez-le enfoncé.
3. Ouvrez le manche, faites pivoter le curseur et appuyez vers le bas.
4. Rouvrez le manche - l'instrument est verrouillé.

### Rimontaggio

1. Chiudere l'impugnatura.
2. Premere e tenere premuto il pulsante.
3. Aprire l'impugnatura, ritrarre la barra scorrevole e premere verso il basso.
4. Richiudere l'impugnatura – lo strumento è bloccato.



## LubriPen 55-997-01-04

für präzises Ölen von chirurgischen Instrumenten und Medizinprodukten  
for precise lubrication of surgical instruments and medical devices  
para una lubricación perfecta de instrumentos quirúrgicos y dispositivos médicos  
Graissage précis d'instruments chirurgicaux et d'équipements médicaux  
Lubrificazione di precisione di strumenti chirurgici e dispositivi medici



Zerlegen der Instrumente  
Instrument disassembly  
Desmontaje de los instrumentos  
Démontage des instruments  
Smontaggio degli strumenti

<https://www.youtube.com/watch?v=90fxTTgmBXw>



## Lagerung Laminektomiestanzen

Storage Laminectomy Punches

Almacenaje para pinzas cortantes para laminectomía

Rangement pour pinces emporte-pièces à laminectomie

Supporto per pinze taglianti per laminectomia



55-803-10-04

480 x 255 x 103 mm

Siebkorb zur Lagerung von Laminektomiestanzen

Mesh tray for storage of laminectomy punches

Bandeja cribada para almacenaje para pinzas cortantes para laminectomía

Panier à maille pour rangement pour pinces emporte-pièces à laminectomie

Vassoi reticolati per supporto per pinze taglianti per laminectomia



Beispiel Bestückung

Configuration example

Ejemplo de equipamiento

Exemple d'agencement

Esempio di strumenti



## Lagerung Laminektomiestanzen

Storage Laminectomy Punches

Almacenaje para pinzas cortantes para laminectomía

Rangement pour pinces emporte-pièces à laminectomie

Supporto per pinze taglienti per laminectomia

## Laminektomiestanzen und Rongeurs

Laminectomy punches and rongeurs

Pinzas cortantes para laminectomía

Pinces emporte-pièces à laminectomie et rongeurs

Pinze taglienti per laminectomia e pinze per afferrare

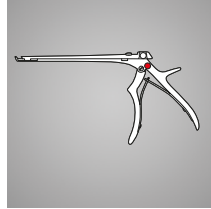

55-803-15-04

535 x 255 x 103 mm

Höhenreduzierter Siebkorb zur Lagerung von 4 Stanzen in besonders niedrigen Lagerungswägen für RDG (Reinigungs- und Desinfektionsgerät)

Lower mesh tray for storing 4 punches in very low mobile units for washer-disinfectors

Bandeja cribada de altura reducida para el almacenaje de 4 perforadores en carros de almacenaje especialmente bajos para máquinas de lavado y desinfección

Panier à mailles à hauteur réduite pour le rangement de 4 poinçons dans des chariots très bas pour laveur-désinfecteur

Vassoio reticolato ad altezza ridotta per il magazzino di 4 pinze taglienti in carrelli di carico particolarmente bassi per apparecchio di pulizia e disinfezione



Beispiel Bestückung

Configuration example

Ejemplo de equipamiento

Exemple d'agencement

Esempio di strumenti



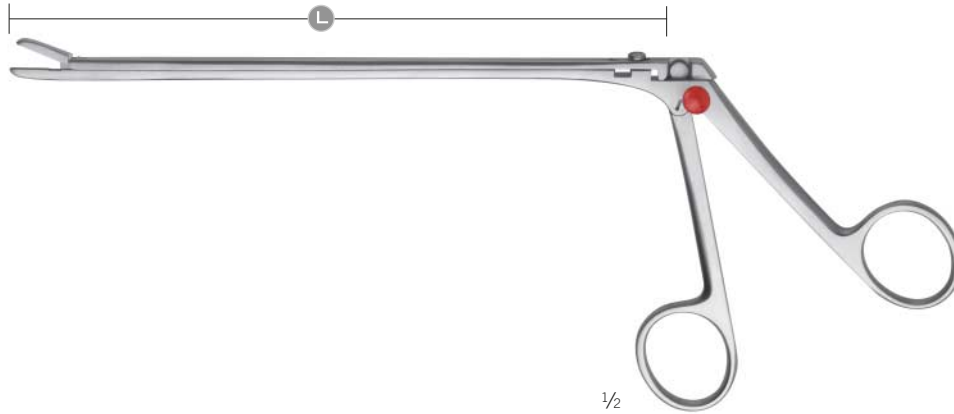

## Rongeur

Rongeurs  
Pinzas cortantes  
Rongeurs  
Pinze per afferrare



Caspar  
24-981-05-07 -  
24-981-16-14

zerlegbar  
detachable  
desmontable  
démontable  
smontabile

Maulbreite Jaw width Anchura de la boca Largeur de mors Larghezza della bocca		gerade straight recto droit diritto		
		L	15 cm	18 cm
2 mm 	St	24-981-05-07	24-981-09-07	24-981-13-07
	SB	24-981-05-14	24-981-09-14	24-981-13-14
3 mm 	St	24-981-06-07	24-981-10-07	24-981-14-07
	SB	24-981-06-14	24-981-10-14	24-981-14-14
4 mm 	St	24-981-07-07	24-981-11-07	24-981-15-07
	SB	24-981-07-14	24-981-11-14	24-981-15-14
5 mm 	St	24-981-08-07	24-981-12-07	24-981-16-07
	SB	24-981-08-14	24-981-12-14	24-981-16-14



## Rongeurs

Rongeurs  
Pinzas cortantes  
Rongeurs  
Pinze per afferrare



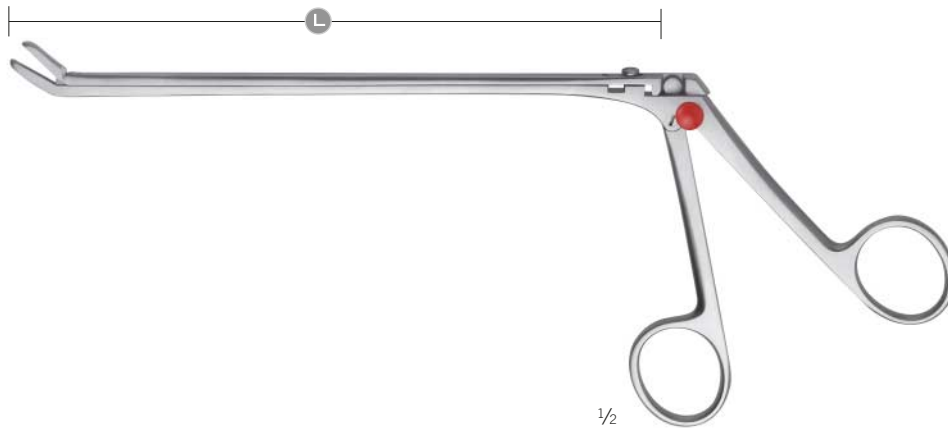
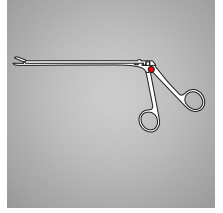

## Laminektomiestanzen und Rongeurs

Laminectomy punches and rongeurs  
Pinzas cortantes para laminectomía  
Pincas emporte-pièces à laminectomie et rongeurs  
Pinze taglianti per laminectomia e pinze per afferrare



Caspar  
24-981-25-07 -  
24-981-36-14

zerlegbar  
detachable  
desmontable  
démontable  
smontabile

Maulbreite Jaw width Anchura de la boca Largeur de mors Larghezza della bocca		30° aufgewinkelt angled upward acodado arrib angulé vers le haut angolato verso l'alto			
		L	15 cm	18 cm	20 cm
2 mm		St	24-981-25-07	24-981-29-07	24-981-33-07
		SB	24-981-25-14	24-981-29-14	24-981-33-14
3 mm		St	24-981-26-07	24-981-30-07	24-981-34-07
		SB	24-981-26-14	24-981-30-14	24-981-34-14
4 mm		St	24-981-27-07	24-981-31-07	24-981-35-07
		SB	24-981-27-14	24-981-31-14	24-981-35-14
5 mm		St	24-981-28-07	24-981-32-07	24-981-36-07
		SB	24-981-28-14	24-981-32-14	24-981-36-14

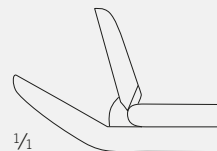



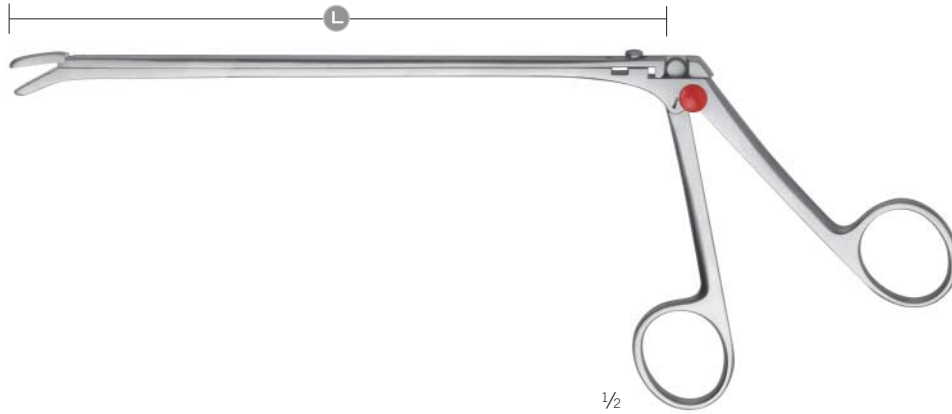

## Rongeur

Rongeurs  
Pinzas cortantes  
Rongeurs  
Pinze per afferrare



Caspar  
24-981-45-07 -  
24-981-56-14

zerlegbar  
detachable  
desmontable  
démontable  
smontabile

Maulbreite Jaw width Anchura de la boca Largeur de mors Larghezza della bocca		30° abgewinkelt angled downward acodado abajo angulé vers le bas angolato verso il basso			
		L	15 cm	18 cm	20 cm
2 mm		St	24-981-45-07	24-981-49-07	24-981-53-07
	SB	24-981-45-14	24-981-49-14	24-981-53-14	
3 mm		St	24-981-46-07	24-981-50-07	24-981-54-07
	SB	24-981-46-14	24-981-50-14	24-981-54-14	
4 mm		St	24-981-47-07	24-981-51-07	24-981-55-07
	SB	24-981-47-14	24-981-51-14	24-981-55-14	
5 mm		St	24-981-48-07	24-981-52-07	24-981-56-07
	SB	24-981-48-14	24-981-52-14	24-981-56-14	

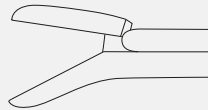

## Rongeurs

Rongeurs  
Pinzas cortantes  
Rongeurs  
Pinze per afferrare



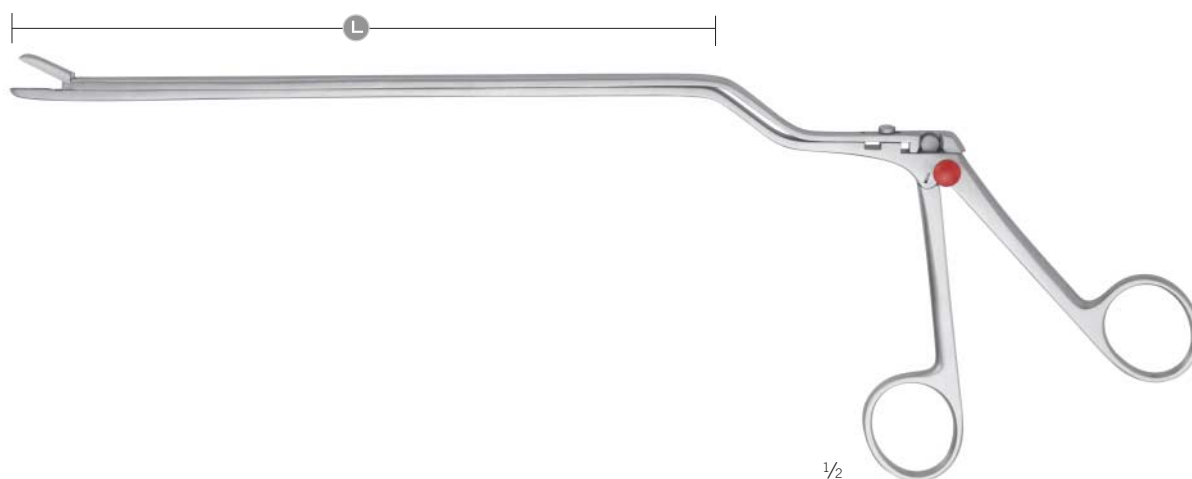
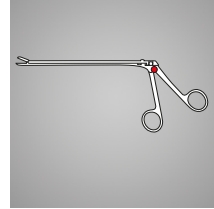

## Laminektomiestanzen und Rongeurs

Laminectomy punches and rongeurs  
Pinzas cortantes para laminectomía  
Pinces emporte-pièces à laminectomie et rongeurs  
Pinze taglianti per laminectomia e pinze per afferrare

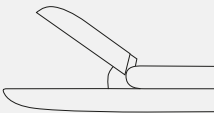

Caspar  
24-981-65-07 -  
24-981-68-14

zerlegbar  
detachable  
desmontable  
démontable  
smontabile

Maulbreite Jaw width Anchura de la boca Largeur de mors Larghezza della bocca		gerade, bajonett straight, bayonet recto, bayoneta droit, baïonnette diritto, baionetta	
		<b>L</b>	<b>18 cm</b>
2 mm		<b>St</b>	24-981-65-07
		<b>SB</b>	24-981-65-14
3 mm		<b>St</b>	24-981-66-07
		<b>SB</b>	24-981-66-14
4 mm		<b>St</b>	24-981-67-07
		<b>SB</b>	24-981-67-14
5 mm		<b>St</b>	24-981-68-07
		<b>SB</b>	24-981-68-14



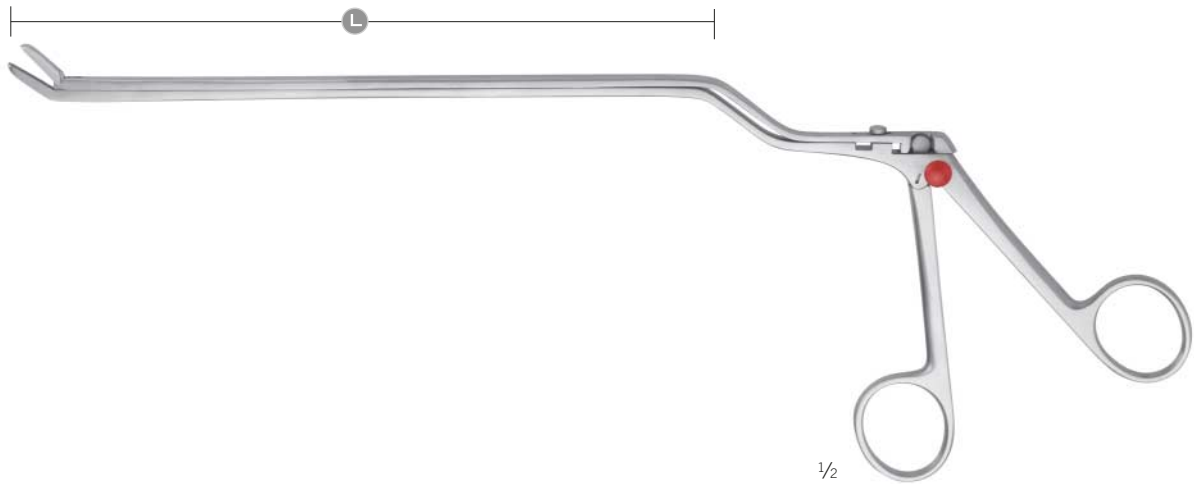

## Rongeur

Rongeurs  
Pinzas cortantes  
Rongeurs  
Pinze per afferrare

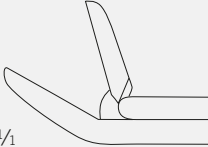

Caspar  
24-981-75-07 -  
24-981-78-14

zerlegbar  
detachable  
desmontable  
démontable  
smontabile

Maulbreite Jaw width Anchura de la boca Largeur de mors Larghezza della bocca		30° aufgewinkelt, bajonett angled upward, bayonet acodado arriba, bayoneta angulé vers le haut, baïonnette angolato verso l'alto, baionetta	
	<b>L</b>	<b>18 cm</b>	
2 mm		<b>St</b> 24-981-75-07 <b>SB</b> 24-981-75-14	
3 mm		<b>St</b> 24-981-76-07 <b>SB</b> 24-981-76-14	
4 mm		<b>St</b> 24-981-77-07 <b>SB</b> 24-981-77-14	
5 mm		<b>St</b> 24-981-78-07 <b>SB</b> 24-981-78-14	

## Rongeurs

Rongeurs  
Pinzas cortantes  
Rongeurs  
Pinze per afferrare

## Laminectomiestanzen und Rongeurs

Laminectomy punches and rongeurs  
Pinzas cortantes para laminectomía  
Pinces emporte-pièces à laminectomie et rongeurs  
Pinze taglianti per laminectomia e pinze per afferrare

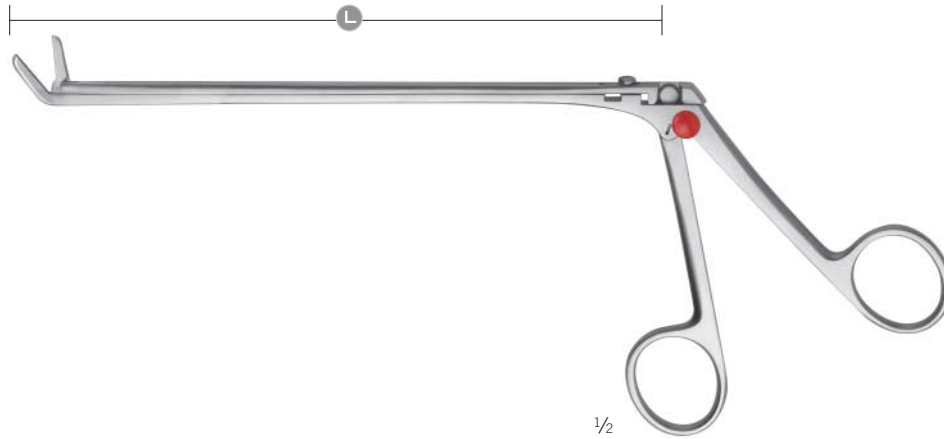
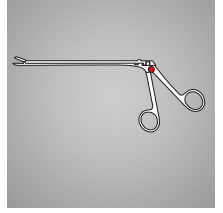

Caspar  
24-981-80-07 -  
24-981-83-14

zerlegbar  
detachable  
desmontable  
démontable  
smontabile



<b>Maulbreite</b> <b>Jaw width</b> <b>Anchura de la boca</b> <b>Largeur de mors</b> <b>Larghezza della bocca</b>		<b>50° aufgewinkelt</b> <b>angled upward</b> <b>acodado arrib</b> <b>angulé vers le haut</b> <b>angolato verso l'alto</b>			<b>50° abgewinkelt</b> <b>angled downward</b> <b>acodado abajo</b> <b>angulé vers le bas</b> <b>angolato verso il basso</b>	
<b>4 mm</b>		<b>L</b>	<b>18 cm</b>	<b>30 cm</b>	<b>18 cm</b>	<b>30 cm</b>
		<b>St</b>	24-981-80-07	24-981-81-07	24-981-82-07	24-981-83-07
		<b>SB</b>	24-981-80-14	24-981-81-14	24-981-82-14	24-981-83-14

# Rongeur

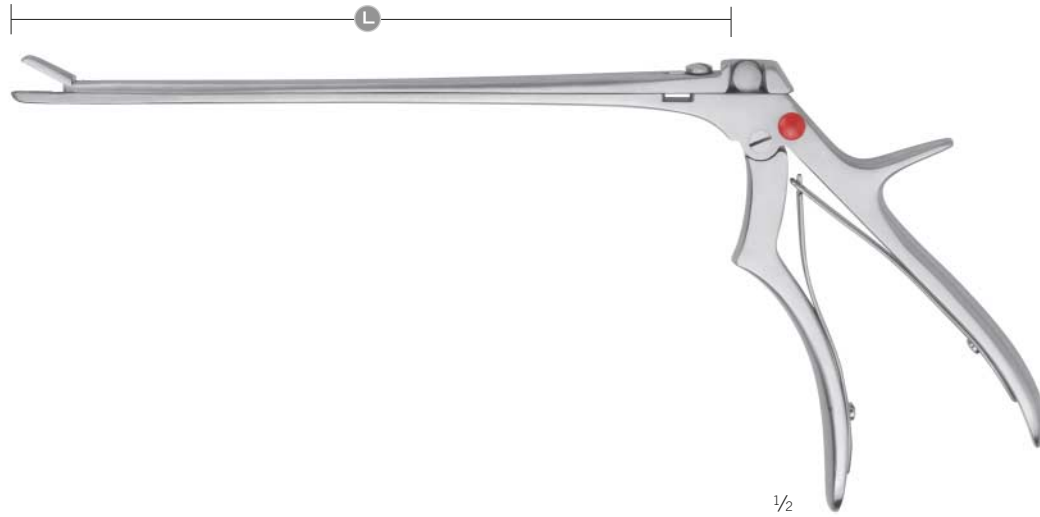
Rongeurs  
Pinzas cortantes  
Rongeurs  
Pinze per afferrare



Wagner  
24-981-91-07 -  
24-981-93-14  
zerlegbar, **kräftig**  
detachable, **strong model**  
desmontable, **robusto**  
démontable, **robuste**  
smontabile, **robusto**

Maulbreite Jaw width Anchura de la boca Largeur de mors Larghezza della bocca		gerade straight recto droit diritto	50° aufgewinkelt angled upward acodado arrib angulé vers le haut angolato verso l'alto		50° abgewinkelt angled downward acodado abajo angulé vers le bas angolato verso il basso	
		$\frac{1}{1}$				
3 mm 	<b>L</b>	<b>20 cm</b>	<b>20 cm</b>	<b>30 cm</b>	<b>20 cm</b>	<b>30 cm</b>
	<b>st</b>	24-981-91-07				
	<b>SB</b>	24-981-91-14				
4 mm 	<b>st</b>	24-981-92-07	24-981-84-07	24-981-85-07	24-981-86-07	24-981-87-07
	<b>SB</b>	24-981-92-14	24-981-84-14	24-981-85-14	24-981-86-14	24-981-87-14
5 mm 	<b>st</b>	24-981-93-07				
	<b>SB</b>	24-981-93-14				

## Rongeur

Rongeurs  
Pinzas cortantes  
Rongeurs  
Pinze per afferrare



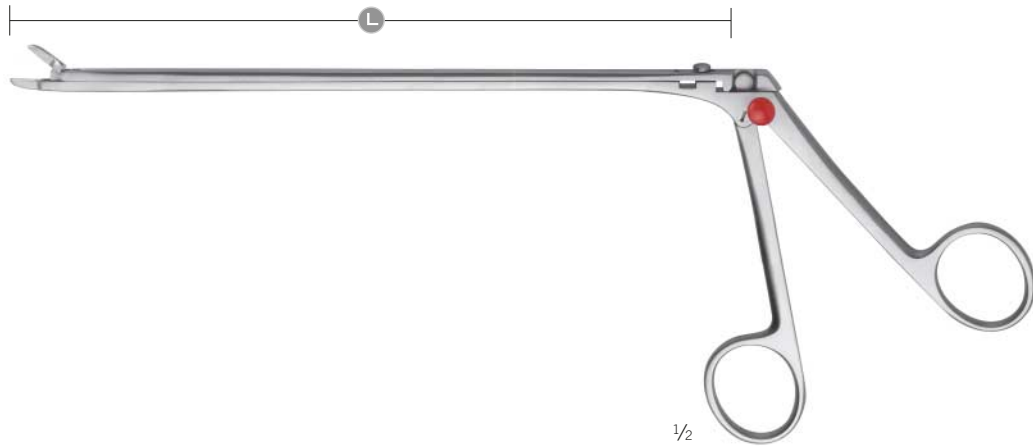
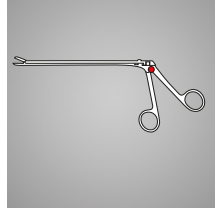

## Laminectomiestanzen und Rongeur

Laminectomy punches and rongeurs  
Pinzas cortantes para laminectomía  
Pinces emporte-pièces à laminectomie et rongeurs  
Pinze taglianti per laminectomia e pinze per afferrare

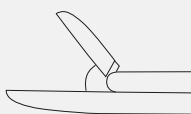

Richter  
24-982-10-07 -  
24-982-13-14

zerlegbar  
detachable  
desmontable  
démontable  
smontabile

Maulbreite Jaw width Anchura de la boca Largeur de mors Larghezza della bocca	gerade straight recto droit diritto		30° aufgewinkelt angled upward acodado arrib angulé vers le haut angolato verso l'alto	
	$\frac{1}{2}$		$\frac{1}{2}$	
1,0 mm 	<b>L</b>	<b>18 cm</b>	<b>18 cm</b>	
	<b>St</b>	24-982-10-07	24-982-11-07	
	<b>SB</b>	24-982-10-14	24-982-11-14	
1,5 mm 	<b>St</b>	24-982-12-07	24-982-13-07	
	<b>SB</b>	24-982-12-14	24-982-13-14	

## Lagerung Rongeure

Storage Rongeurs

Almacenaje para pinzas cortantes

Rangement pour rongeurs

Supporto per pinze per afferrare



55-803-20-04

Siebkorb zur Lagerung von Rongeuren

Mesh tray for storage of rongeurs

Bandeja cribada para almacenaje para pinzas cortantes

Panier à maille pour rangement pour rongeurs

Vassoi reticolati per supporto er pinze per afferrare



Beispiel Bestückung

Configuration example

Ejemplo de equipamiento

Exemple d'agencement

Esempio di strumenti



## Zerlegen der Instrumente

Instrument disassembly  
Desmontaje de los instrumentos  
Démontage des instruments  
Smontaggio degli strumenti

## Laminectomiestanzen und Rongeurs

Laminectomy punches and rongeurs  
Pinzas cortantes para laminectomía  
Pincas emporte-pièces à laminectomie et rongeurs  
Pinze taglienti per laminectomia e pinze per afferrare

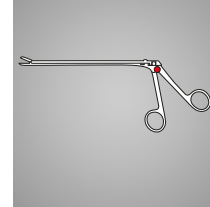

### Anweisung zum Öffnen

1. Griff schließen.
2. Knopf drücken und gedrückt halten.
3. Griff wieder öffnen. Druck auf roten Knopf beibehalten.
4. Das obere Schieberteil ist entriegelt und kann nach links ausgeschwenkt werden.



### Disassembly Instructions

1. Close the handle.
2. Push the button and keep it pushed.
3. Release quickly the front part of the handle.
4. The upper movable shaft is unlocked and can be slid to the left.



### Instrucciones de apertura

1. Cerrar el mango.
2. Presionar el botón y mantenerlo pulsado.
3. Volver a abrir el mango.
4. El vástago superior corredero desengrana y puede girarse hacia la izquierda.



### Consigne d'ouverture

1. Refermez le manche.
2. Appuyez sur le bouton et maintenez-le enfoncé.
3. Rouvrez le manche.
4. La partie supérieure du curseur est débloquée et peut être pivotée vers la gauche.



### Istruzioni per l'apertura

1. Chiudere l'impugnatura.
2. Premere e tenere premuto il pulsante.
3. Riaprire l'impugnatura.
4. La parte superiore scorrevole si sblocca e può essere ruotata a sinistra.

### Hinweis

Durch nochmaliges Schließen des Griffes bleibt der Schaft ausgeschwenkt und das Instrument kann in offenem Zustand sterilisiert werden.

### Advice

If the handle is closed again, the shaft remains swivelled out so that the instrument can be sterilized in open position.

### Nota

Al volver a cerrar el mango de forma normal, el vástago gira y el instrumento puede esterilizarse abierto.

### Remarque

En refermant une nouvelle fois le manche, la tige pivotée reste en position et l'instrument ainsi ouvert peut être stérilisé.

### Nota

Richiudendo l'impugnatura il gambo resta ruotato, in modo da consentire la sterilizzazione dello strumento aperto.

### Zusammensetzen

1. Griff schließen.
2. Knopf drücken und gedrückt halten.
3. Griff öffnen, Schieber einschwenken und nach unten drücken.
4. Griff nochmals schließen – das Instrument ist verriegelt.

### Assembly Instructions

1. Close the handle.
2. Push the button and keep it pushed.
3. Open the handle. Slide back the movable shaft on the instrument and push the shaft downward.
4. Close the handle once again and the instrument is locked.

### Montaje

1. Cerrar el mango.
2. Presionar el botón y mantenerlo pulsado.
3. Abrir el mango, girar el vástago hacia el instrumento y presionar hacia abajo.
4. Volver a cerrar el mango. El instrumento está bloqueado de nuevo.

### Assemblage

1. Fermez le manche.
2. Appuyez sur le bouton et maintenez-le enfoncé.
3. Ouvrez le manche, faites pivoter le curseur et appuyez vers le bas.
4. Rouvrez le manche - l'instrument est verrouillé.

### Rimontaggio

1. Chiudere l'impugnatura.
2. Premere e tenere premuto il pulsante.
3. Aprire l'impugnatura, ritrarre la barra scorrevole e premere verso il basso.
4. Richiudere l'impugnatura – lo strumento è bloccato.



## LubriPen 55-997-01-04

für präzises Ölen von chirurgischen Instrumenten und Medizinprodukten  
for precise lubrication of surgical instruments and medical devices  
para una lubricación perfecta de instrumentos quirúrgicos y dispositivos médicos  
Graissage précis d'instruments chirurgicaux et d'équipements médicaux  
Lubrificazione di precisione di strumenti chirurgici e dispositivi medici

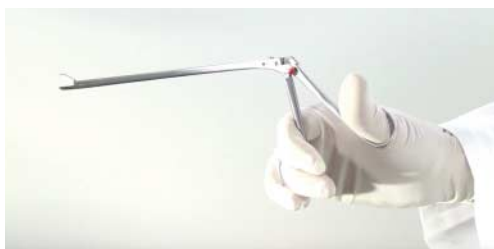

Zerlegen der Instrumente  
Instrument disassembly  
Desmontaje de los instrumentos  
Démontage des instruments  
Smontaggio degli strumenti

[https://www.youtube.com/watch?v=18ul\\_MGOiJ4](https://www.youtube.com/watch?v=18ul_MGOiJ4)



[http://www.youtube.com/watch?v=0tODs7\\_7tYE](http://www.youtube.com/watch?v=0tODs7_7tYE)





Hypophysen- und Schädelbasis-Chirurgie  
Pituitary and skull base surgery  
Cirugía para hipófisis y base del cráneo  
Chirurgie de l'hypophyse et de la base du crâne  
Chirurgia per l'ipofisi e la base cranica

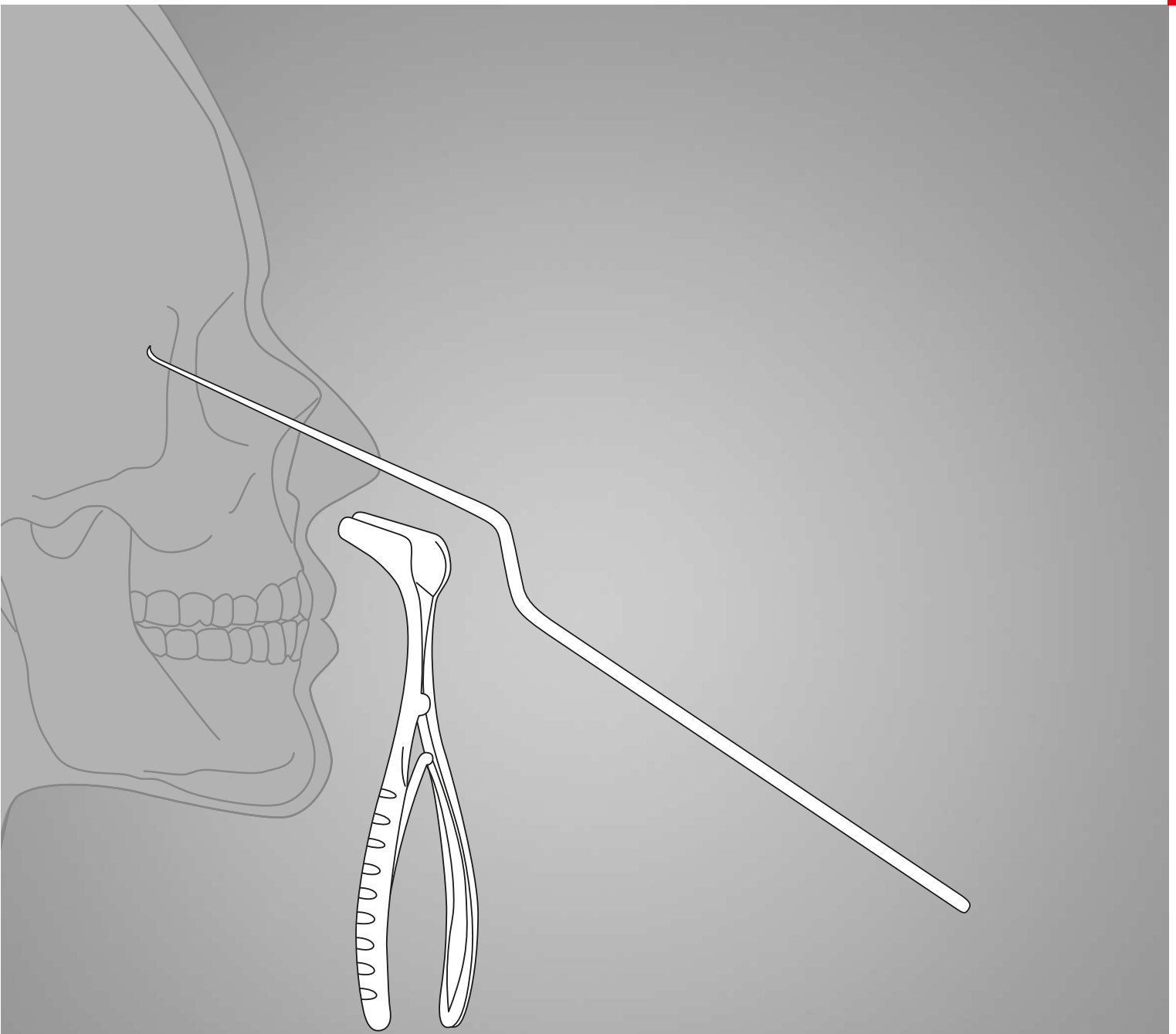

## Mikaeel-Instrumente

Mikaeel instruments  
Instrumentos Mikaeel  
Instruments Mikaeel  
Strumenti Mikaeel

Für mikroskopische Eingriffe  
For microscopic procedures  
Para intervenciones microscópicas  
Pour interventions microscopiques  
Per interventi al microscopio



1/2



1/2

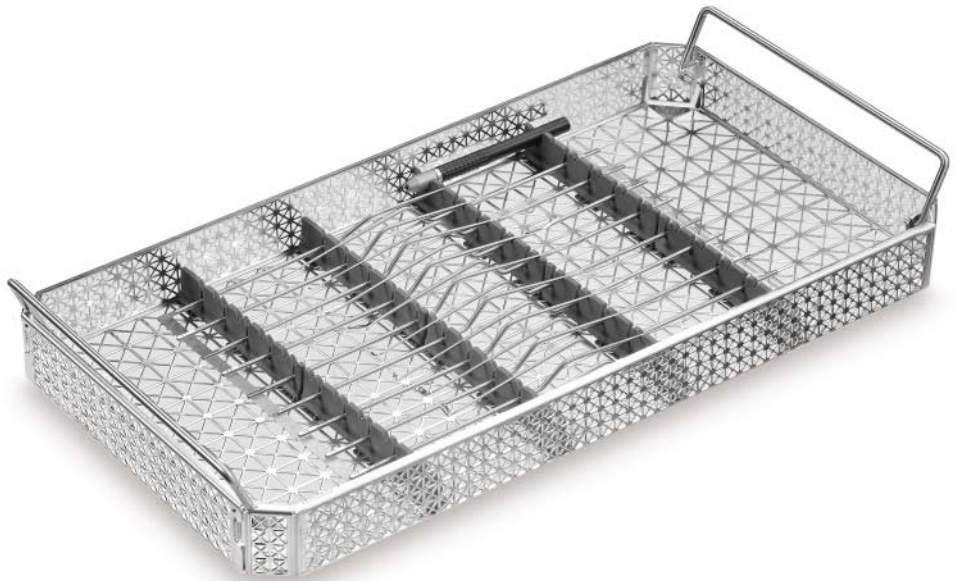

Mikaeel  
24-843-01-07 -  
24-843-18-07

Bajonett  
Bayonet  
Bayoneta  
Baïonnette  
Baionetta

24-849-99-04

Handgriff  
Handle  
Mango  
Manche  
Manico

Mikaeel  
24-843-70-04

Instrumenten-Set, Fig. 1-18, 23 cm, inkl. Siebkorb und 2 Handgriffen  
Instrument set, fig. 1-18, 23 cm, incl. mesh tray and 2 handles  
Juego de instrumentos, fig. 1-18, 23 cm, incl. bandeja cribada y 2 mangos  
Set d'instruments, fig. 1-18, 23 cm, incl. panier à maille et 2 manches  
Set di strumenti, fig. 1-18, 23 cm, compr. vassoio reticolato per supporto e 2 manici

# Mikaeel-Instrumente

Mikaeel instruments  
Instrumentos Mikaeel  
Instruments Mikaeel  
Strumenti Mikaeel

# Hypophysen- und Schädelbasis-Chirurgie

Pituitary and skull base surgery  
Cirugía para hipófisis y base del cráneo  
Chirurgie de l'hypophyse et de la base du crâne  
Chirurgia per l'ipofisi e la base cranica

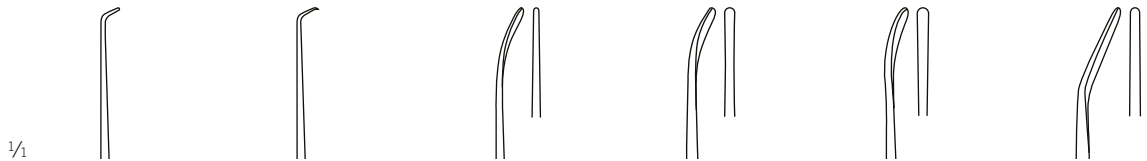
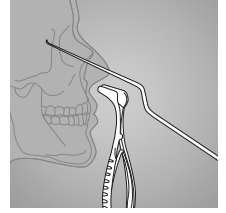

	Fig. 1	Fig. 2	Fig. 3	Fig. 4	Fig. 5	Fig. 6
23 cm, 9"	24-843-01-07	24-843-02-07	24-843-03-07	24-843-04-07	24-843-05-07	24-843-06-07

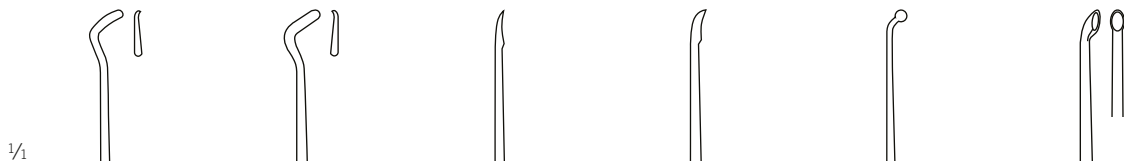

	Fig. 7	Fig. 8	Fig. 9	Fig. 10	Fig. 11	Fig. 12
23 cm, 9"	24-843-07-07	24-843-08-07	24-843-09-07	24-843-10-07	24-843-11-07	24-843-12-07

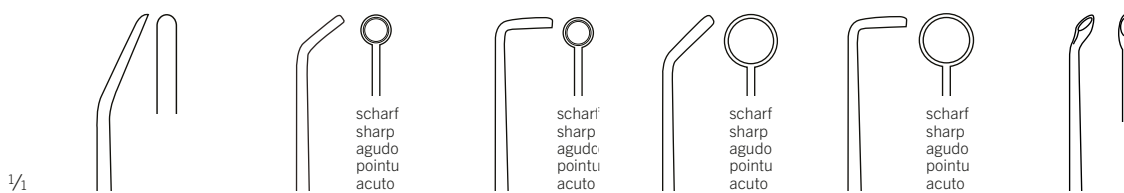

	Fig. 13	Fig. 14	Fig. 15	Fig. 16	Fig. 17	Fig. 18
23 cm, 9"	24-843-13-07	24-843-14-07	24-843-15-07	24-843-16-07	24-843-17-07	24-843-18-07

## Tew-Instrumente

Tew instruments  
Instrumentos Tew  
Instruments Tew  
Strumenti Tew

Für mikroskopische Eingriffe  
For microscopic procedures  
Para intervenciones microscópicas  
Pour interventions microscopiques  
Per interventi al microscopio



1/2



1/2



Tew  
24-844-01-07 -  
24-844-28-07

Bajonett  
Bayonet  
Bayoneta  
Baïonnette  
Baionetta

24-849-99-04

Handgriff  
Handle  
Mango  
Manche  
Manico

Tew  
24-844-70-04

Instrumenten-Set, Fig. 1-28, 23 cm, inkl. Siebkorb und 2 Handgriffen  
Instrument set, fig. 1-28, 23 cm, incl. mesh tray and 2 handles  
Juego de instrumentos, fig. 1-28, 23 cm, incl. bandeja cribada y 2 mangos  
Set d'instruments, fig. 1-28, 23 cm, incl. panier à maille et 2 manches  
Set di strumenti, fig. 1-28, 23 cm, compr. vassoio reticolato per supporto e 2 manici

# Tew-Instrumente

Tew instruments  
Instrumentos Tew  
Instrumenti Tew  
Strumenti Tew

# Hypophysen- und Schädelbasis-Chirurgie

Pituitary and skull base surgery  
Cirugía para hipófisis y base del cráneo  
Chirurgie de l'hypophyse et de la base du crâne  
Chirurgia per l'ipofisi e la base cranica

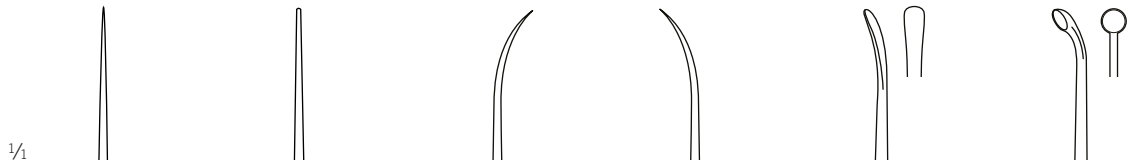
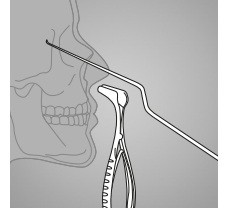

	Fig. 1	Fig. 2	Fig. 3	Fig. 4	Fig. 5	Fig. 6
23 cm, 9"	24-844-01-07	24-844-02-07	24-844-03-07	24-844-04-07	24-844-05-07	24-844-06-07

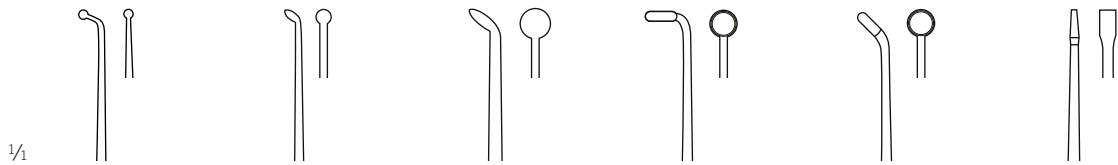

	Fig. 7	Fig. 8	Fig. 9	Fig. 10	Fig. 11	Fig. 12
23 cm, 9"	24-844-07-07	24-844-08-07	24-844-09-07	24-844-10-07	24-844-11-07	24-844-12-07

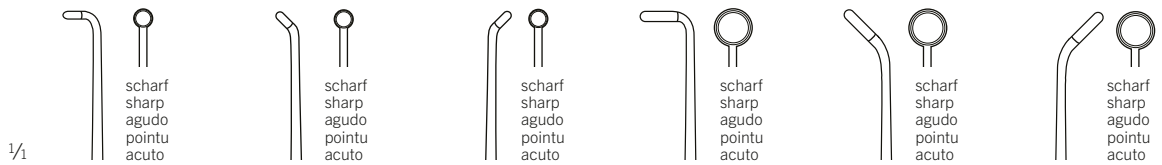

	Fig. 13	Fig. 14	Fig. 15	Fig. 16	Fig. 17	Fig. 18
23 cm, 9"	24-844-13-07	24-844-14-07	24-844-15-07	24-844-16-07	24-844-17-07	24-844-18-07

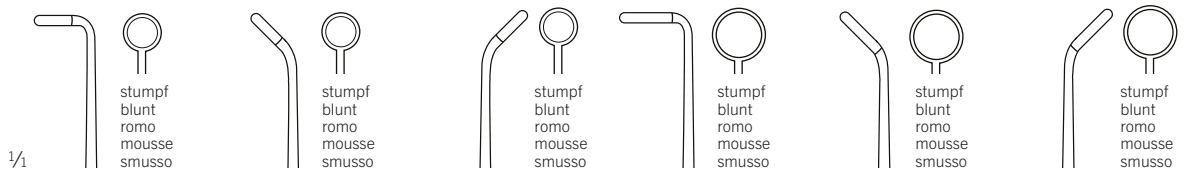

	Fig. 19	Fig. 20	Fig. 21	Fig. 22	Fig. 23	Fig. 24
23 cm, 9"	24-844-19-07	24-844-20-07	24-844-21-07	24-844-22-07	24-844-23-07	24-844-24-07

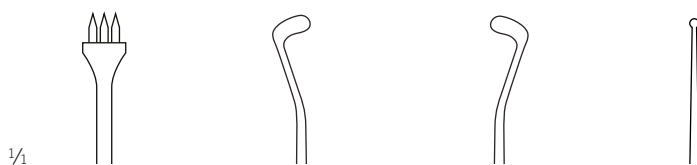
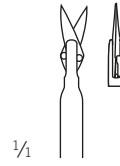

	Fig. 25	Fig. 26	Fig. 27	Fig. 28
23 cm, 9"	24-844-25-07	24-844-26-07	24-844-27-07	24-844-28-07

## Tew-Mikro-Instrumente

Tew micro instruments  
 Micro-instrumentos Tew  
 Micro-instruments Tew  
 Micro-strumenti Tew



1/1

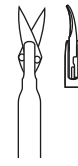

		Schere, gerade, 2,5 mm Scissors, straight, 2.5 mm Tijeras, recta, 2,5 mm Ciseaux, droite, 2,5 mm Forbici, diritta, 2,5 mm	Schere, gebogen, 2,5 mm Scissors, curved, 2.5 mm Tijeras, curvada, 2,5 mm Ciseaux, courbe, 2,5 mm Forbici, curva, 2,5 mm
<b>30 cm / 11 6/8"</b>		24-844-80-07	24-844-81-07
	<b>360°</b>	24-844-84-07	24-844-85-07



1/1



		Biopsie-Zange Biopsy forceps Pinza de biopsia Forceps de biopsie Pinza per biopsia	Alligator-Zange Alligator forceps Pinza Alligator Forceps Alligator Pinza Alligator
<b>30 cm / 11 6/8"</b>		24-844-82-07	24-844-83-07
	<b>360°</b>	24-844-86-07	24-844-87-07



1/2

Tew  
 24-844-80-07 -  
 24-844-83-07

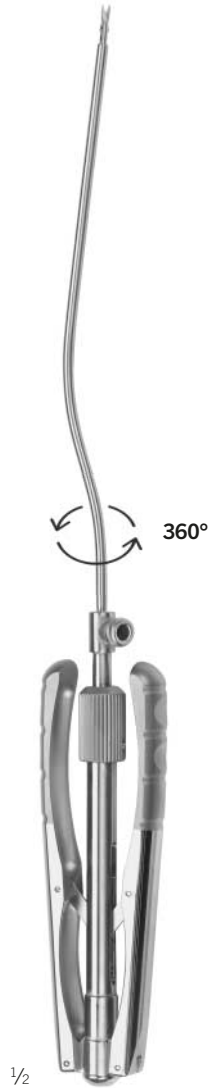

1/2

Tew  
 24-844-84-07 -  
 24-844-87-07



## Pittsburgh-Instrumente

Pittsburgh instruments  
Instrumentos Pittsburgh  
Instruments Pittsburgh  
Strumenti Pittsburgh

## Hypophysen- und Schädelbasis-Chirurgie

Pituitary and skull base surgery  
Cirugía para hipófisis y base del cráneo  
Chirurgie de l'hypophyse et de la base du crâne  
Chirurgia per l'ipofisi e la base cranica

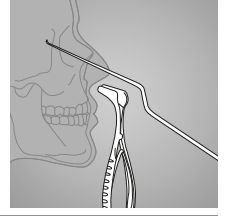

Für endoskopische Eingriffe  
For endoscopic procedures  
Para intervenciones endoscópicas  
Pour interventions endoscopiques  
Per interventi in endoscopia

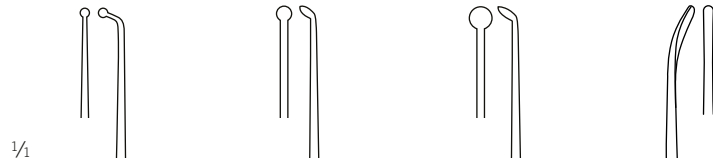

	Fig. 1	Fig. 2	Fig. 3	Fig. 4
23 cm, 9"	 24-849-01-04	24-849-02-04	24-849-03-04	24-849-04-04

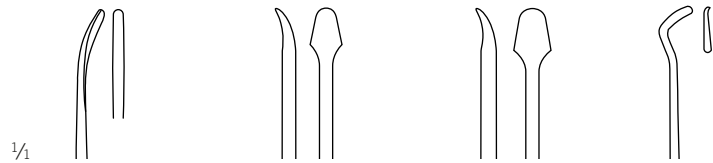

	Fig. 5	Fig. 6	Fig. 7	Fig. 8
23 cm, 9"	 24-849-05-04	24-849-06-04	24-849-07-04	24-849-08-04

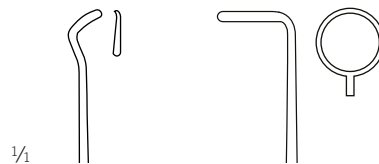



	Fig. 9	Fig. 10
23 cm, 9"	 24-849-09-04	24-849-10-04



Pittsburgh  
24-849-01-04 -  
24-849-10-04

gerade  
straight  
recto  
droit  
diritto

24-849-99-04

Handgriff  
Handle  
Mango  
Manche  
Manico

Pittsburgh  
24-849-00-04

Instrumenten-Set, Fig. 1-10, inkl. Siebkorb und 1 Handgriff  
Instrument set, fig. 1-10, incl. mesh tray and 1 handle  
Juego de instrumentos, fig. 1-10, incl. bandeja cribada y 1 mango  
Set d'instruments, fig. 1-10, incl. panier à maille et 1 manche  
Set di strumenti, fig. 1-10, compr. vassoio reticolato per supporto e 1 manico

## Jannetta-Instrumente

Jannetta instruments  
Instrumentos Jannetta  
Instruments Jannetta  
Strumenti Jannetta

### Dissektionsset für Schädelbasis-Chirurgie

Dissection set for pituitary and skull base surgery

Juego de disección para cirugía de la base del cráneo

Set de dissection pour chirurgie de la base du crâne

Set di dissezione per chirurgia per la base cranica

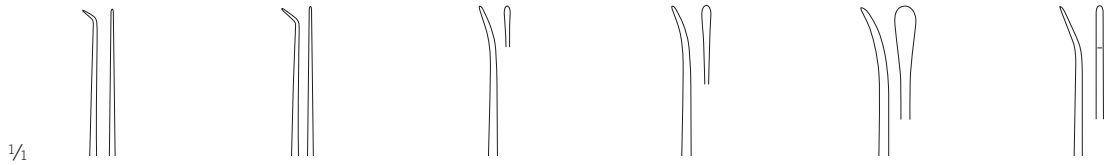

	Fig. 1	Fig. 2	Fig. 3	Fig. 4	Fig. 5	Fig. 6
23 cm, 9"	24-848-01-07	24-848-02-07	24-848-03-07	24-848-04-07	24-848-05-07	24-848-06-07

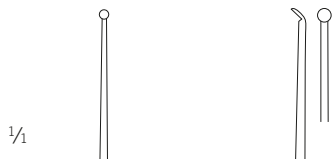

	Fig. 7	Fig. 8
23 cm, 9"	24-848-07-07	24-848-08-07



Jannetta  
24-848-01-07 -  
24-848-08-07



Jannetta  
24-848-00-04

Instrumenten-Set, Fig. 1-8, inkl. Siebkorb  
Instrument set, fig. 1-8, incl. mesh tray  
Juego de instrumentos, fig. 1-8, incl. bandeja  
Set d'instruments, fig. 1-8, incl. panier à maille  
Set di strumenti, fig. 1-8, compr. vassoio reticolato

## Hypophysenzangen

Pituitary forceps

Pinza para hipófisis

Pince pour hypophyse

Pinze per ipofisi

## Hypophysen- und Schädelbasis-Chirurgie

Pituitary and skull base surgery

Cirugía para hipófisis y base del cráneo

Chirurgie de l'hypophyse et de la base du crâne

Chirurgia per l'ipofisi e la base cranica

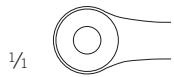
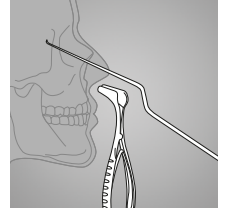

1/4

Landolt

24-855-10-07

20 cm / 7 7/8"

Tumorfasszange

Tumour grasping forceps

Pinzas para sacar tumores

Pince pour saisir des tumeurs

Pinza per afferrare tumori

1/2

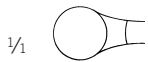
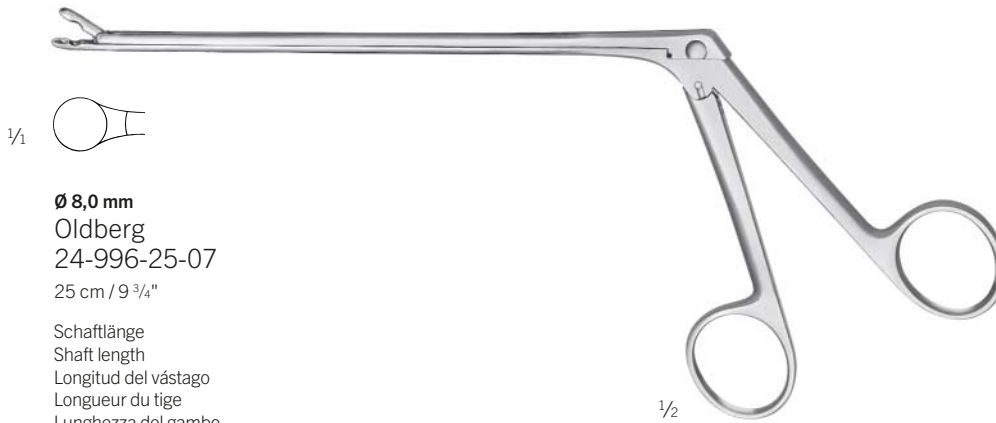

1/4

Ø 8,0 mm

Oldberg

24-996-25-07

25 cm / 9 3/4"

Schaftlänge

Shaft length

Longitud del vástago

Longueur du tige

Lunghezza del gambo

**180 mm**

1/2

## Hypophysenzangen

Pituitary forceps

Pinza para hipófisis

Pince pour hypophyse

Pinze per ipofisi

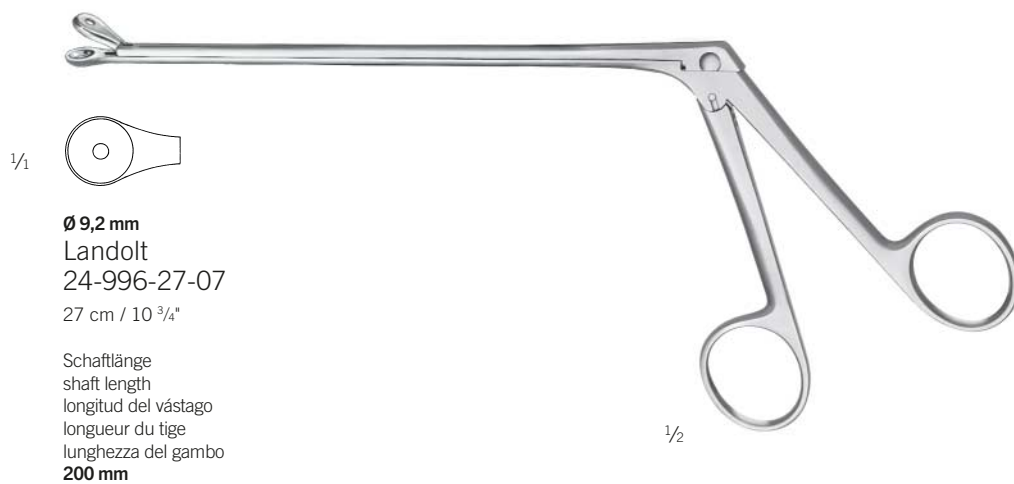

## Hypophysen-Spekula

Pituitary specula

Espéculos para hipófisis

Spéculums pour hypophyse

Specoli per ipofisi

## Hypophysen- und Schädelbasis-Chirurgie

Pituitary and skull base surgery

Cirugía para hipófisis y base del cráneo

Chirurgie de l'hypophyse et de la base du crâne

Chirurgia per l'ipofisi e la base cranica

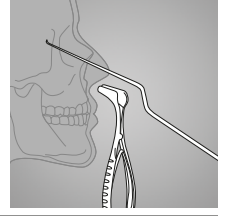

Spreizweite  
Spreading  
Extensión  
Écartement  
Apertura

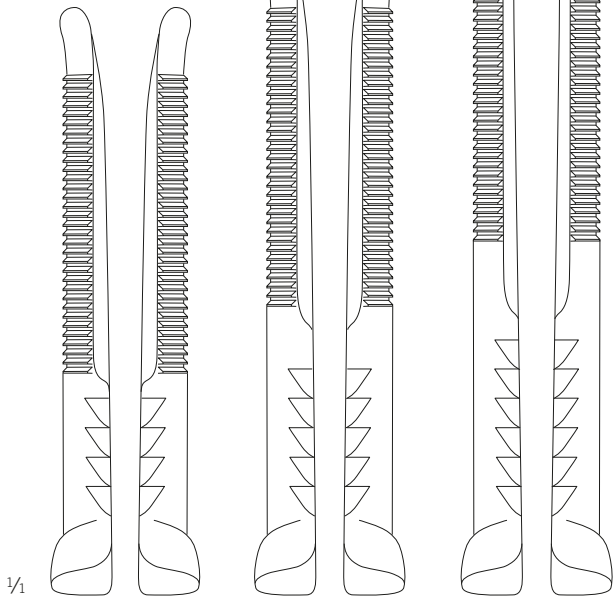

24-998-08-07  
80 x 13 mm



24-998-09-07  
90 x 13 mm



24-998-10-07  
100 x 15 mm

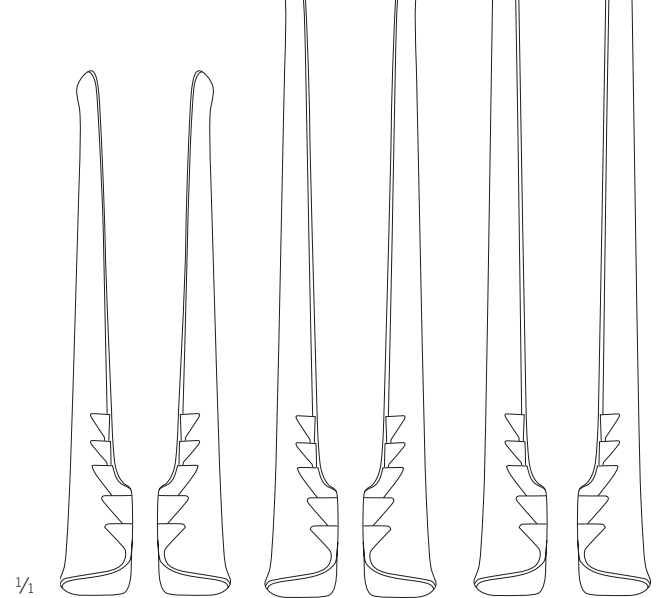

24-999-07-07  
70 x 15 mm



24-999-09-07  
90 x 15 mm



24-999-11-07  
110 x 15 mm



Papavero-Caspar  
24-998-08-07 - 24-998-10-07

inklusive Handgriff  
incl. handle  
incl. mango  
manche compris  
compreso manico



Cushing-Landolt  
24-999-07-07 - 24-999-11-07

## Nasenspekula

Nasal Specula

Espéculos nasales

Spéculums nasaux

Specoli nasali

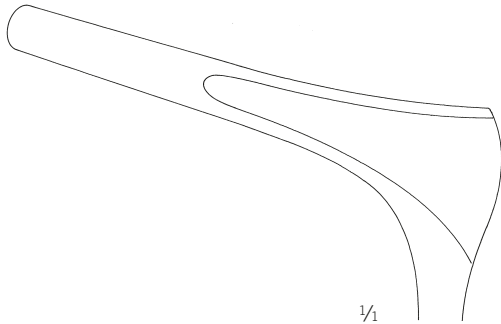

1/1

36-859-75-07

16 cm / 6 <sup>2</sup>/<sub>8</sub>"

Blätter

Blades

Hojas

Lames

Lame

**75 mm**

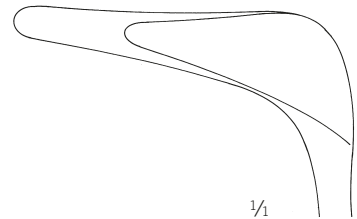

1/1

36-861-45-07

14 cm / 5 <sup>4</sup>/<sub>8</sub>"

Blätter

Blades

Hojas

Lames

Lame

**45 mm**

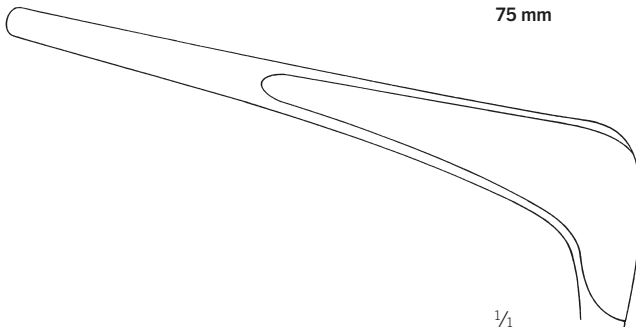

1/1

36-859-90-07

16 cm / 6 <sup>2</sup>/<sub>8</sub>"

Blätter

Blades

Hojas

Lames

Lame

**85 mm**

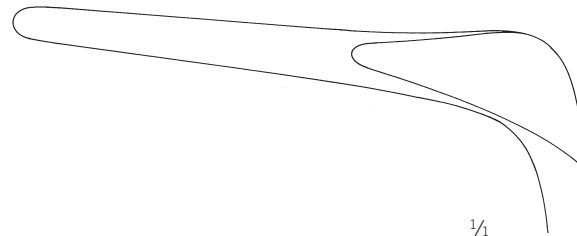

1/1

36-861-75-07

15,5 cm / 6 <sup>1</sup>/<sub>8</sub>"

Blätter

Blades

Hojas

Lames

Lame

**75 mm**



1/2

Cottle

36-859-75-07 - 36-859-90-07



1/2

Cottle

36-861-45-07 - 36-861-75-07

Mikro-Instrumente  
Micro instruments  
Micro-instrumentos  
Micro-instruments  
Micro-strumenti

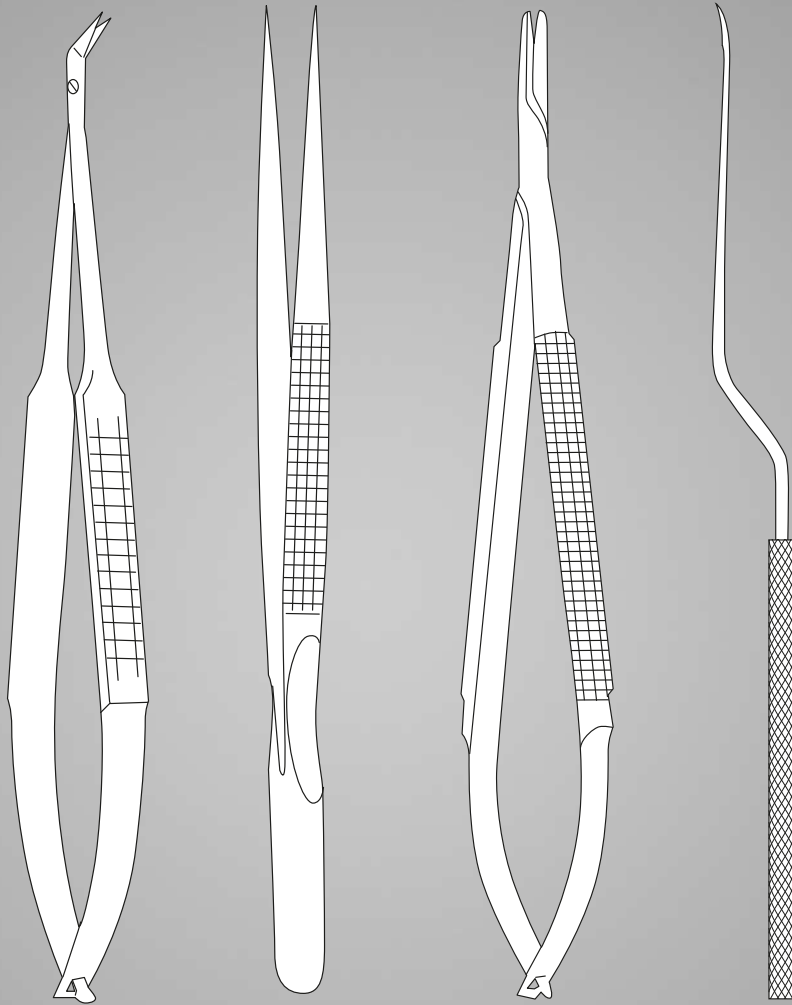





Mikro-Scheren  
Micro Scissors  
Micro-Tijeras  
Micro-Ciseaux  
Micro-Forbici

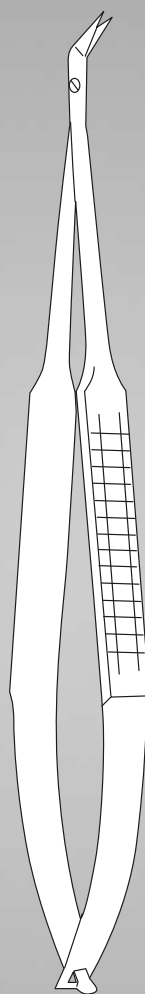

## Kurze Mikro-Scheren

Short Micro Scissors

Micro-Tijeras, corto

Micro-Ciseaux, court





Micro-Forbici, corto



1/2

11-370-01-07 -  
11-371-04-07  
12 cm / 4 9/8"







 12 cm / 4 9/8"		<b>A</b> spitz/spitz sharp/sharp agudo/agudo pointu/pointu appuntato/appuntato	<b>A</b> spitz/spitz sharp/sharp agudo/agudo pointu/pointu appuntato/appuntato	spitz/stumpf sharp/blunt agudo/romo pointu/mousse appuntato/smusso	<b>D</b> stumpf/stumpf blunt/blunt romo/romo mousse/mousse smusso/smusso	mit Knopf with button con botón avec bouton con bottone
		<b>7 mm</b>	<b>7 mm</b>	<b>7 mm</b>	<b>7 mm</b>	<b>7 mm</b>
	11-370-01-07	11-371-01-07	11-371-02-07	11-371-03-07	11-371-04-07	



1/2

11-370-02-07 -  
11-371-08-07  
12 cm / 4 9/8"



 12 cm / 4 9/8"		<b>A</b> spitz/spitz sharp/sharp agudo/agudo pointu/pointu appuntato/appuntato	<b>A</b> spitz/spitz sharp/sharp agudo/agudo pointu/pointu appuntato/appuntato	spitz/stumpf sharp/blunt agudo/romo pointu/mousse appuntato/smusso	<b>D</b> stumpf/stumpf blunt/blunt romo/romo mousse/mousse smusso/smusso	mit Knopf with button con botón avec bouton con bottone
		<b>7 mm</b>	<b>7 mm</b>	<b>7 mm</b>	<b>7 mm</b>	<b>7 mm</b>
	11-370-02-07	11-371-05-07	11-371-06-07	11-371-07-07	11-371-08-07	

A = Adventitia  
D = Präparation  
A-SB = Adventitia, ein gezahntes Blatt  
D-SB = Präparation, ein gezahntes Blatt

A = Adventitia  
D = Dissection  
A-SB = Adventitia, one serrated blade  
D-SB = Dissection, one serrated blade

A = Adventicia  
D = Disección  
A-SB = Adventicia, una hoja dentada  
D-SB = Disección, una hoja dentada

A = Advantice  
D = Dissection  
A-SB = Advantice, une lame dentelée  
D-SB = Dissection, une lame dentelée

A = Avventizia  
D = Dissezione  
A-SB = Avventizia, una lama dentata  
D-SB = Dissezione, una lama dentata

## Mikro-Scheren

Micro Scissors  
Micro-Tijeras  
Micro-Ciseaux  
Micro-Forbici

## Mikro-Scheren

Micro Scissors  
Micro-Tijeras  
Micro-Ciseaux  
Micro-Forbici



1/2

11-384-25-07 -  
11-401-00-07



1/1

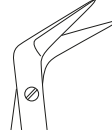
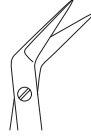

		25°	45°	60°	90°	125°
		<b>10 mm</b>	<b>10 mm</b>	<b>10 mm</b>	<b>10 mm</b>	<b>10 mm</b>
<b>18 cm / 7 1/8"</b>		11-400-25-07	11-400-45-07	11-400-60-07	11-400-90-07	11-401-00-07
<b>21 cm / 8 2/8"</b>		11-384-25-07	11-384-45-07	11-384-60-07	11-384-90-07	11-385-00-07



1/2

11-412-25-07 -  
11-437-00-07



1/1

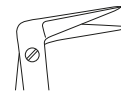
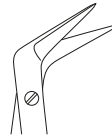
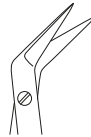

		25°	45°	60°	90°	125°
		<b>10 mm</b>	<b>10 mm</b>	<b>10 mm</b>	<b>10 mm</b>	<b>10 mm</b>
<b>18 cm / 7 1/8"</b>		11-412-25-07	11-412-45-07	11-412-60-07	11-412-90-07	11-413-00-07
<b>21 cm / 8 2/8"</b>		11-436-25-07	11-436-45-07	11-436-60-07	11-436-90-07	11-437-00-07

## Mikro-Scheren

Micro Scissors

Micro-Tijeras

Micro-Ciseaux

Micro-Forbici



1/1

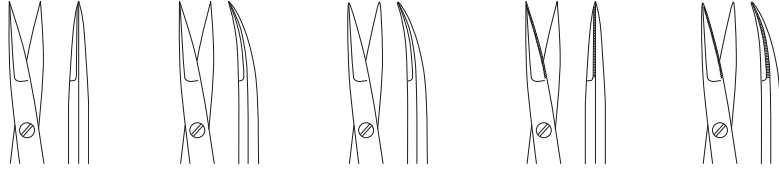

		A	A	D	A-SB	D-SB
		10 mm	10 mm	10 mm	10 mm	10 mm
15 cm / 7 1/8"	St	11-710-15-07	11-711-15-07			
18 cm / 7 1/8"	St	11-710-18-07	11-711-18-07	11-711-19-07	11-710-19-07	11-711-20-07

1/2

11-710-15-07 -  
11-711-20-07



1/1

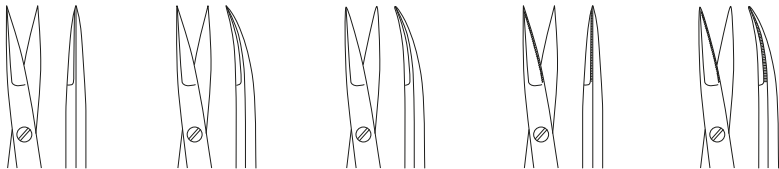

		A	A	D	A-SB	D-SB
		10 mm	10 mm	10 mm	10 mm	10 mm
15 cm / 7 1/8"	St	11-712-15-07	11-713-15-07			
18 cm / 7 1/8"	St	11-712-18-07	11-713-18-07	11-713-19-07	11-712-19-07	11-713-20-07

1/2

11-712-15-07 -  
11-713-20-07

A = Adventitia  
D = Präparation  
A-SB = Adventitia, ein gezahntes Blatt  
D-SB = Präparation, ein gezahntes Blatt

A = Adventitia  
D = Dissection  
A-SB = Adventitia, one serrated blade  
D-SB = Dissection, one serrated blade

A = Adventicia  
D = Disección  
A-SB = Adventicia, una hoja dentada  
D-SB = Disección, una hoja dentada

A = Advantice  
D = Dissection  
A-SB = Advantice, une lame dentelée  
D-SB = Dissection, une lame dentelée

A = Awventizia  
D = Dissezione  
A-SB = Awventizia, una lama dentata  
D-SB = Dissezione, una lama dentata

## Mikro-Scheren, Mikro-Präparierscheren

Micro Scissors, Micro Dissecting Scissors  
Micro-Tijeras, Micro-Tijeras de disección  
Micro-Ciseaux, Micro-Ciseaux à dissection  
Micro-Forbici, Micro-Forbici per dissezione

## Mikro-Scheren

Micro Scissors  
Micro-Tijeras  
Micro-Ciseaux  
Micro-Forbici

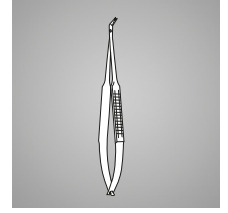

1/2

Biemer

11-758-12-07

12 cm / 4 5/8"

Mikro-Venenschere  
Micro scissors for veins  
Micro-tijeras para venas  
Micro-ciseaux pour les veines  
Micro-forbici per vene

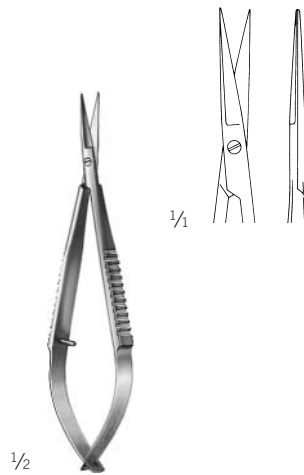

1/2

11-760-09-07

10 cm / 3 7/8"

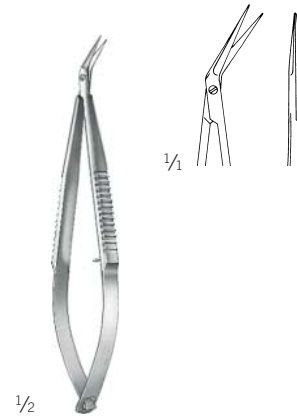

1/2

11-761-09-07

9,5 cm / 3 5/8"



1/2

Vannas

24-850-01-07 - 24-850-03-07

12 cm / 4 5/8"

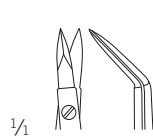

24-850-01-07

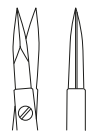

24-850-02-07

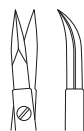

24-850-03-07

## Mikro-Scheren

Micro Scissors

Micro-Tijeras

Micro-Ciseaux

Micro-Forbici

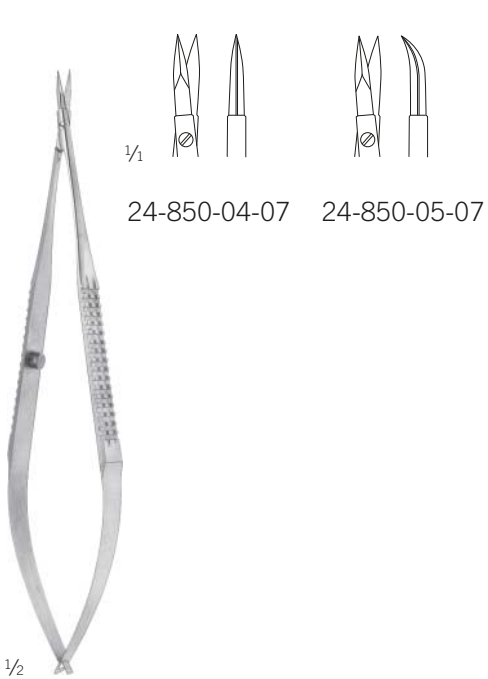

Vannas  
24-850-04-07 - 24-850-05-07  
16 cm / 6 2/8"



Millesi  
24-850-10-07 - 24-850-11-07  
16 cm / 6 2/8"



Jacobson  
24-850-15-07  
18,5 cm / 7 2/8"

## Mikro-Scheren

Micro Scissors  
Micro-Tijeras  
Micro-Ciseaux  
Micro-Forbici

## Mikro-Scheren

Micro Scissors  
Micro-Tijeras  
Micro-Ciseaux  
Micro-Forbici



1/2

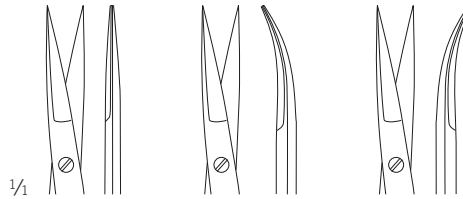

<b>16,5 cm / 6 4/8"</b>	St	24-850-20-07	24-850-21-07	
<b>20 cm / 7 7/8"</b>	St	24-850-22-07	24-850-23-07	24-850-24-07

Yasargil

24-850-20-07 - 24-850-24-07



1/2

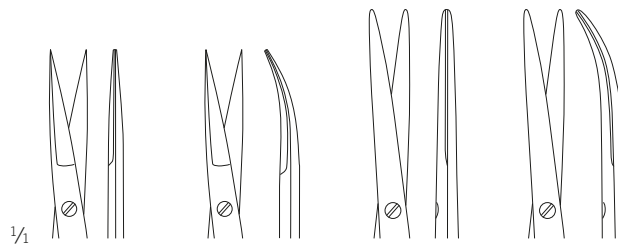

		A	A	D	D
		15 mm	15 mm	15 mm	15 mm
<b>20 cm / 7 7/8"</b>	St			24-850-30-07	24-850-31-07
<b>22,5 cm / 8 7/8"</b>	St	24-850-25-07	24-850-26-07	24-850-33-07	24-850-32-07
<b>24,5 cm / 6 9/8"</b>	St		24-850-28-07		

Yasargil

24-850-25-07 - 24-850-33-07



## Mikro-Scheren

Micro Scissors

Micro-Tijeras

Micro-Ciseaux

Micro-Forbici

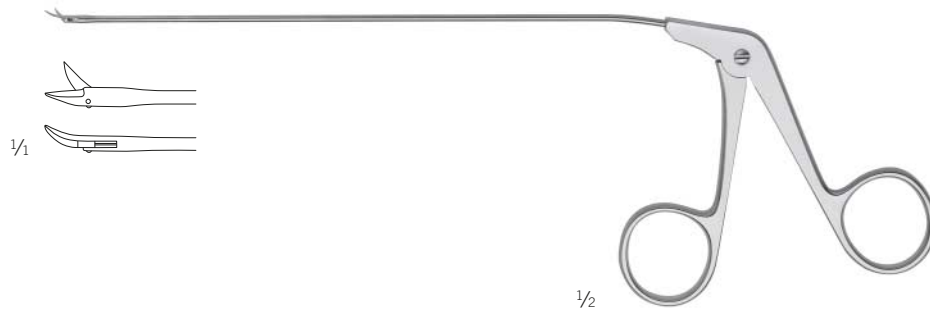

Fahlbusch  
24-850-50-07  
16,5 cm / 6  $\frac{4}{8}$ "

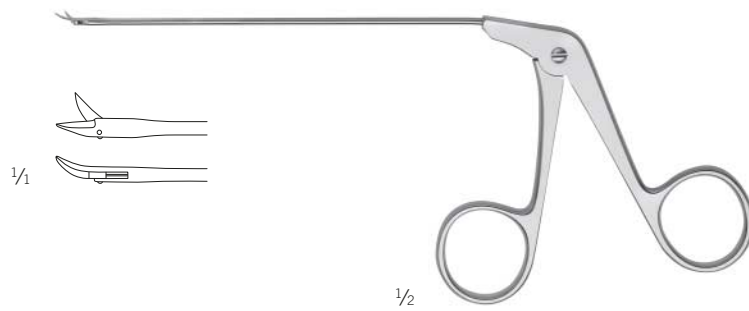

Caspar  
24-850-60-07  
11,5 cm / 4  $\frac{4}{8}$ "

---

Mikro-Pinzetten  
Micro Forceps  
Micro-Pinzas  
Micro-Pinces  
Micro-Pinze

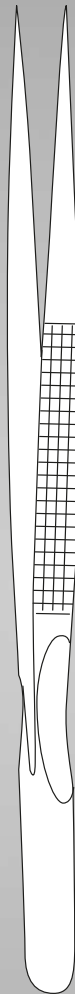

## Kurze Mikro-Pinzetten

Short Micro Forceps

Micro Pinzas, corto

Micro-Pinces, court

Micro-Pinze, corto



1/2

12-552-01-07 -  
12-553-06-07

11 cm / 4 3/8"

1/1

Ø	0.15 mm	0.20 mm	0.30 mm
St	12-552-01-07	12-552-02-07	12-552-03-07

1/1

Ø	0.50 mm	1.2 mm	
St	12-553-01-07	12-553-05-07	12-553-06-07

1/1

	VD	VD	VD
Ø	0.10 mm	0.20 mm	0.30 mm
gewinkelt/angled/ acodada/angulée/ angolata	10°	10°	10°
St	12-552-04-07	12-552-05-07	12-552-06-07



1/2

12-552-07-07 -  
12-553-09-07

11 cm / 4 3/8"

1/1

Ø	0.15 mm	0.20 mm	0.30 mm
St	12-552-07-07	12-552-08-07	12-552-09-07

1/1

Ø	0.50 mm	1.2 mm	
St	12-553-07-07	12-553-08-07	12-553-09-07

1/1

	VD	VD	VD
Ø	0.10 mm	0.20 mm	0.30 mm
gewinkelt/angled/ acodada/angulée/ angolata	10°	10°	10°
St	12-552-10-07	12-552-11-07	12-552-12-07

## Mikro-Pinzetten

Micro Forceps  
Micro-Pinzas  
Micro-Pinces  
Micro-Pinze

## Mikro-Pinzetten

Micro Forceps  
Micro-Pinzas  
Micro-Pinces  
Micro-Pinze

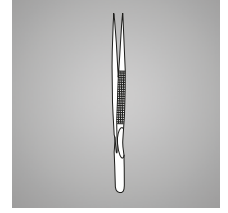

1/2

Jeweler mod.  
12-560-00-07 -  
12-561-45-07

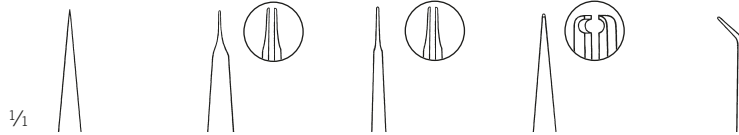

		VD	VD	Pierse	45°
11 cm / 4 3/8"	Ø	0.30 mm	0.20 mm	0.30 mm	0.30 mm
	St	12-560-00-07		12-560-05-07	12-560-45-07
13,5 cm / 5 3/8"	St	12-561-00-07	12-561-02-07	12-561-03-07	12-561-05-07



1/2

Jeweler mod.  
12-560-02-07 -  
12-560-03-07

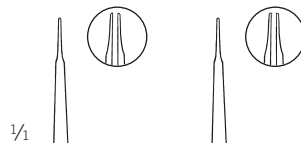

		VD	VD
11 cm / 4 3/8"	Ø	0.20 mm	0.30 mm
	gewinkelt/angled/ acodada/angulée/ angolata	10°	10°
	St	12-560-02-07	12-560-03-07



1/2

12-562-00-07 -  
12-563-05-07



				45°			Pierse
15 cm / 5 7/8"	Ø	0.30 mm	0.30 mm	0.30 mm	R Ø 1.0 x 0.5 mm	VD 0.30 mm	P 0.30 mm
	St	12-562-00-07	12-562-01-07	12-562-02-07	12-562-03-07	12-562-04-07	12-562-05-07
18 cm / 7 1/8"	St	12-563-00-07	12-563-01-07	12-563-02-07	12-563-03-07	12-563-04-07	12-563-05-07

## Mikro-Pinzetten

Micro Forceps

Micro-Pinzas

Micro-Pinces

Micro-Pinze



1/2

12-564-15-07 -  
12-581-21-09



	Ø	0.40 mm	0.40 mm	0.70 mm	0.70 mm	0.80 mm	0.80 mm
<b>15 cm / 5 7/8"</b>	St	12-564-15-07	12-565-15-07	12-566-15-07	12-567-15-07		
<b>15 cm / 5 7/8"</b>	Ti	12-578-15-09	12-579-15-09			12-580-15-09	12-581-15-09
<b>18 cm / 7 1/8"</b>	St	12-564-18-07	12-565-18-07	12-566-18-07	12-567-18-07		
<b>18 cm / 7 1/8"</b>	Ti	12-578-18-09	12-579-18-09			12-580-18-09	12-581-18-09
<b>21 cm / 8 2/8"</b>	St			12-566-21-07	12-567-21-07		
<b>21 cm / 8 2/8"</b>	Ti					12-580-21-09	12-581-21-09

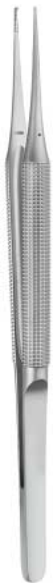

1/2

12-568-15-07 -  
12-583-18-09



	1:2	1:2	1:2	1:2	
Ø	0.40 mm	0.40 mm	0.70 mm	0.70 mm	
<b>15 cm / 5 7/8"</b>	St	12-568-15-07	12-569-15-07	12-570-15-07	12-571-15-07
<b>15 cm / 5 7/8"</b>	Ti	12-582-15-09	12-583-15-09		
<b>18 cm / 7 1/8"</b>	St	12-568-18-07	12-569-18-07	12-570-18-07	12-571-18-07
<b>18 cm / 7 1/8"</b>	Ti	12-582-18-09	12-583-18-09		

## Mikropinzetten, Gefäß-Dilatationspinzetten

Micro Forceps, Micro dilating forceps  
 Micro Pinzas, Micro pinza de dilatación  
 Micro-Pinces, Micro pince à dilater  
 Micro-Pinze, Micro pinze per dilatazione

## Mikro-Pinzetten

Micro Forceps  
 Micro-Pinzas  
 Micro-Pinces  
 Micro-Pinze

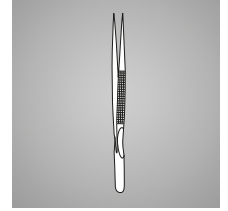

1/2



diamond-coated

1/1



						Atrauma
	Ø	1.0 x 0.5 mm	1.0 x 0.5 mm	2.0 x 1.0 mm	2.0 x 1.0 mm	1.2 mm
15 cm / 5 7/8"	St	12-574-15-07	12-774-15-07	12-576-15-07	12-776-15-07	12-589-15-07
	Ti	12-586-15-09	12-786-15-09	12-588-15-09	12-787-15-09	12-590-15-09
18 cm / 7 1/8"	St	12-574-18-07	12-774-18-07	12-576-18-07	12-776-18-07	12-589-18-07
	Ti	12-586-18-09	12-786-18-09	12-588-18-09	12-787-18-09	12-590-18-09
21 cm / 8 2/8"	St	12-574-21-07	12-774-21-07	12-576-21-07	12-776-21-07	12-589-21-07
	Ti	12-586-21-09	12-786-21-09	12-588-21-09	12-787-21-09	12-590-21-09

12-574-15-07 -  
 12-787-21-09



1/2



diamond-coated

1/1



				45°			Pierse
	Ø	0.30 mm	0.30 mm	0.30 mm	R Ø 1.0 x 0.5 mm	VD* 0.30 mm	P 0.40 mm
15 cm / 5 7/8"	St	12-591-00-07	12-591-01-07	12-591-02-07	12-591-03-07	12-591-04-07	12-591-05-07
18 cm / 7 1/8"	St	12-592-00-07	12-592-01-07	12-592-02-07	12-592-03-07	12-592-04-07	12-592-05-07

\*VD = Gefäßdilator  
 Vascular dilator  
 Dilatador vascular  
 Dilatateur vasculaire  
 Dilatatore vascolare

12-591-00-07 -  
 12-592-05-07

## Mikro-Pinzetten

Micro Forceps

Micro Pinzas

Micro-Pinces

Micro-Pinze

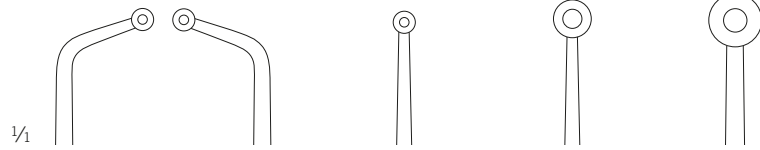

		Samii	Samii	Yasargil-Samii	Yasargil-Samii	Yasargil-Samii
	∅	<b>3.0 mm</b>	<b>3.0 mm</b>	<b>3.0 mm</b>	<b>5.0 mm</b>	<b>7.0 mm</b>
<b>23 cm / 9"</b>		24-852-01-07	24-852-02-07			
<b>24 cm / 9 5/8"</b>				24-852-10-07	24-852-11-07	24-852-12-07

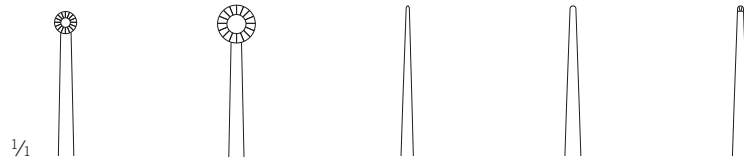

		Yasargil	Yasargil	Yasargil	Yasargil	Yasargil
	∅	<b>3.0 mm</b>	<b>5.0 mm</b>	<b>0.6 mm</b>	<b>0.9 mm</b>	
	mm					<b>1:2</b>
<b>18 cm / 7 1/8"</b>				24-852-70-07	24-852-71-07	24-852-72-07
<b>20 cm / 7 7/8"</b>				24-852-73-07	24-852-74-07	
<b>22 cm / 8 5/8"</b>		24-852-25-07	24-852-26-07	24-852-75-07	24-852-76-07	

1/2

24-852-01-07 -  
24-852-76-07

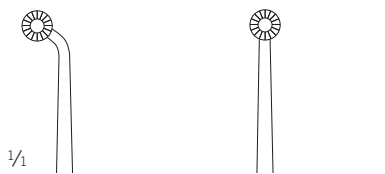

24-852-60-07

**5 mm**  
abgewinkelt  
angled  
acodado  
coudé  
angolato

24-852-61-07

**5 mm**  
bajonett  
bayonet  
bayoneta  
baïonnette  
baionetta

1/2

Hunt  
24-852-60-07 -  
24-852-61-07

---

Mikro-Nadelhalter  
Micro Needle Holders  
Micro-Porta-agujas  
Micro-Porte-aiguilles  
Micro-Portaghi

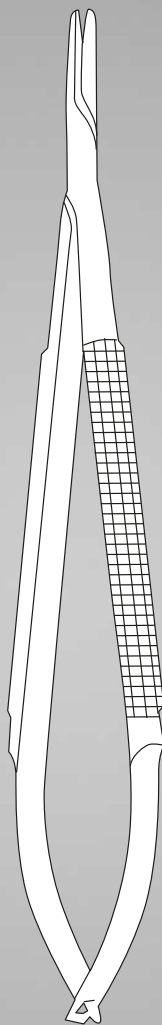



# Mikro-Nadelhalter

Micro Needle Holders

Micro-Porta-agujas

Micro-Porte-aiguilles

Micro-Portaghi



8-0 - 9-0

1/1



1/2

		mit Sperre with lock con trinquete avec cran d'arrêt con arresto	mit Sperre with lock con trinquete avec cran d'arrêt con arresto	ohne Sperre without lock sin trinquete sans cran d'arrêt senza arresto	ohne Sperre without lock sin trinquete sans cran d'arrêt senza arresto
	Ø	<b>0.40 mm</b>	<b>0.40 mm</b>	<b>0.40 mm</b>	<b>0.40 mm</b>
<b>15 cm / 5 7/8"</b>	St	20-002-15-07	20-003-15-07	20-004-15-07	20-005-15-07
	Ti	20-016-15-09	20-017-15-09	20-018-15-09	20-019-15-09
<b>18 cm / 7 1/8"</b>	St	20-002-18-07	20-003-18-07	20-004-18-07	20-005-18-07
	Ti	20-016-18-09	20-017-18-09	20-018-18-09	20-019-18-09

20-002-15-07 -  
20-019-18-09



6-0 - 8-0

1/1



1/2

		mit Sperre with lock con trinquete avec cran d'arrêt con arresto	mit Sperre with lock con trinquete avec cran d'arrêt con arresto	ohne Sperre without lock sin trinquete sans cran d'arrêt senza arresto	ohne Sperre without lock sin trinquete sans cran d'arrêt senza arresto
	Ø	<b>0.80 mm</b>	<b>0.80 mm</b>	<b>0.80 mm</b>	<b>0.80 mm</b>
<b>15 cm / 5 7/8"</b>	St	20-010-15-07	20-011-15-07	20-012-15-07	20-013-15-07
	Ti	20-020-15-09	20-021-15-09	20-022-15-09	20-023-15-09
<b>18 cm / 7 1/8"</b>	St	20-010-18-07	20-011-18-07	20-012-18-07	20-013-18-07
	Ti	20-020-18-09	20-021-18-09	20-022-18-09	20-023-18-09
<b>21 cm / 8 2/8"</b>	St	20-010-21-07	20-011-21-07	20-012-21-07	20-013-21-07
	Ti	20-020-21-09	20-021-21-09	20-022-21-09	20-023-21-09
<b>23 cm / 9"</b>	St	20-010-23-07	20-011-23-07	20-012-23-07	20-013-23-07
	Ti	20-020-23-09	20-021-23-09	20-022-23-09	20-023-23-09

20-010-15-07 -  
20-023-23-09

## Mikro-Nadelhalter

Micro Needle Holders  
Micro-Porta-agujas  
Micro-Porte-aiguilles  
Micro-Portaghi

## Mikro-Nadelhalter

Micro Needle Holders  
Micro-Porta-agujas  
Micro-Porte-aiguilles  
Micro-Portaghi



1/1



1/2

20-030-15-07 -  
20-033-23-09

		mit Sperre with lock con trinquete avec cran d'arrêt con arresto	mit Sperre with lock con trinquete avec cran d'arrêt con arresto	ohne Sperre without lock sin trinquete sans cran d'arrêt senza arresto	ohne Sperre without lock sin trinquete sans cran d'arrêt senza arresto
	Ø	1.2 mm	1.2 mm	1.2 mm	1.2 mm
15 cm / 5 7/8"	St	20-030-15-07	20-031-15-07	20-032-15-07	20-033-15-07
	Ti	20-030-15-09	20-031-15-09	20-032-15-09	20-033-15-09
18 cm / 7 1/8"	St	20-030-18-07	20-031-18-07	20-032-18-07	20-033-18-07
	Ti	20-030-18-09	20-031-18-09	20-032-18-09	20-033-18-09
21 cm / 8 2/8"	St	20-030-21-07	20-031-21-07	20-032-21-07	20-033-21-07
	Ti	20-030-21-09	20-031-21-09	20-032-21-09	20-033-21-09
23 cm / 9"	St	20-030-23-07	20-031-23-07	20-032-23-07	20-033-23-07
	Ti	20-030-23-09	20-031-23-09	20-032-23-09	20-033-23-09



1/2

20-048-18-07 -  
20-051-18-07  
18 cm / 7 1/8"

1/1



		mit Sperre with lock con trinquete avec cran d'arrêt con arresto	mit Sperre with lock con trinquete avec cran d'arrêt con arresto	ohne Sperre without lock sin trinquete sans cran d'arrêt senza arresto	ohne Sperre without lock sin trinquete sans cran d'arrêt senza arresto
18 cm / 7 1/8"	St	20-048-18-07	20-049-18-07	20-050-18-07	20-051-18-07

## Mikro-Nadelhalter

Micro Needle Holders

Micro-Porta-agujas

Micro-Porte-aiguilles

Micro-Portaghi



1/2



20-298-10-07  
10,5 cm / 4 1/8"



20-298-11-07  
11,5 cm / 4 4/8"



20-299-10-07  
10,5 cm / 4 1/8"



20-299-11-07  
11,5 cm / 4 4/8"

Barraquer-Troutman  
20-298-10-07 -  
20-299-11-07



1/2

1/1



		ohne Sperre without lock sin trinquete sans cran d'arrêt senza arresto	ohne Sperre without lock sin trinquete sans cran d'arrêt senza arresto	mit Sperre with lock con trinquete avec cran d'arrêt con arresto
<b>11,5 cm / 4 4/8"</b>	St	20-300-11-07		
<b>13,5 cm / 5 3/8"</b>	St		20-300-13-07	20-300-14-07

Barraquer  
20-300-11-07 -  
20-300-14-07

## Mikro-Nadelhalter

Micro Needle Holders  
Micro-Porta-agujas  
Micro-Porte-aiguilles  
Micro-Portaghi

## Mikro-Nadelhalter

Micro Needle Holders  
Micro-Porta-agujas  
Micro-Porte-aiguilles  
Micro-Portaghi



Barraquer  
20-301-13-07

13,5 cm / 5 3/8"

sehr feines Maul  
very delicate jaw  
boca muy delicada  
mors très fin  
morso strafino



Castroviejo-Fino  
20-302-01-07

13 cm / 5 1/8"

sehr feines Maul  
very delicate jaw  
boca muy delicada  
mors très fin  
morso strafino



Castroviejo-Fino  
20-303-01-07

13 cm / 5 1/8"

sehr feines Maul  
very delicate jaw  
boca muy delicada  
mors très fin  
morso strafino



Castroviejo-Fino  
20-303-09-07

9 cm / 3 4/8"



Castroviejo-Fino  
20-304-01-07

13 cm / 5 1/8"

sehr feines Maul, mit Sperre  
very delicate jaw, with lock  
boca muy delicada, con cierre  
mors très fin, avec serrure  
morso strafino, con fermo



Castroviejo-Fino  
20-304-09-07

9 cm / 3 4/8"



Castroviejo-Fino  
20-305-01-07

13 cm / 5 1/8"

sehr feines Maul, mit Sperre  
very delicate jaw, with lock  
boca muy delicada, con cierre  
mors très fin, avec serrure  
morso strafino, con fermo



Castroviejo-Fino  
20-305-09-07

9 cm / 3 4/8"

## Mikro-Nadelhalter

Micro Needle Holders

Micro-Porta-agujas

Micro-Porte-aiguilles

Micro-Portaghi



1/1



20-306-14-07  
14,5 cm / 5 7/8"

20-307-14-07  
14,5 cm / 5 7/8"

1/2

Castroviejo  
20-306-14-07 -  
20-307-14-07



1/1



20-308-14-07  
14,5 cm / 5 7/8"

20-309-14-07  
14,5 cm / 5 7/8"

1/2

Castroviejo  
20-308-14-07 -  
20-309-14-07



1/1



20-310-14-07  
14,5 cm / 5 7/8"

20-311-14-07  
14,5 cm / 5 7/8"

1/2

Castroviejo  
20-310-14-07 -  
20-311-14-07



1/1



1/2

Castroviejo  
20-313-14-07  
14,5 cm / 5 7/8"

## Mikro-Nadelhalter

Micro Needle Holders  
Micro-Porta-agujas  
Micro-Porte-aiguilles  
Micro-Portaghi

## Mikro-Nadelhalter

Micro Needle Holders  
Micro-Porta-agujas  
Micro-Porte-aiguilles  
Micro-Portaghi



**TC GOLD**

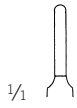

**6-0 - 12-0**  
**Smooth**

Hepp-Scheidel  
20-602-18-07  
18,5 cm / 7 <sup>2</sup>/<sub>8</sub>"

1/2



safety-wave

diamond-coated

**2-0 - 4-0**

1/4



		mit Sperre with lock con trinquete avec cran d'arrêt con arresto	mit Sperre with lock con trinquete avec cran d'arrêt con arresto	ohne Sperre without lock sin trinquete sans cran d'arrêt senza arresto	ohne Sperre without lock sin trinquete sans cran d'arrêt senza arresto
	Ø	2.0 mm	2.0 mm	2.0 mm	2.0 mm
15 cm / 5 <sup>7</sup> / <sub>8</sub> "	St	20-606-15-07	20-605-15-07	20-608-15-07	20-607-15-07
18 cm / 7 <sup>1</sup> / <sub>8</sub> "	St	20-606-18-07	20-605-18-07	20-608-18-07	20-607-18-07
21 cm / 8 <sup>2</sup> / <sub>8</sub> "	St	20-606-21-07	20-605-21-07	20-608-21-07	20-607-21-07
23 cm / 9"	St	20-606-23-07	20-605-23-07	20-608-23-07	20-607-23-07

1/2

20-605-15-07 -  
20-608-23-07

# Mikro-Nadelhalter

Micro Needle Holders

Micro-Porta-agujas

Micro-Porte-aiguilles

Micro-Portaghi



2-0 - 5-0



1/1



5-0 - 8-0



Micro

1/2

Jaboma  
20-610-18-07  
18 cm / 7 1/8"



1/2

1/1



20-613-19-07  
19 cm / 7 4/8"



20-613-23-07  
23 cm / 9"

## Kurze Mikro-Nadelhalter

Short Micro Needle Holders

Micro Porta-agujas, corto

Micro porte-aiguilles, court

Micro Portaghi, corto

## Mikro-Nadelhalter

Micro Needle Holders

Micro-Porta-agujas

Micro-Porte-aiguilles

Micro-Portaghi



1/2



8-0 - 9-0

1/1



	●	mit Sperre with lock con trinquete avec cran d'arrêt con arresto	mit Sperre with lock con trinquete avec cran d'arrêt con arresto	ohne Sperre without lock sin trinquete sans cran d'arrêt senza arresto	ohne Sperre without lock sin trinquete sans cran d'arrêt senza arresto
Ø		0.40 mm	0.40 mm	0.40 mm	0.40 mm
St		20-614-02-07	20-615-01-07	20-614-01-07	20-615-02-07

20-614-01-07 -  
20-615-02-07

14,5 cm / 5 7/8"



1/2



8-0 - 9-0

1/1



	●	mit Sperre with lock con trinquete avec cran d'arrêt con arresto	ohne Sperre without lock sin trinquete sans cran d'arrêt senza arresto	ohne Sperre without lock sin trinquete sans cran d'arrêt senza arresto	mit Sperre with lock con trinquete avec cran d'arrêt con arresto
Ø		0.40 mm	0.40 mm	0.40 mm	0.40 mm
St		20-614-04-07	20-615-04-07	20-614-03-07	20-615-03-07

20-614-03-07 -  
20-615-04-07

14,5 cm / 5 7/8"



## Mikro-Nadelhalter

Micro Needle Holders

Micro-Porta-agujas

Micro-Porte-aiguilles

Micro-Portaghi

## TC GOLD

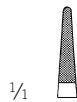

20-620-00-07

14,5 cm / 5 7/8"

Mikroprofil  
micro profile  
perfil micro  
profil micro  
profilo micro



20-620-01-07

14,5 cm / 5 7/8"

Mikroprofil  
micro profile  
perfil micro  
profil micro  
profilo micro



20-620-14-07

14,5 cm / 5 7/8"

glattes Maul  
smooth jaw  
boca lisa  
mors lisse  
morso liscio



20-620-18-07

18 cm / 7 1/8"

Mikroprofil  
micro profile  
perfil micro  
profil micro  
profilo micro



20-620-21-07

22 cm / 8 5/8"

Mikroprofil  
micro profile  
perfil micro  
profil micro  
profilo micro



20-621-14-07

14,5 cm / 5 7/8"

glattes Maul  
smooth jaw  
boca lisa  
mors lisse  
morso liscio



20-621-18-07

18 cm / 7 1/8"

Mikroprofil  
micro profile  
perfil micro  
profil micro  
profilo micro



20-621-21-07

22 cm / 8 5/8"

Mikroprofil  
micro profile  
perfil micro  
profil micro  
profilo micro



1/2

Castroviejo  
20-620-00-07 -  
20-621-21-07

## Mikro-Nadelhalter

Micro Needle Holders  
Micro-Porta-agujas  
Micro-Porte-aiguilles  
Micro-Portaghi

## Mikro-Nadelhalter

Micro Needle Holders  
Micro-Porta-agujas  
Micro-Porte-aiguilles  
Micro-Portaghi



## TC GOLD

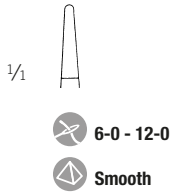

Castroviejo  
20-624-13-07

12,5 cm / 4 7/8"

mit Sperre  
with lock  
con cierre  
avec serrure  
con fermo

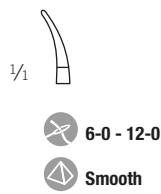

Barraquer  
20-626-13-07

13 cm / 5 1/8"

mit Sperre  
with lock  
con cierre  
avec serrure  
con fermo

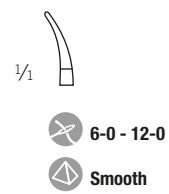

Barraquer  
20-628-13-07

13 cm / 5 1/8"

ohne Sperre  
without lock  
sin trinquete  
sans cran d'arrêt  
senza arresto

## Mikro-Nadelhalter

Micro Needle Holders

Micro-Porta-agujas

Micro-Porte-aiguilles

Micro-Portaghi



1/1



24-851-10-07  
20 cm / 7 7/8"



24-851-11-07  
20 cm / 7 7/8"



24-851-12-07  
22,5 cm / 8 7/8"



24-851-13-07  
22,5 cm / 8 7/8"

1/2

Yasargil  
24-851-10-07 -  
24-851-13-07

Mikro-Instrumente  
Micro instruments  
Micro-instrumentos  
Micro-instruments  
Micro-strumenti

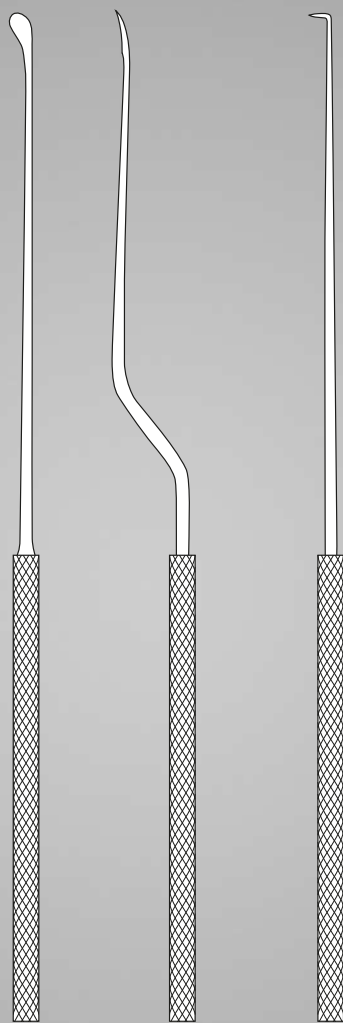

## Mikro-Instrumente

Micro instruments  
Micro-instrumentos  
Micro instruments  
Micro-strumenti

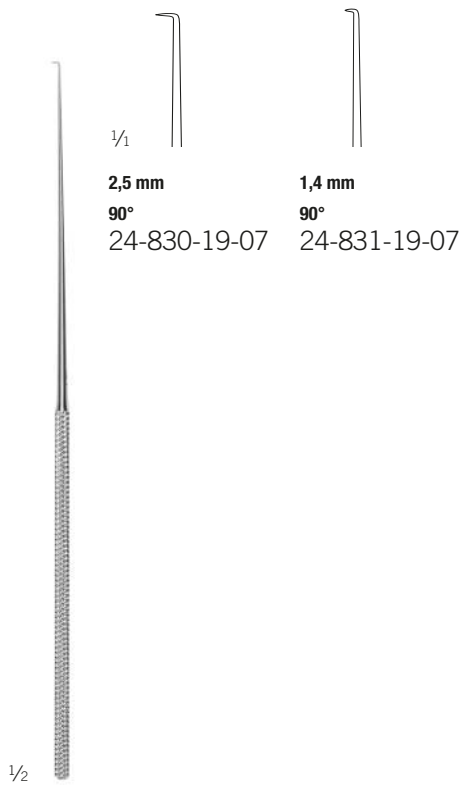

$\frac{1}{1}$   
**2,5 mm**  
**90°**  
24-830-19-07

**1,4 mm**  
**90°**  
24-831-19-07

24-830-19-07 -  
24-831-19-07  
19 cm / 7  $\frac{4}{8}$ "  
Mikro-Häkchen  
Micro hooklet  
Micro-gancho  
Micro-crochet  
Micro-uncino

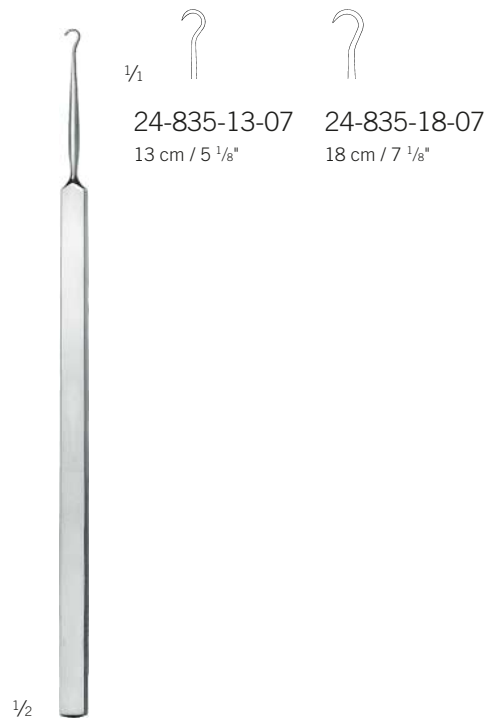

$\frac{1}{1}$   
24-835-13-07  
13 cm / 5  $\frac{1}{8}$ "

24-835-18-07  
18 cm / 7  $\frac{1}{8}$ "

Frazier  
24-835-13-07 -  
24-835-18-07

## Mikro-Instrumente

Micro instruments  
Micro-instrumentos  
Micro instruments  
Micro-strumenti

## Mikro-Instrumente

Micro instruments  
Micro-instrumentos  
Micro instruments  
Micro-strumenti

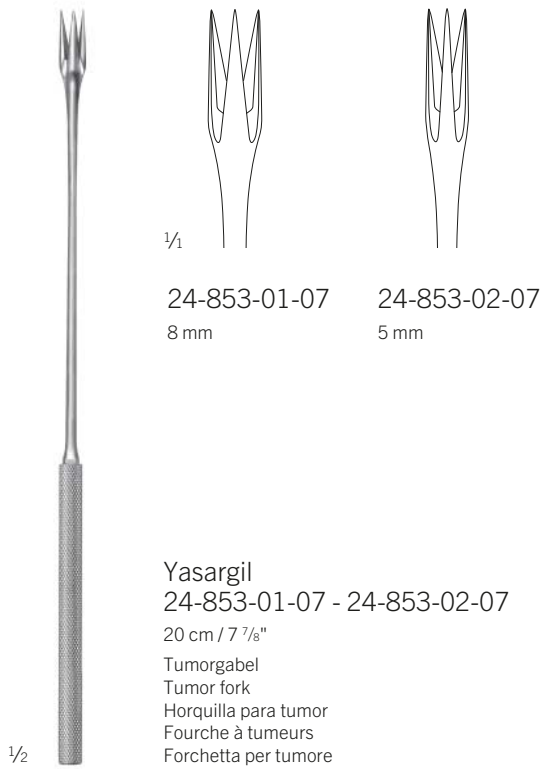

**Yasargil**  
24-853-01-07 - 24-853-02-07  
20 cm / 7 7/8"  
Tumorgabel  
Tumor fork  
Horquilla para tumor  
Fourche à tumeurs  
Forchetta per tumore



**24-853-03-07**  
18,5 cm / 7 3/8"  
Gewebekralle  
Tissue forceps  
Pinza para tejido  
Pince à tissus  
Pinze per tessuto

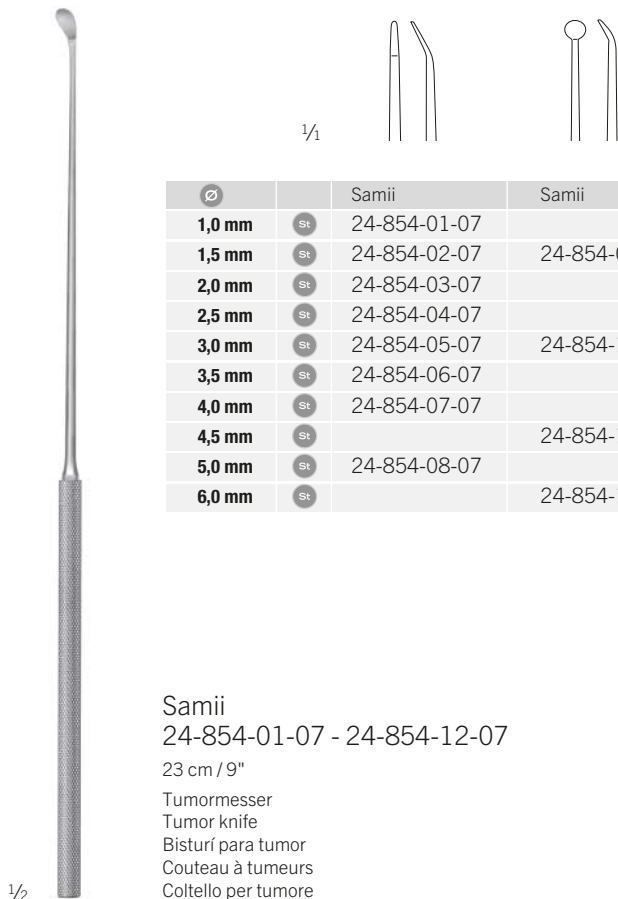

Ø		Samii	Samii
1,0 mm	St	24-854-01-07	
1,5 mm	St	24-854-02-07	24-854-09-07
2,0 mm	St	24-854-03-07	
2,5 mm	St	24-854-04-07	
3,0 mm	St	24-854-05-07	24-854-10-07
3,5 mm	St	24-854-06-07	
4,0 mm	St	24-854-07-07	
4,5 mm	St		24-854-11-07
5,0 mm	St	24-854-08-07	
6,0 mm	St		24-854-12-07

**Samii**  
24-854-01-07 - 24-854-12-07  
23 cm / 9"  
Tumormesser  
Tumor knife  
Bisturí para tumor  
Couteau à tumeurs  
Coltello per tumore

## Mikro-Instrumente

Micro instruments  
Micro-instrumentos  
Micro instruments  
Micro-strumenti

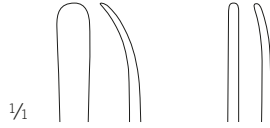

	∅	4,5 mm	1,0 mm
20 cm / 7 7/8"	St		24-856-04-07
23 cm / 9"	St	24-856-01-07	

Caspar  
24-856-01-07 -  
24-856-04-07

Mikro-Dissektor, gerade  
Micro dissector, straight  
Micro-dissector, recto  
Micro-dissecteur, droit  
Micro-dissettore, diritto

1/2

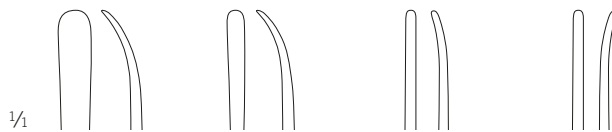

	∅	4,5 mm	2,0 mm	1,0 mm	1,0 mm
20 cm / 7 7/8"	St			24-856-05-07	24-856-06-07
23 cm / 9"	St	24-856-02-07	24-856-03-07		

Caspar  
24-856-02-07 -  
24-856-06-07

Mikro-Dissektor, bajonett  
Micro dissector, bayonet  
Micro-dissector, bayoneta  
Micro-dissecteur, baïonnette  
Micro-dissettore, baionetta

1/2

## Mikro-Instrumente

Micro instruments  
Micro-instrumentos  
Micro instruments  
Micro-strumenti

## Mikro-Instrumente

Micro instruments  
Micro-instrumentos  
Micro instruments  
Micro-strumenti



Samii  
24-858-01-07  
23 cm / 9"  
Lanzettenmesser  
Lancet knife  
Cuchillo de lanceta  
Couteau lancéolaire  
Coltello lanceolato

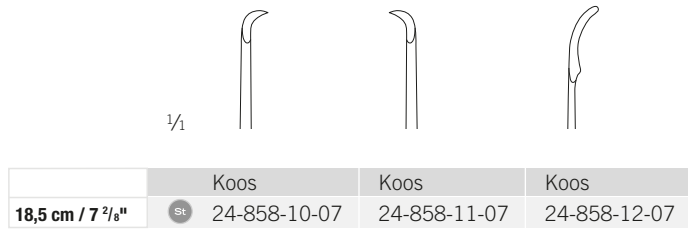

		Koos	Koos	Koos
<b>18,5 cm / 7 2/8"</b>	st	24-858-10-07	24-858-11-07	24-858-12-07

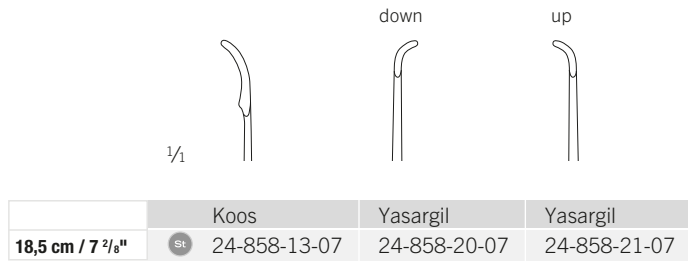

		Koos	Yasargil	Yasargil
<b>18,5 cm / 7 2/8"</b>	st	24-858-13-07	24-858-20-07	24-858-21-07

24-858-10-07 -  
24-858-21-07  
Mikrogefäßmesser, bajonett  
Micro vascular knife, bayoneta  
Micro-cuchillo vascular, bayoneta  
Micro-couteau vasculaire, baïonnette  
Micro-coltello vascolare, baionetta



Jacobson  
24-858-30-07  
18,5 cm / 7 2/8"  
Mikrogefäßmesser  
Micro vascular knife  
Micro-cuchillo vascular  
Micro-couteau vasculaire  
Micro-coltello vascolare

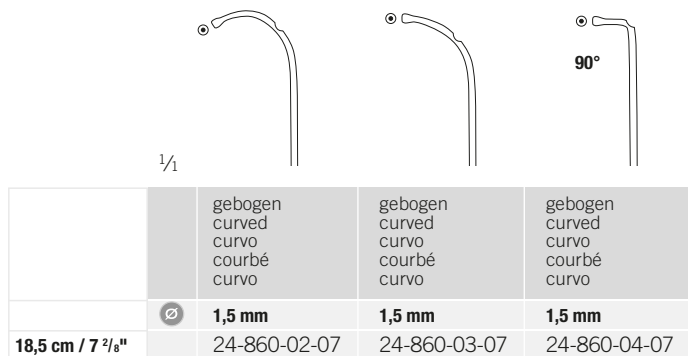

		gebogen curved curvo courbé curvo	gebogen curved curvo courbé curvo	gebogen curved curvo courbé curvo
	∅	<b>1,5 mm</b>	<b>1,5 mm</b>	<b>1,5 mm</b>
<b>18,5 cm / 7 2/8"</b>		24-860-02-07	24-860-03-07	24-860-04-07

Yasargil  
24-860-02-07 -  
24-860-04-07  
18,5 cm / 7 2/8"  
Fadenführer  
Suture guide  
Pinza porta-suturas  
Pince guide-fil  
Pinza porta-filo



## Mikro-Instrumente

Micro instruments  
Micro-instrumentos  
Micro instruments  
Micro-strumenti



1/2

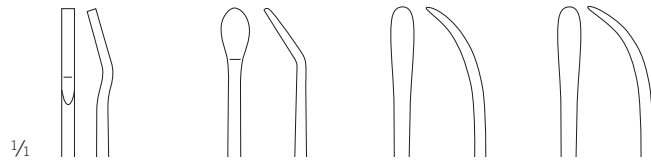

	∅	1,4 mm	4,0 mm	3,0 mm	3,9 mm
18,5 cm / 7 2/8"	St	24-862-01-07	24-862-02-07	24-862-03-07	24-862-04-07

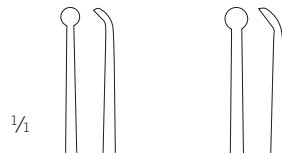

	∅	2,5 mm	3,0 mm
23 cm / 9"	St	24-862-10-07	24-862-11-07

Yasargil  
24-862-01-07 -  
24-862-11-07

Mikro-Raspatorium, gerade  
Micro raspatory, straight  
Micro-raspador, recto  
Micro-raspatoire, droit  
Micro-raspatore, diritto



1/2

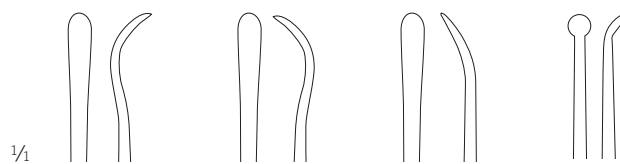

	∅	3,0 mm	3,0 mm	3,0 mm	3,0 mm
18,5 cm / 7 2/8"	St	24-862-05-07	24-862-06-07	24-862-07-07	
23 cm / 9"	St				24-862-20-07

Yasargil  
24-862-05-07 -  
24-862-20-07

Mikro-Raspatorium, bajonett  
Micro raspatory, bayonet  
Micro-raspador, bayoneta  
Micro-raspatoire, baionnette  
Micro-raspatore, baionetta

## Mikro-Instrumente

Micro instruments  
Micro-instrumentos  
Micro instruments  
Micro-strumenti

## Mikro-Instrumente

Micro instruments  
Micro-instrumentos  
Micro-instruments  
Micro-strumenti

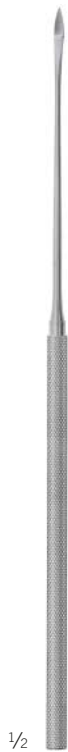

1/2

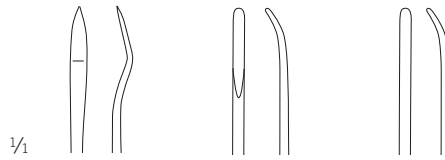

	∅	2,6 mm	2,2 mm	2,2 mm
18,5 cm / 7 7/8"	St	24-863-01-07		
23 cm / 9"	St		24-863-10-07	24-863-12-07

Yasargil

24-863-01-07 -  
24-863-12-07

Mikro-Dissektor, gerade  
Micro dissector, straight  
Micro-dissector, recto  
Micro-dissecteur, droit  
Micro-dissettore, diritto



1/2

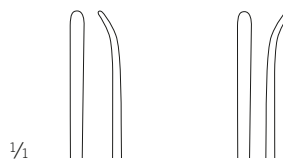

	∅	2,2 mm	2,0 mm
23 cm / 9"	St	24-863-11-07	24-863-13-07

Yasargil

24-863-11-07 -  
24-863-13-07

Mikro-Dissektor, bajonett  
Micro dissector, bayonet  
Micro-dissector, bayoneta  
Micro-dissecteur, baïonnette  
Micro-dissettore, baionetta

## Mikro-Instrumente

Micro instruments  
 Micro-instrumentos  
 Micro instruments  
 Micro-strumenti

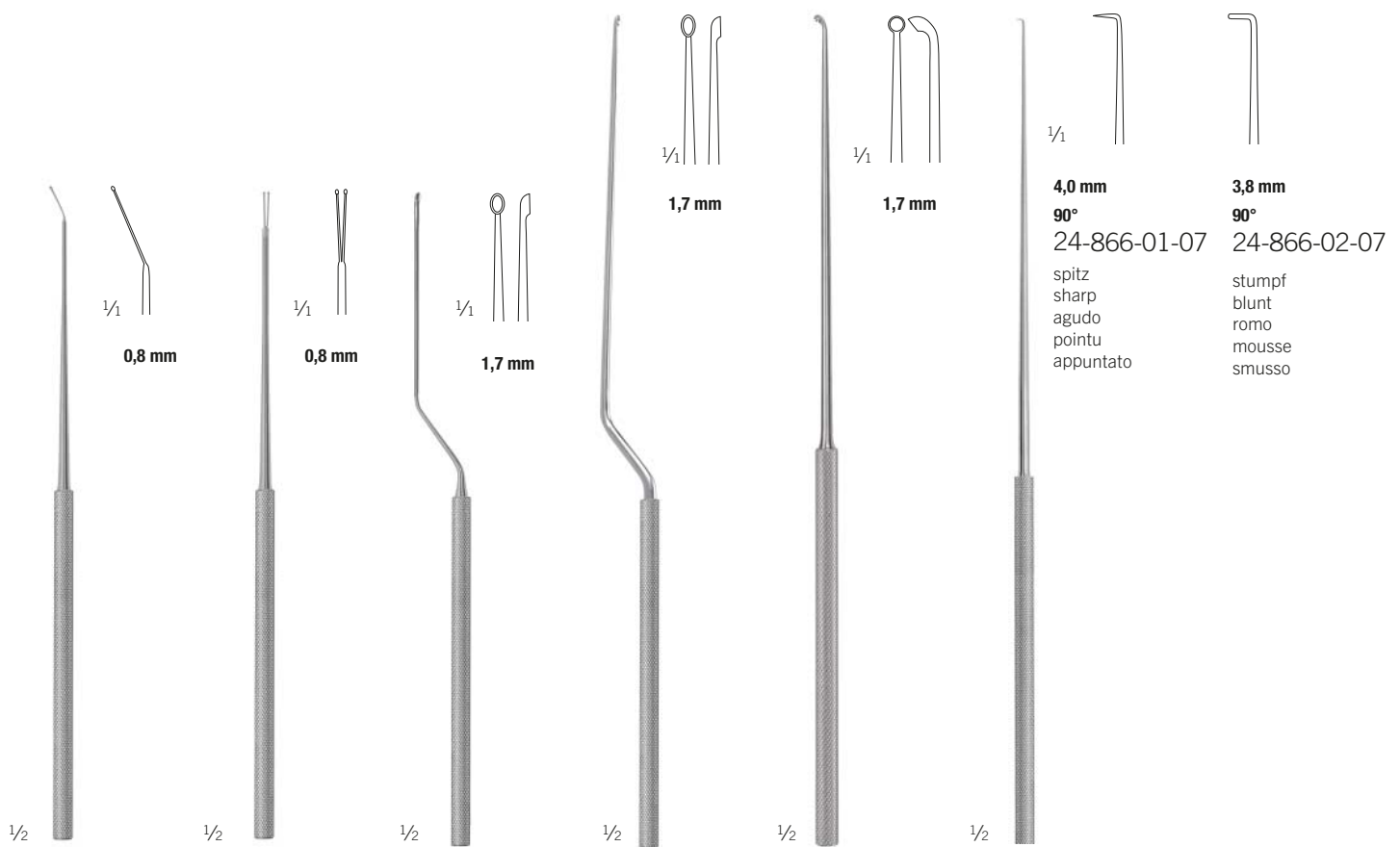

Jacobson  
 24-864-01-07  
 18,5 cm / 7 2/8"  
 Knopfsonde  
 Button probe  
 Sonda abotonada  
 Sonde bouton  
 Sonda bottonuta

Jacobson  
 24-864-02-07  
 18,5 cm / 7 2/8"  
 Doppelsonde  
 Probe, double  
 Sonda doble  
 Sonde double  
 Sonda doppia

Yasargil  
 24-865-01-07  
 18,5 cm / 7 2/8"  
 Mikro-Löffel  
 Micro curette  
 Micro-cucharilla  
 Micro-curette  
 Micro-curetta

24-865-10-07  
 23 cm / 9"  
 Mikro-Löffel  
 Micro curette  
 Micro-cucharilla  
 Micro-curette  
 Micro-curetta

24-865-11-07  
 23 cm / 9"  
 Mikro-Löffel  
 Micro curette  
 Micro-cucharilla  
 Micro-curette  
 Micro-curetta

24-866-01-07 -  
 24-866-02-07  
 Mikro-Häkchen  
 Micro hooklet  
 Micro-gancho  
 Micro-crochet  
 Micro-uncino

## Mikro-Instrumente

Micro instruments  
Micro-instrumentos  
Micro instruments  
Micro-strumenti

## Mikro-Instrumente

Micro instruments  
Micro-instrumentos  
Micro instruments  
Micro-strumenti



1/2

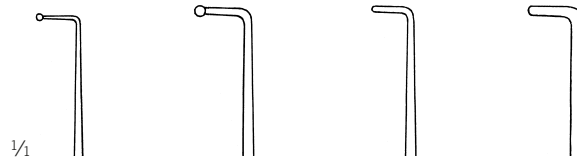

		Krayenbühl	Krayenbühl	Krayenbühl	Krayenbühl
	∅	<b>0,6 mm</b>	<b>1,1 mm</b>	<b>0,6 mm</b>	<b>0,8 mm</b>
		<b>90°</b>	<b>90°</b>	<b>90°</b>	<b>90°</b>
		<b>3,3 mm</b>	<b>4,5 mm</b>	<b>3,2 mm</b>	<b>3,2 mm</b>
<b>19 cm / 7 1/8"</b>	St	24-940-01-07	24-940-02-07	24-940-03-07	24-940-04-07

Krayenbühl  
24-940-01-07 -  
24-940-04-07

Mikro-Häkchen  
Micro hooklet  
Micro-gancho  
Micro-crochet  
Micro-uncino



1/2

isoliert  
insulated  
aislado  
isolée  
isolato

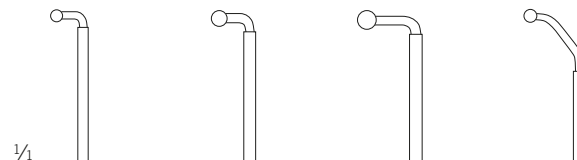

		Caspar	Caspar	Caspar	Caspar
	∅	<b>1,8 mm</b>	<b>2,0 mm</b>	<b>2,5 mm</b>	<b>1,8 mm</b>
		<b>90°</b>	<b>90°</b>	<b>90°</b>	<b>45°</b>
		<b>5 mm</b>	<b>7 mm</b>	<b>9 mm</b>	<b>11 mm</b>
<b>24,5 cm / 9 5/8"</b>	St	24-942-05-07	24-942-07-07	24-942-09-07	24-942-11-07

Caspar  
24-942-05-07 -  
24-942-11-07

Mikro-Häkchen  
Micro hooklet  
Micro-gancho  
Micro-crochet  
Micro-uncino

# Rhoton-Set

Rhoton-Set  
 Juego Rhoton  
 Kit Rhoton  
 Set Rhoton



	Fig. 1	Fig. 2	Fig. 3	Fig. 4
St	24-857-01-07	24-857-02-07	24-857-03-07	24-857-04-07
Ti	24-857-01-09	24-857-02-09	24-857-03-09	24-857-04-09



	Fig. 5	Fig. 6	Fig. 7	Fig. 8
St	24-857-05-07	24-857-06-07	24-857-07-07	24-857-08-07
Ti	24-857-05-09	24-857-06-09	24-857-07-09	24-857-08-09



	Fig. 9	Fig. 10	Fig. 11	Fig. 12
St	24-857-09-07	24-857-10-07	24-857-11-07	24-857-12-07
Ti	24-857-09-09	24-857-10-09	24-857-11-09	24-857-12-09



	Fig. 13	Fig. 14	Fig. 15	Fig. 16
St	24-857-13-07	24-857-14-07	24-857-15-07	24-857-16-07
Ti	24-857-13-09	24-857-14-09	24-857-15-09	24-857-16-09



	Fig. 17	Fig. 18	Fig. 19
St	24-857-17-07	24-857-18-07	24-857-19-07
Ti	24-857-17-09	24-857-18-09	24-857-19-09



Rhoton  
 24-857-01-07 -  
 24-857-19-09  
 19 cm / 7 4/8"

## Rhoton-Set

Rhoton-Set  
Juego Rhoton  
Kit Rhoton  
Set Rhoton

## Mikro-Instrumente

Micro instruments  
Micro-instrumentos  
Micro-instruments  
Micro-strumenti

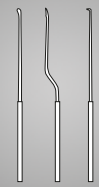

Rhoton  
24-857-00-07

Rhoton-Set, Instrumente aus Edelstahl, bestehend aus Fig. 1 - 19  
Rhoton set, stainless steel instruments, consisting of fig. 1 - 19  
Juego Rhoton, instrumentos acero inoxidable, formado por fig. 1 - 19  
Kit Rhoton, instruments acier inoxydable, composé de fig. 1 - 19  
Set Rhoton, strumenti acciaio inossidabile, consistente in fig. 1 - 19



Rhoton  
24-857-00-09

Rhoton-Set, Instrumente aus Titan, bestehend aus Fig. 1 - 19  
Rhoton set, titanium instruments, consisting of fig. 1 - 19  
Juego Rhoton, instrumentos titanio, formado por fig. 1 - 19  
Kit Rhoton, instruments titane, composé de fig. 1 - 19  
Set Rhoton, strumenti titanio, consistente in fig. 1 - 19



55-803-50-04

Siebkorb für Rhoton-Set, mit Deckel und Fixierelementen (ohne Instrumente)  
Mesh tray for Rhoton set with lid and fixing elements (no instruments)  
Bandeja cribada para juego Rhoton, con tapa e elemento de fijación (sin instrumentos)  
Panier à maille pour kit Rhoton, avec couvercle et éléments de fixation (sans instruments)  
Vassoio per set Rhoton, con coperchio e elemento di fissaggio (senza strumenti)



Allgemeines Instrumentarium

General instruments

Instrumentos generales

Instrumentation générale

Strumentario generale

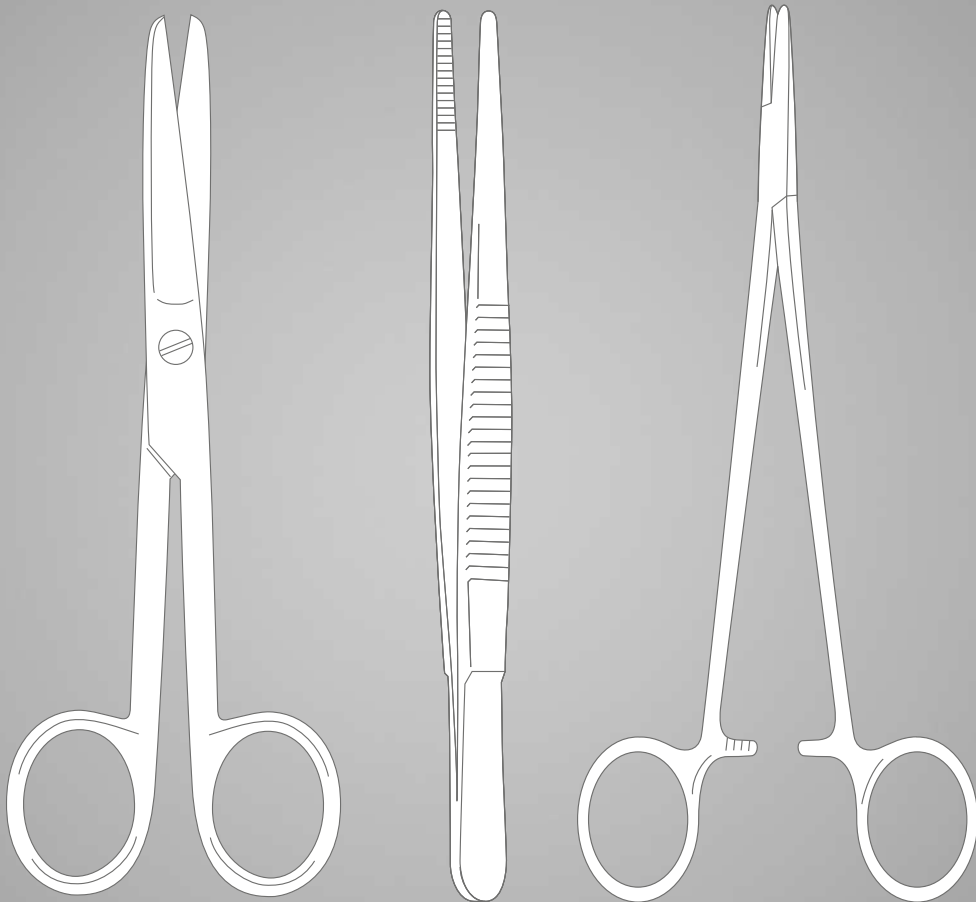





Skalpelle  
Scalpels  
Bisturíes  
Bistouris  
Bisturi

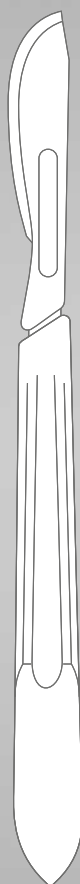

## Skalpellgriffe

Scalpel Handles

Mangos de bisturí

Manches pour bistouris

Manici per bisturi



Fig. 18 - 36

1/2 **Nr. 4**

10-100-04-07

13,5 cm / 5 3/8"

massiv  
solid  
macizo  
solide  
pieno



Fig. 18 - 36

1/2 **Nr. 4L**

10-104-41-07

21 cm / 8 2/8"

massiv  
solid  
macizo  
solide  
pieno



Fig. 10 - 15

1/2 **Nr. 3**

10-130-03-07

12 cm / 4 6/8"

massiv  
solid  
macizo  
solide  
pieno



Fig. 10 - 15

1/2 **Nr. 3L**

10-133-31-07

21,5 cm / 8 4/8"

massiv, lang  
solid, long  
macizo, largo  
solide, long  
pieno, lungo

## Skalpellgriffe

Scalpel Handles

Mangos de bisturí

Manches pour bistouris

Manici per bisturi

## Skalpelle

Scalpels

Bisturíes

Bistouris

Bisturi

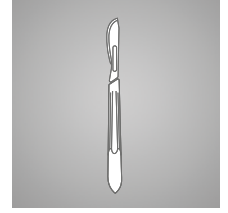

Fig. 10 - 17

1/2 **Nr. 3XL**

10-135-01-07

26 cm / 10 2/8"

massiv, lang  
solid, long  
macizo, largo  
solide, long  
pieno, lungo



Fig. 10 - 17

1/2 **Nr. 7**

10-137-07-07

16 cm / 6 2/8"

massiv  
solid  
macizo  
solide  
pieno



Fig. 66 - 69

1/2

10-160-01-07

13,5 cm / 5 3/8"

für Mikro-Skalpellklingen  
for micro scalpel blades  
para micro-hojas de bisturí  
pour micro-lames de bistouris  
per micro-lame per bisturi

## Skalpellklingen

Scalpel Blades  
 Hojas de bisturí  
 Lames de bistouris  
 Lame per bisturi

einzel verpackt, VE = 100 Stück  
 single packed, SU = 100/pack  
 envase individual, UV = 100 piezas  
 enveloppe individuelle, UC = 100 untiés  
 bustina individuale, UV = 100 pezzi



10-199-00-01

Skalpellklingen-Entferner  
 Scalpel Blade Remover  
 Quita-hojas  
 Enlève-lame  
 Distributore lame

1/1

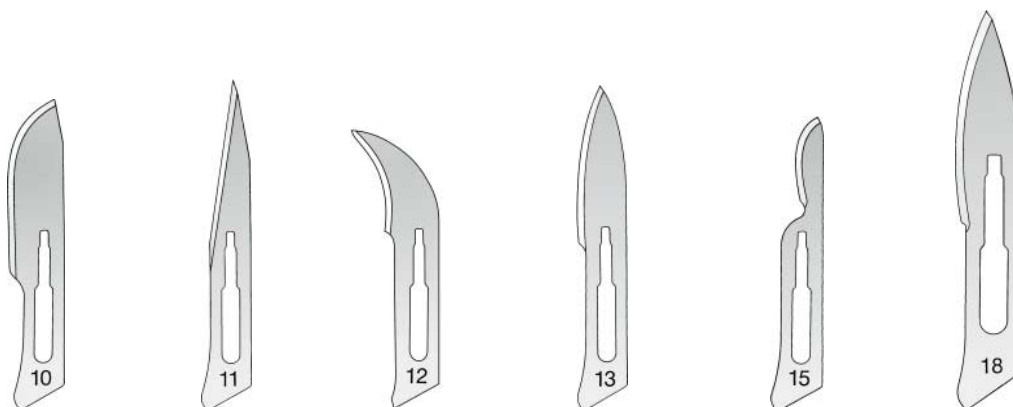

	Fig. 10	Fig. 11	Fig. 12	Fig. 13	Fig. 15	Fig. 18
<b>STERILE IR</b>	10-155-10-04	10-155-11-04	10-155-12-04	10-155-13-04	10-155-15-04	10-155-18-04

1/1

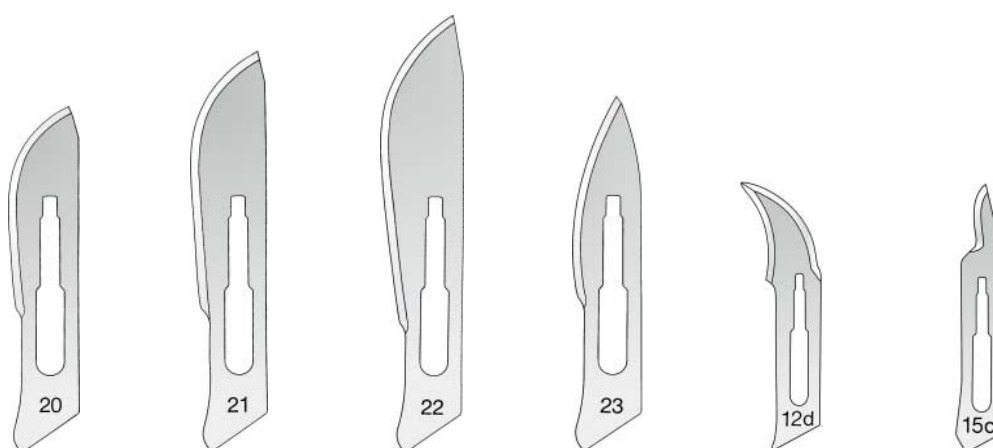

	Fig. 20	Fig. 21	Fig. 22	Fig. 23	Fig. 12 D	Fig. 15 C
<b>STERILE IR</b>	10-155-20-04	10-155-21-04	10-155-22-04	10-155-23-04	10-156-12-04	10-156-15-04

## Einmalskalpelle

Disposable Scalpels  
Bisturíes desechables  
Bistouris à usage unique  
Bisturi per uso unico

## Skalpelle

Scalpels  
Bisturíes  
Bistouris  
Bisturi



### STERILE | R

steril  
einzeln verpackt  
Packung mit 10 Stück

sterile  
single packed  
package with 10 units

estéril  
envase individual  
paquete con 10 unidades

stérile  
enveloppe individuelle  
boîte de 10 bisturis

sterile  
bustina individuale  
scatola di 10 bisturi

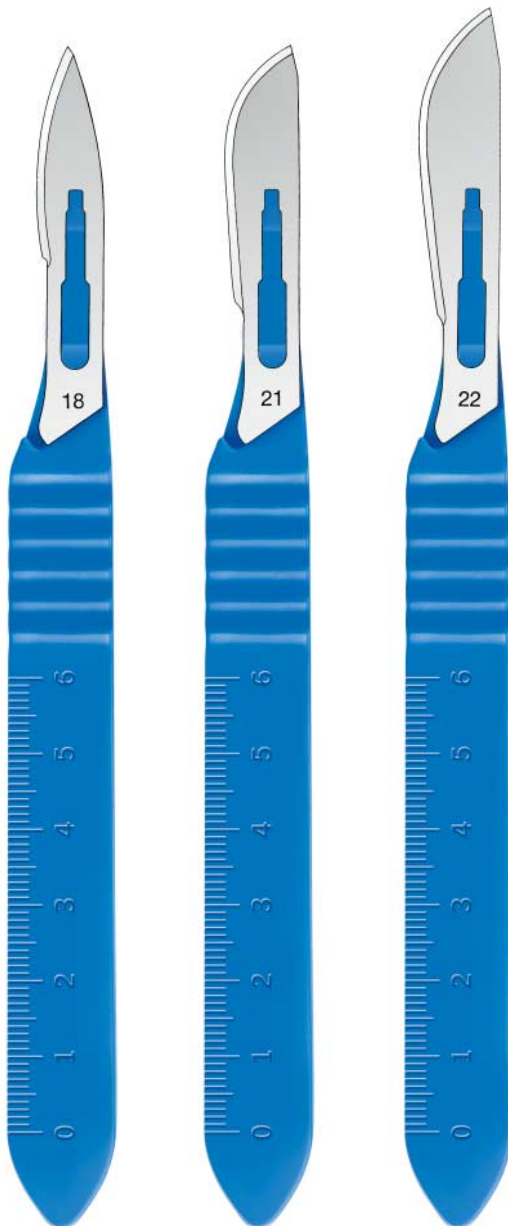
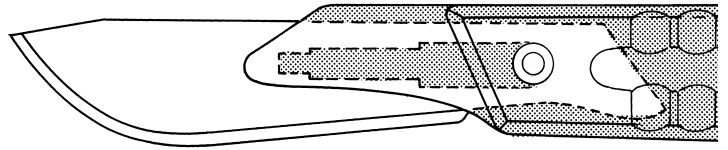

1/1

	Fig. 18	Fig. 21	Fig. 22
STERILE   R	10-285-18-04	10-285-21-04	10-285-22-04

# Einmalskalpelle

Disposable Scalpels  
Bisturíes desechables  
Bistouris à usage unique  
Bisturi per uso unico

## STERILE | R

steril  
einzeln verpackt  
Packung mit 10 Stück

sterile  
single packed  
package with 10 units

estéril  
envase individual  
paquete con 10 unidades

stérile  
enveloppe individuelle  
boîte de 10 bisturis

sterile  
bustina individuale  
scatola di 10 bisturi

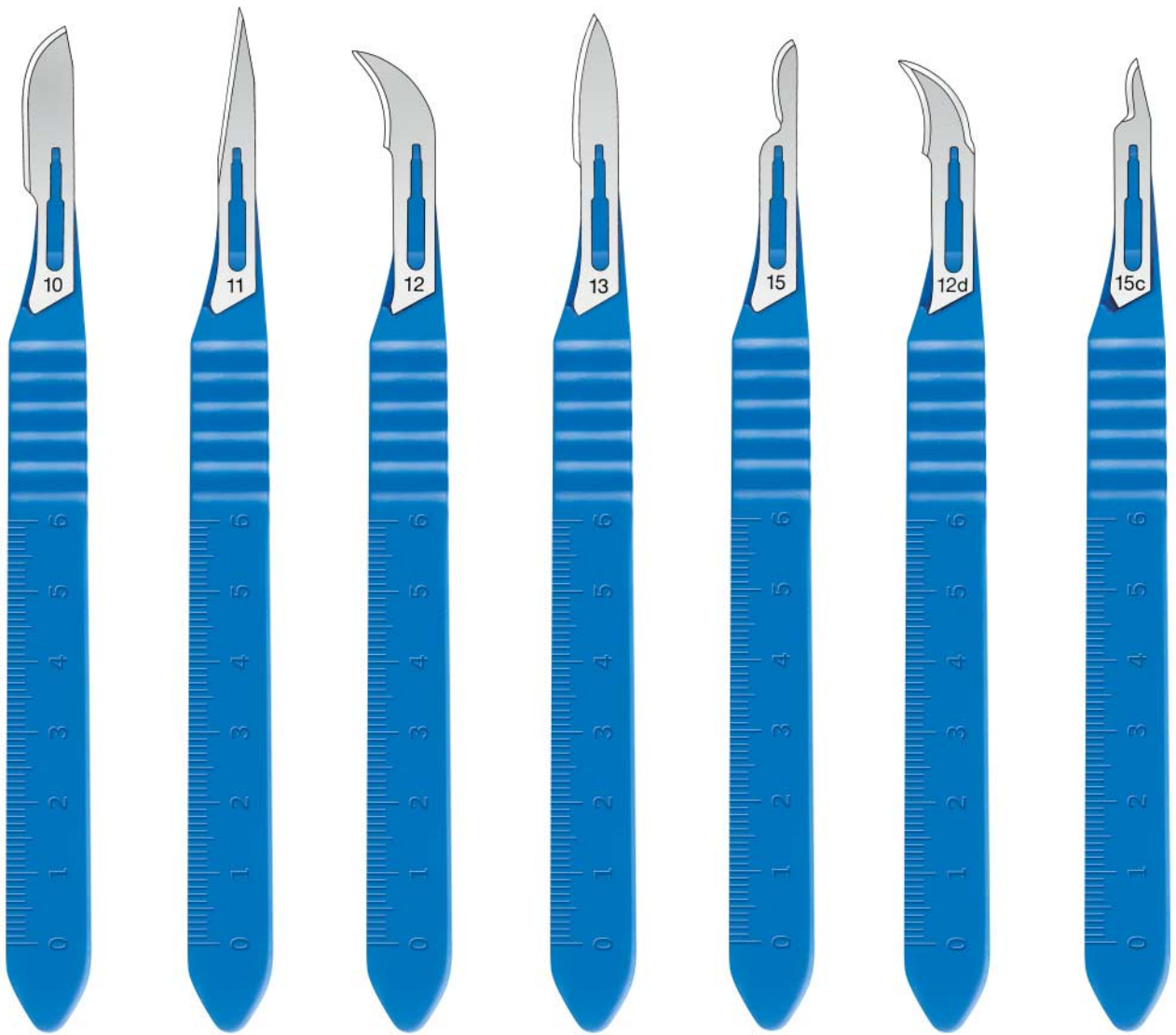

1/1

	Fig. 10	Fig. 11	Fig. 12	Fig. 13	Fig. 15	Fig. 12 D	Fig. 15 C
STERILE   R	10-295-10-04	10-295-11-04	10-295-12-04	10-295-13-04	10-295-22-04	10-296-12-04	10-296-15-04

Scheren  
Scissors  
Tijeras  
Ciseaux  
Forbici

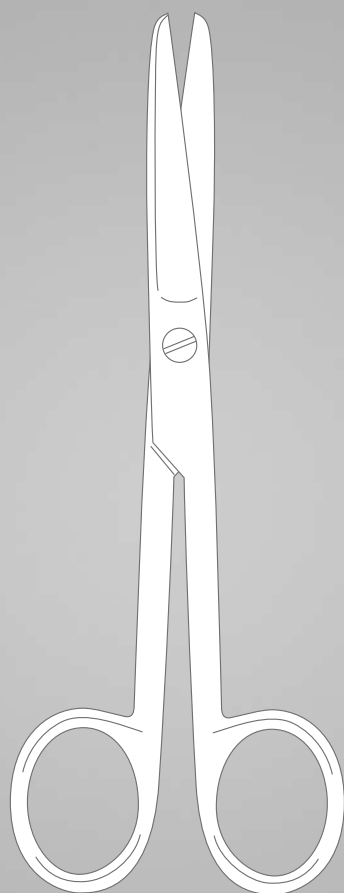



# Chirurgische Scheren

Operating Scissors

Tijeras quirúrgicas

Ciseaux chirurgicaux

Forbici per chirurgia



	Standard	TCGOLD
12 cm / 4 6/8"	11-100-11-07	
13 cm / 5 1/8"	11-100-13-07	
14,5 cm / 5 6/8"	11-100-14-07	11-902-14-07
16,5 cm / 6 4/8"	11-100-16-07	
18,5 cm / 7 2/8"	11-100-18-07	
20,5 cm / 8 1/8"	11-100-20-07	

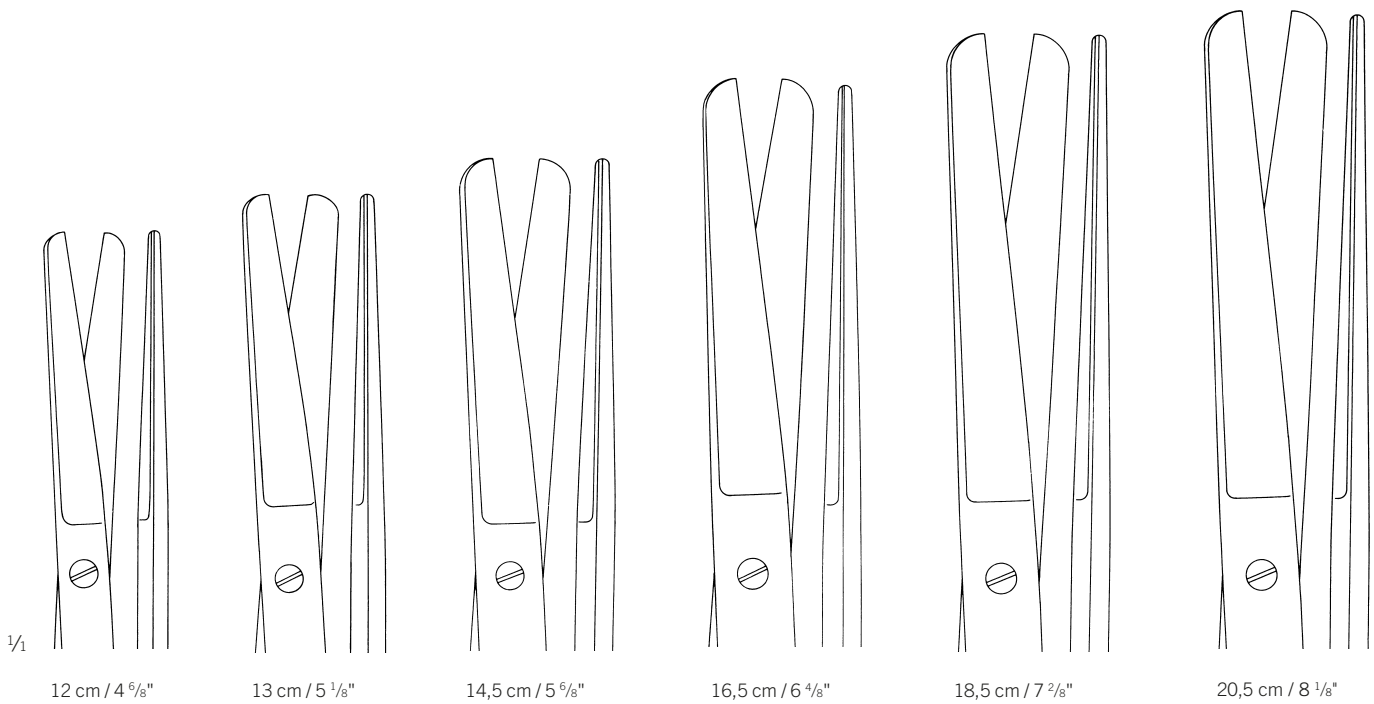

# Chirurgische Scheren

Operating Scissors  
Tijeras quirúrgicas  
Ciseaux chirurgicaux  
Forbici per chirurgia

# Scheren

Scissors  
Tijeras  
Ciseaux  
Forbici



	Standard	TCGOLD	SuperCut
12 cm / 4 6/8"	11-102-11-07		
13 cm / 5 1/8"	11-102-13-07		
14,5 cm / 5 6/8"	11-102-14-07	11-904-14-07	11-650-14-07
16,5 cm / 6 4/8"	11-102-16-07		
18,5 cm / 7 2/8"	11-102-18-07		
20,5 cm / 8 1/8"	11-102-20-07		

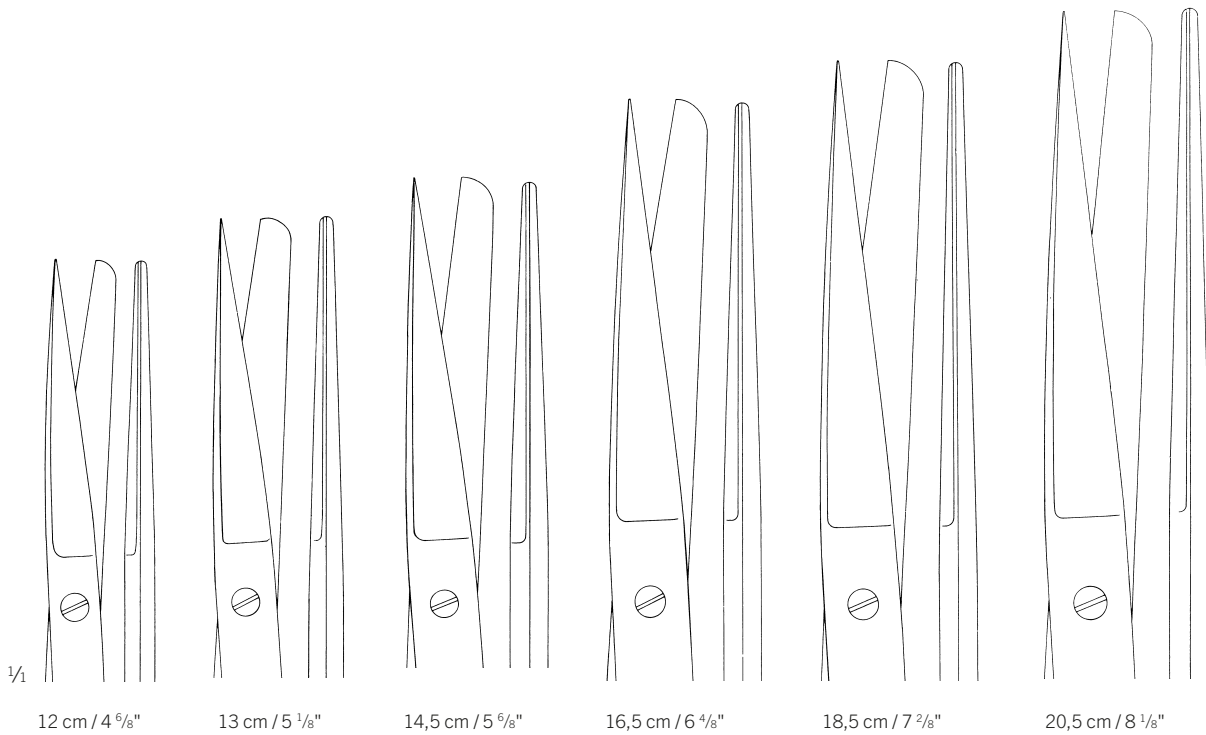

12 cm / 4 6/8"

13 cm / 5 1/8"

14,5 cm / 5 6/8"

16,5 cm / 6 4/8"

18,5 cm / 7 2/8"

20,5 cm / 8 1/8"

## Chirurgische Scheren

Operating Scissors

Tijeras quirúrgicas

Ciseaux chirurgicaux

Forbici per chirurgia



	Standard	TCGOLD
12 cm / 4 6/8"	11-104-11-07	
13 cm / 5 1/8"	11-104-13-07	
14,5 cm / 5 6/8"	11-104-14-07	11-906-14-07
16,5 cm / 6 4/8"	11-104-16-07	

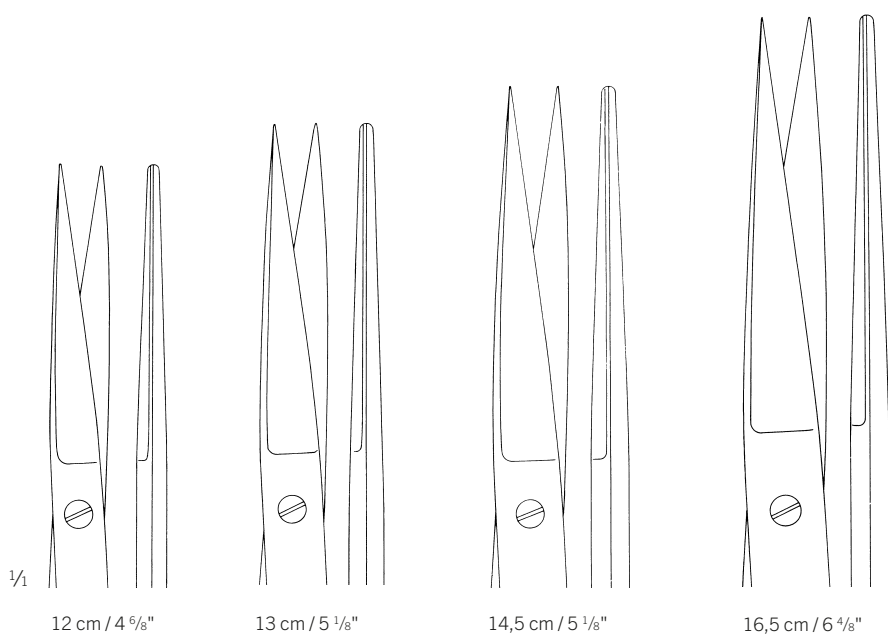

# Chirurgische Scheren

Operating Scissors  
Tijeras quirúrgicas  
Ciseaux chirurgicaux  
Forbici per chirurgia

# Scheren

Scissors  
Tijeras  
Ciseaux  
Forbici



	Standard	TCGOLD
12 cm / 4 6/8"	11-105-11-07	
13 cm / 5 1/8"	11-105-13-07	
14,5 cm / 5 6/8"	11-105-14-07	11-903-14-07
16,5 cm / 6 4/8"	11-105-16-07	
18,5 cm / 7 2/8"	11-105-18-07	
20,5 cm / 8 1/8"	11-105-20-07	

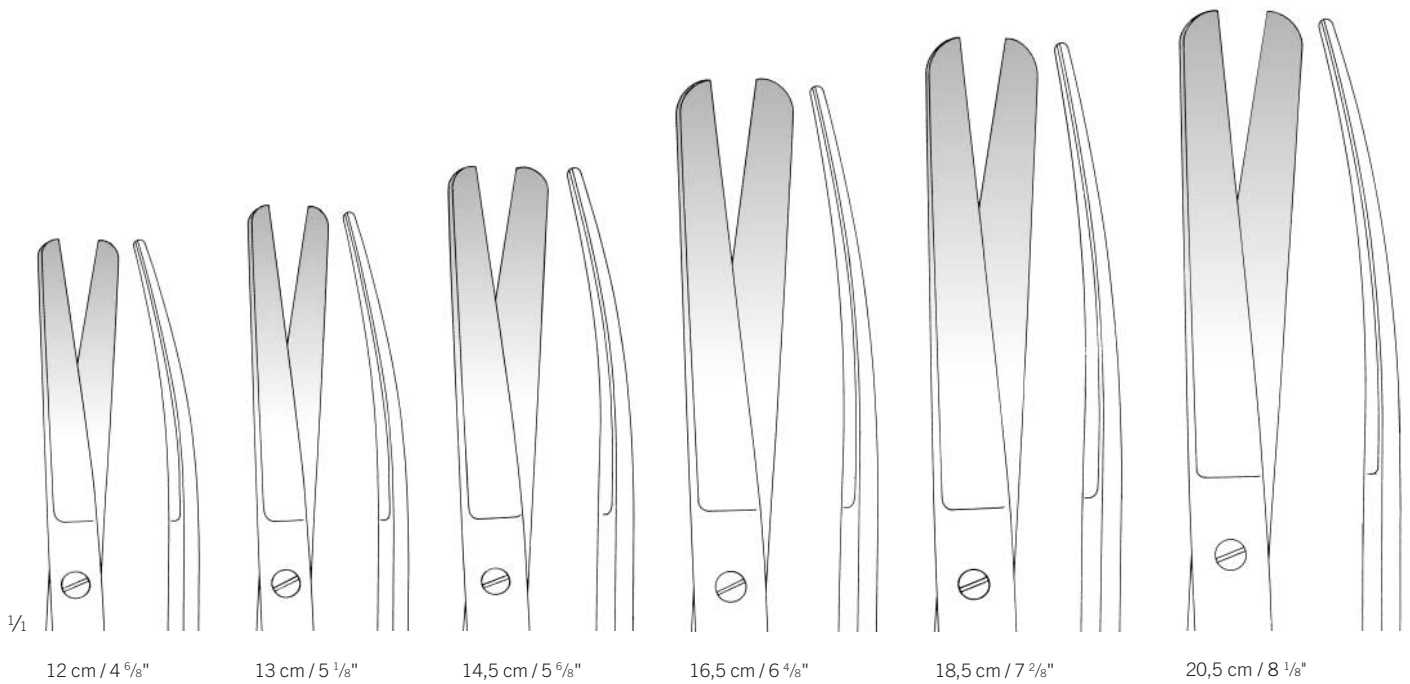

# Chirurgische Scheren

Operating Scissors

Tijeras quirúrgicas

Ciseaux chirurgicaux

Forbici per chirurgia



	Standard	TCGOLD	SuperCut
12 cm / 4 6/8"	11-107-11-07		
13 cm / 5 1/8"	11-107-13-07		
14,5 cm / 5 6/8"	11-107-14-07	11-905-14-07	11-651-14-07
16,5 cm / 6 4/8"	11-107-16-07		
18,5 cm / 7 2/8"	11-107-18-07		
20,5 cm / 8 1/8"	11-107-20-07		

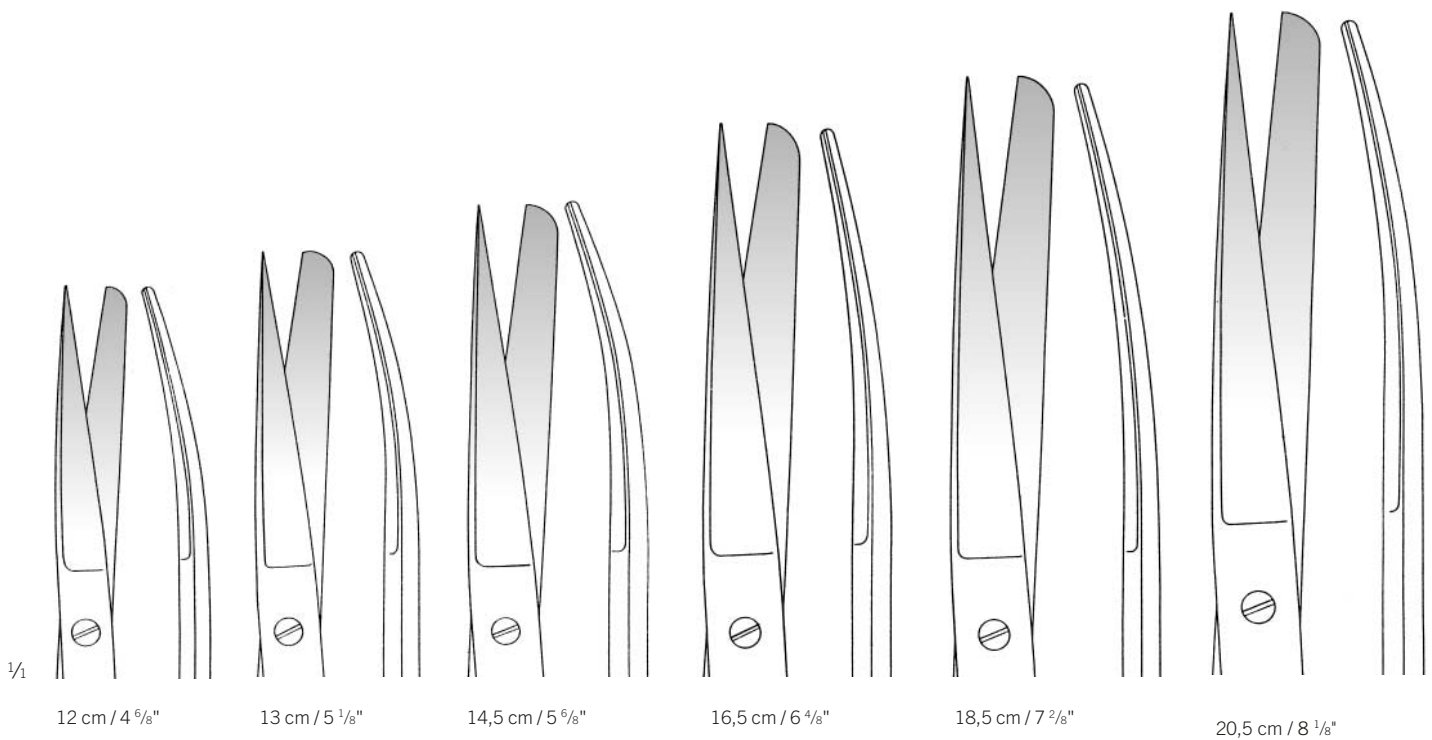

## Chirurgische Scheren

Operating Scissors  
Tijeras quirúrgicas  
Ciseaux chirurgicaux  
Forbici per chirurgia

## Scheren

Scissors  
Tijeras  
Ciseaux  
Forbici



	Standard	TCGOLD
12 cm / 4 6/8"	11-109-11-07	
13 cm / 5 1/8"	11-109-13-07	
14,5 cm / 5 6/8"	11-109-14-07	11-907-14-07
16,5 cm / 6 4/8"	11-109-16-07	

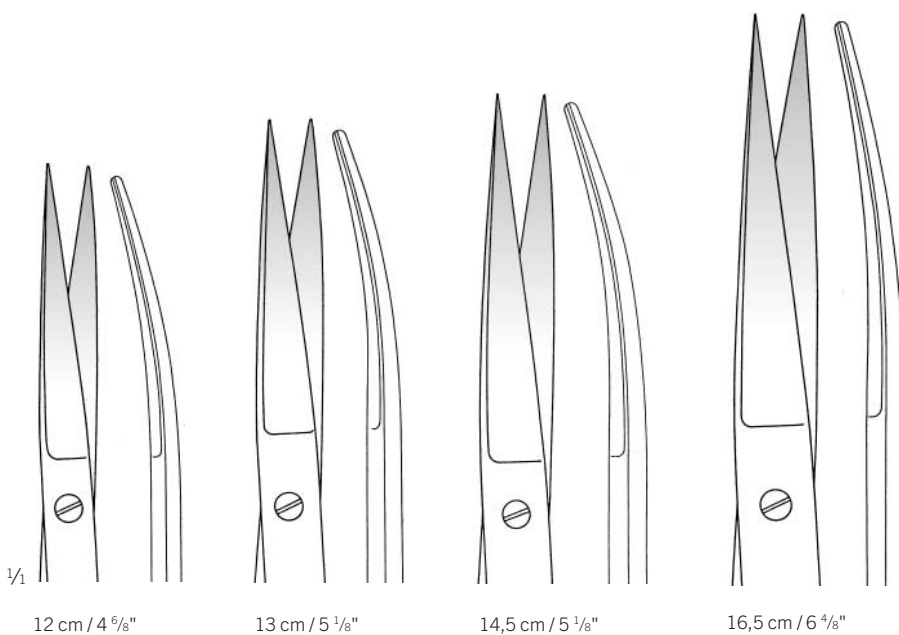

12 cm / 4 6/8"

13 cm / 5 1/8"

14,5 cm / 5 6/8"

16,5 cm / 6 4/8"

## Chirurgische Scheren

Operating Scissors

Tijeras quirúrgicas

Ciseaux chirurgicaux

Forbici per chirurgia

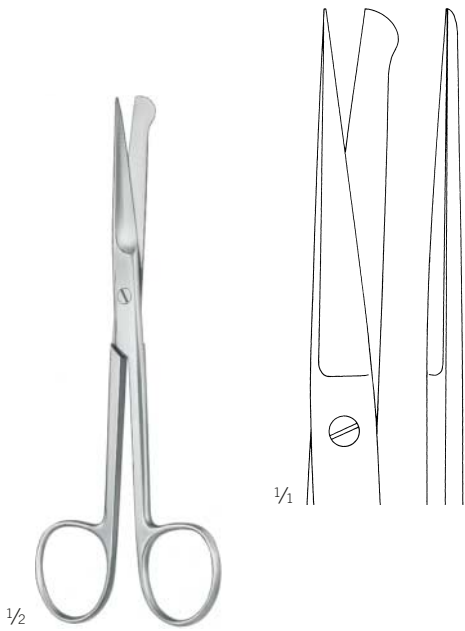

11-136-14-07

14,5 cm / 5 7/8"

Inzisionsschere

Incision Scissors

Tijera para incisiones

Ciseaux à incision

Forbici per incisione

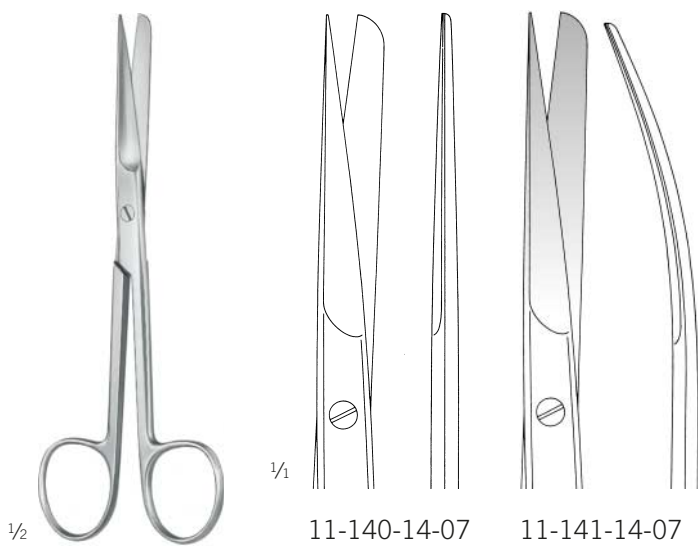

11-140-14-07

11-141-14-07

Deaver

11-140-14-07 -

11-141-14-07

14,5 cm / 5 7/8"

# Präparierscheren

Dissecting Scissors  
Tijeras de disección  
Ciseaux à dissection  
Forbici per dissezione

# Scheren

Scissors  
Tijeras  
Ciseaux  
Forbici



Mayo	Standard	TCGOLD	SuperCut	AQUILA
14 cm / 5 4/8"				28-466-14-07
14,5 cm / 5 6/8"	11-170-14-07	11-910-14-07	11-652-14-07	
17 cm / 6 6/8"	11-170-17-07	11-910-17-07	11-652-17-07	28-466-17-07
23 cm / 9"		11-910-23-07		
23,5 cm / 9 2/8"	11-170-23-07		11-652-23-07	

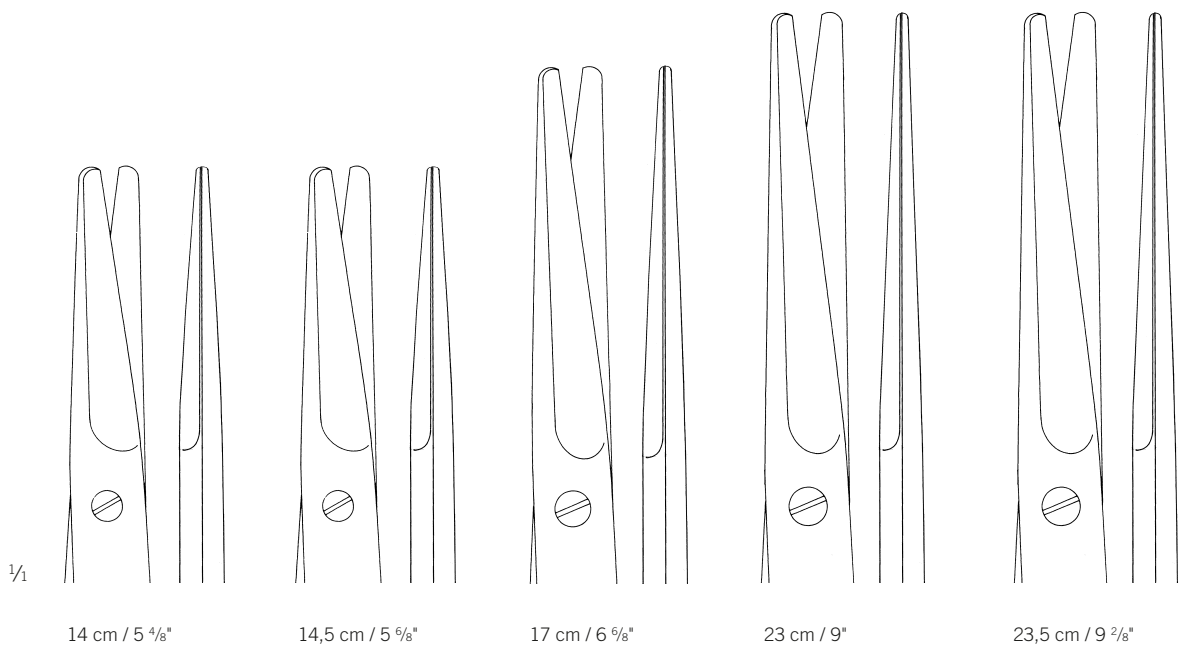

14 cm / 5 4/8"

14,5 cm / 5 6/8"

17 cm / 6 6/8"

23 cm / 9"

23,5 cm / 9 2/8"



# Präparierscheren

Dissecting Scissors  
Tijeras de disección  
Ciseaux à dissection  
Forbici per dissezione



Mayo	Standard	TCGOLD	SuperCut	AQUILA
14 cm / 5 1/8"				28-467-14-07
14,5 cm / 5 7/8"	11-171-14-07	11-911-14-07	11-653-14-07	
17 cm / 6 5/8"	11-171-17-07	11-911-17-07	11-653-17-07	28-467-17-07
23 cm / 9"		11-911-23-07		
23,5 cm / 9 1/2"	11-171-23-07		11-653-23-07	

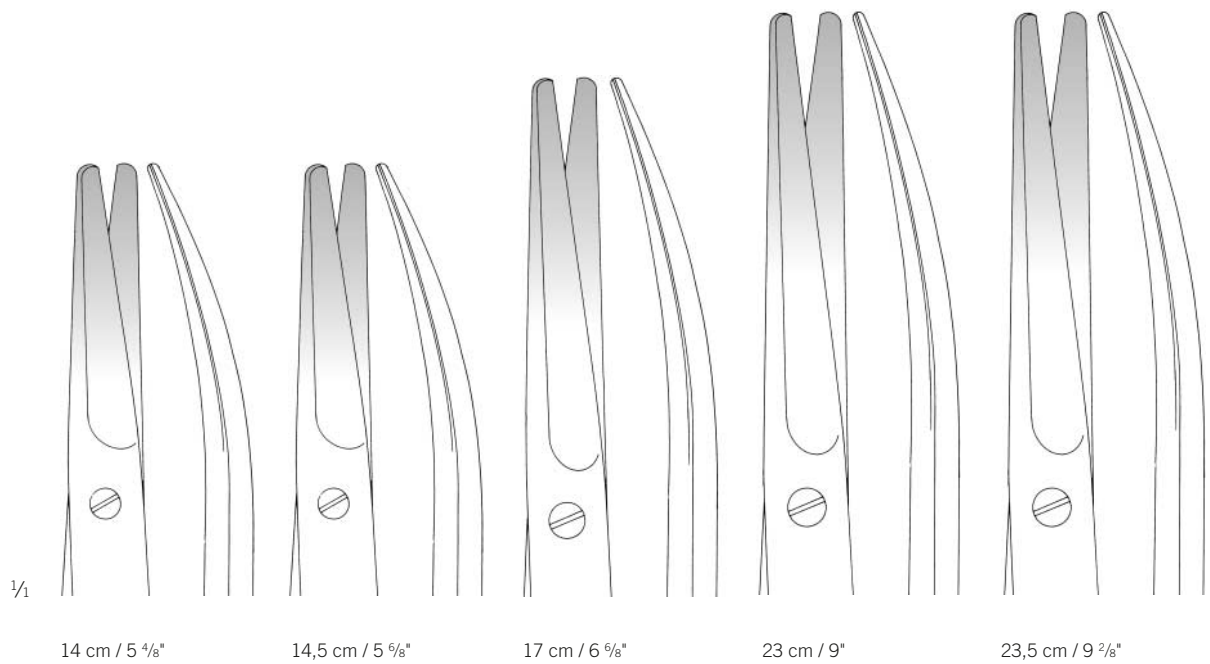

# Präparierscheren

Dissecting Scissors  
Tijeras de disección  
Ciseaux à dissection  
Forbici per dissezione

# Scheren

Scissors  
Tijeras  
Ciseaux  
Forbici



Mayo-Stille	Standard	TCGOLD	SuperCut
14,5 cm / 5 7/8"		11-930-15-07	
15 cm / 5 7/8"	11-180-15-07		11-654-15-07
17 cm / 6 5/8"	11-180-17-07	11-930-17-07	11-654-17-07
19,5 cm / 7 5/8"	11-184-19-07		

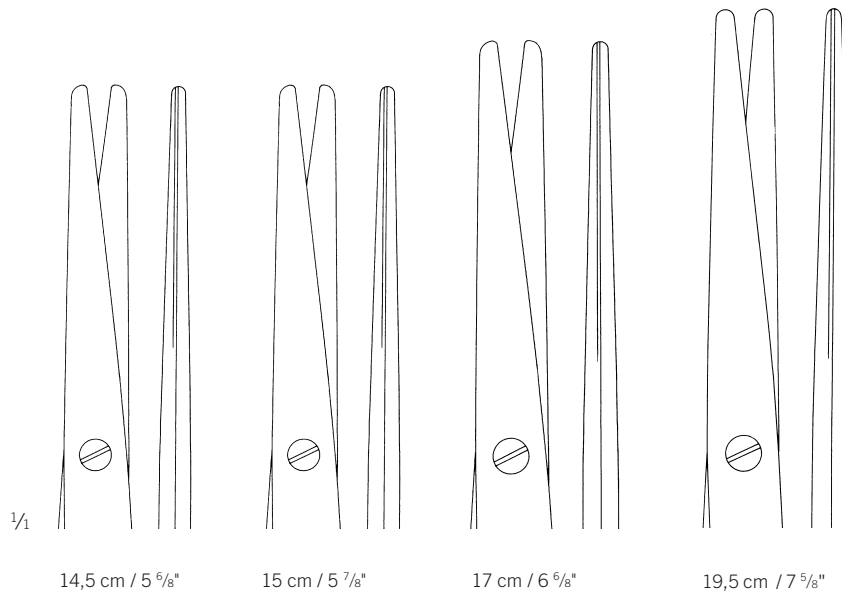

# Präparierscheren

Dissecting Scissors  
Tijeras de disección  
Ciseaux à dissection  
Forbici per dissezione



Mayo-Stille	Standard	TCGOLD	SuperCut	AQUILA
14,5 cm / 5 7/8"		11-931-15-07		
15 cm / 5 7/8"	11-181-15-07		11-655-15-07	28-471-15-07
17 cm / 6 5/8"	11-181-17-07	11-931-17-07	11-655-17-07	28-471-17-07
19,5 cm / 7 5/8"	11-185-19-07			
21,5 cm / 8 4/8"	11-185-21-07			

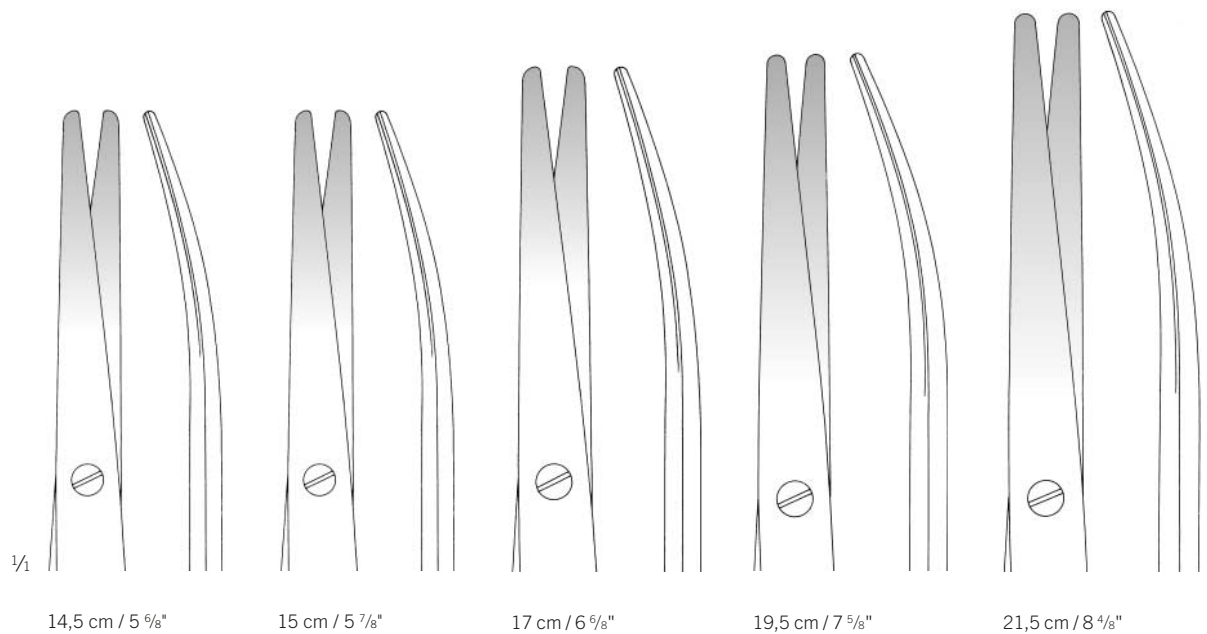

## Präparierscheren

Dissecting Scissors  
Tijeras de disección  
Ciseaux à dissection  
Forbici per dissezione

## Scheren

Scissors  
Tijeras  
Ciseaux  
Forbici



1/2

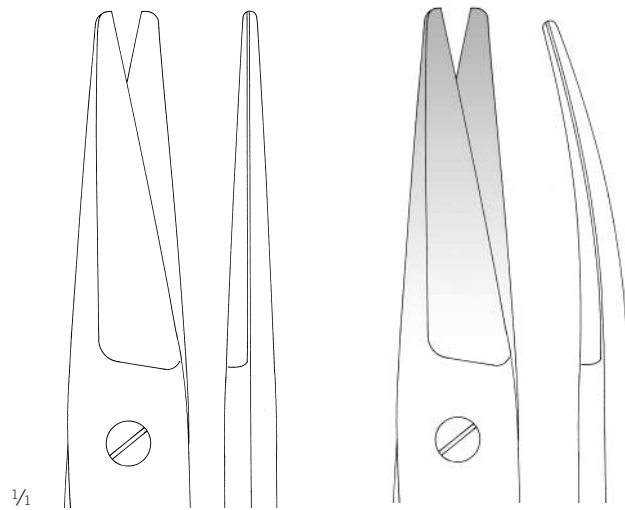

1/1

11-190-17-07

11-191-17-07

Mayo-Noble  
11-190-17-07 -  
11-191-17-07  
16,5 cm / 6 4/8"

# Chirurgische Scheren

Operating Scissors  
 Tijeras quirúrgicas  
 Ciseaux chirurgicaux  
 Forbici per chirurgia



Kelly	Standard	TCGOLD	SuperCut	AQUILA
16 cm / 6 2/8"	11-226-16-07	11-992-16-07	11-656-16-07	28-474-16-07

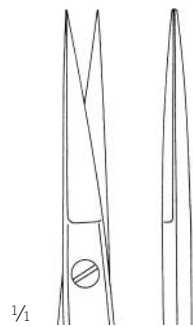

16 cm / 6 2/8"

# Chirurgische Scheren

Operating Scissors  
Tijeras quirúrgicas  
Ciseaux chirurgicaux  
Forbici per chirurgia

# Scheren

Scissors  
Tijeras  
Ciseaux  
Forbici



Kelly	Standard	TCGOLD	SuperCut	AQUILA
16 cm / 6 2/8"	11-227-16-07	11-993-16-07	11-657-16-07	28-475-16-07

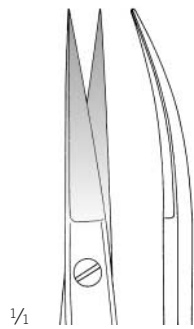

16 cm / 6 2/8"

## Präparierscheren

Dissecting Scissors  
Tijeras de disección  
Ciseaux à dissection  
Forbici per dissezione



Metzenbaum	Standard	TCGOLD	SuperCut
11,5 cm / 4 7/8"	11-248-11-07	11-936-11-07	11-658-11-07
14,5 cm / 5 6/8"	11-250-14-07	11-938-14-07	11-658-14-07

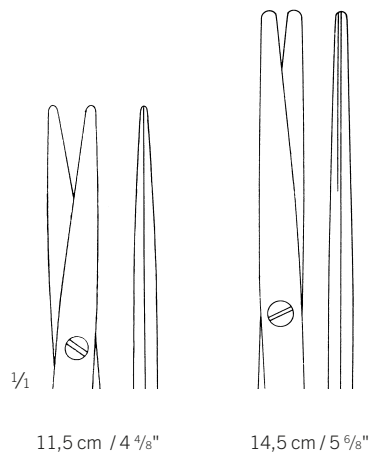

## Präparierscheren

Dissecting Scissors  
Tijeras de disección  
Ciseaux à dissection  
Forbici per dissezione

## Scheren

Scissors  
Tijeras  
Ciseaux  
Forbici

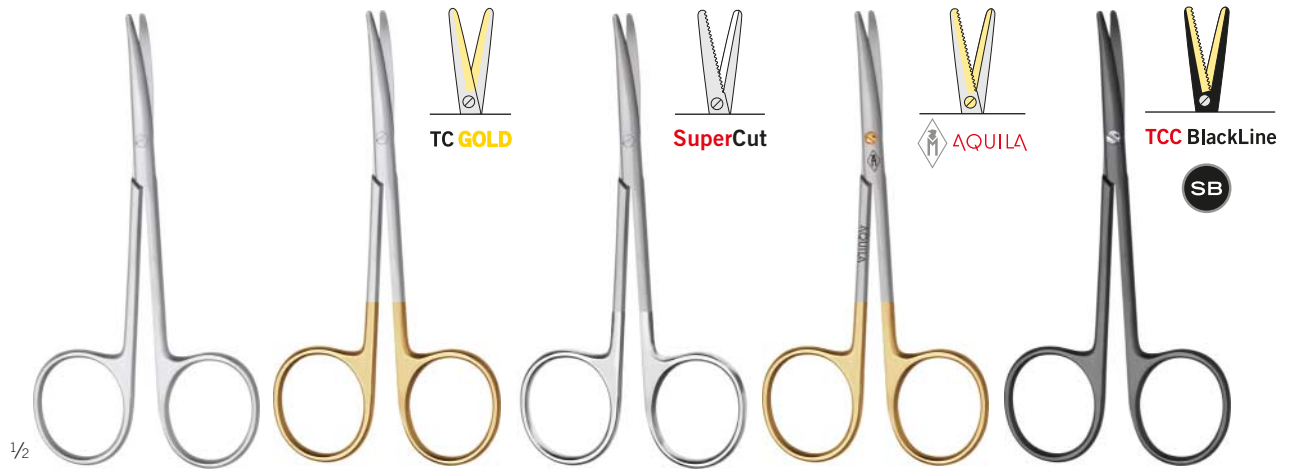
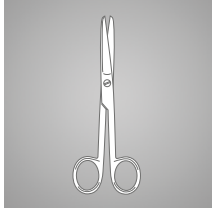

Metzenbaum	Standard	TCGOLD	SuperCut	AQUILA	TCCBlackLine
11,5 cm / 4 1/8"	11-249-11-07	11-937-11-07	11-659-11-07		
12 cm / 4 6/8"				11-887-11-07	11-917-11-07
14,5 cm / 5 6/8"	11-255-14-07	11-939-14-07	11-659-14-07		

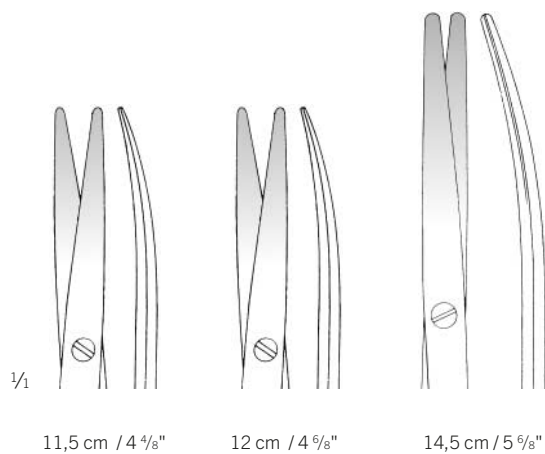

11,5 cm / 4 1/8"

12 cm / 4 6/8"

14,5 cm / 5 6/8"



## Präparierscheren

Dissecting Scissors  
Tijeras de disección  
Ciseaux à dissection  
Forbici per dissezione

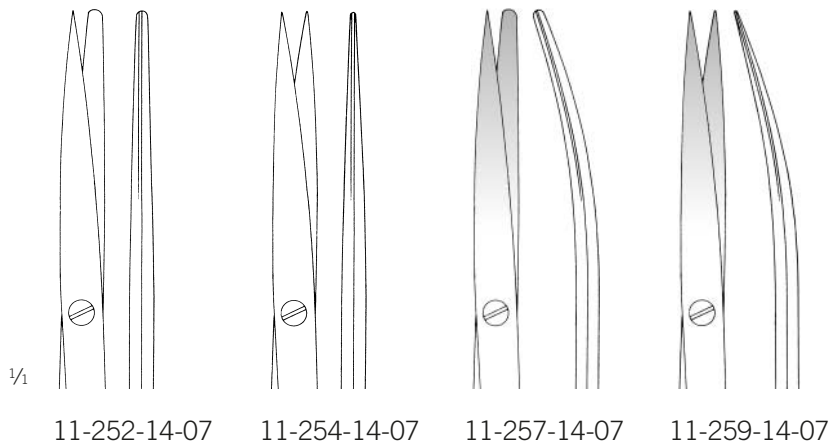

Metzenbaum  
11-252-14-07 -  
11-259-14-07  
14,5 cm / 5 7/8"

# Präparierscheren

Dissecting Scissors  
Tijeras de disección  
Ciseaux à dissection  
Forbici per dissezione

# Scheren

Scissors  
Tijeras  
Ciseaux  
Forbici



Metzenbaum	Standard	TCGOLD	SuperCut	AQUILA
15,5 cm / 6 1/8"	11-264-15-07			
18 cm / 7 1/8"	11-280-18-07	11-942-18-07	11-660-18-07	
20 cm / 7 7/8"				28-472-20-07
20,5 cm / 8 1/8"	11-280-20-07	11-942-20-07	11-660-20-07	
23 cm / 9"	11-280-23-07	11-942-23-07	11-660-23-07	28-472-23-07
26 cm / 10 2/8"	11-280-25-07	11-942-25-07	11-660-26-07	
28,5 cm / 11 2/8"	11-280-28-07	11-942-28-07	11-660-28-07	
31 cm / 12 2/8"	11-280-30-07	11-942-30-07	11-660-31-07	

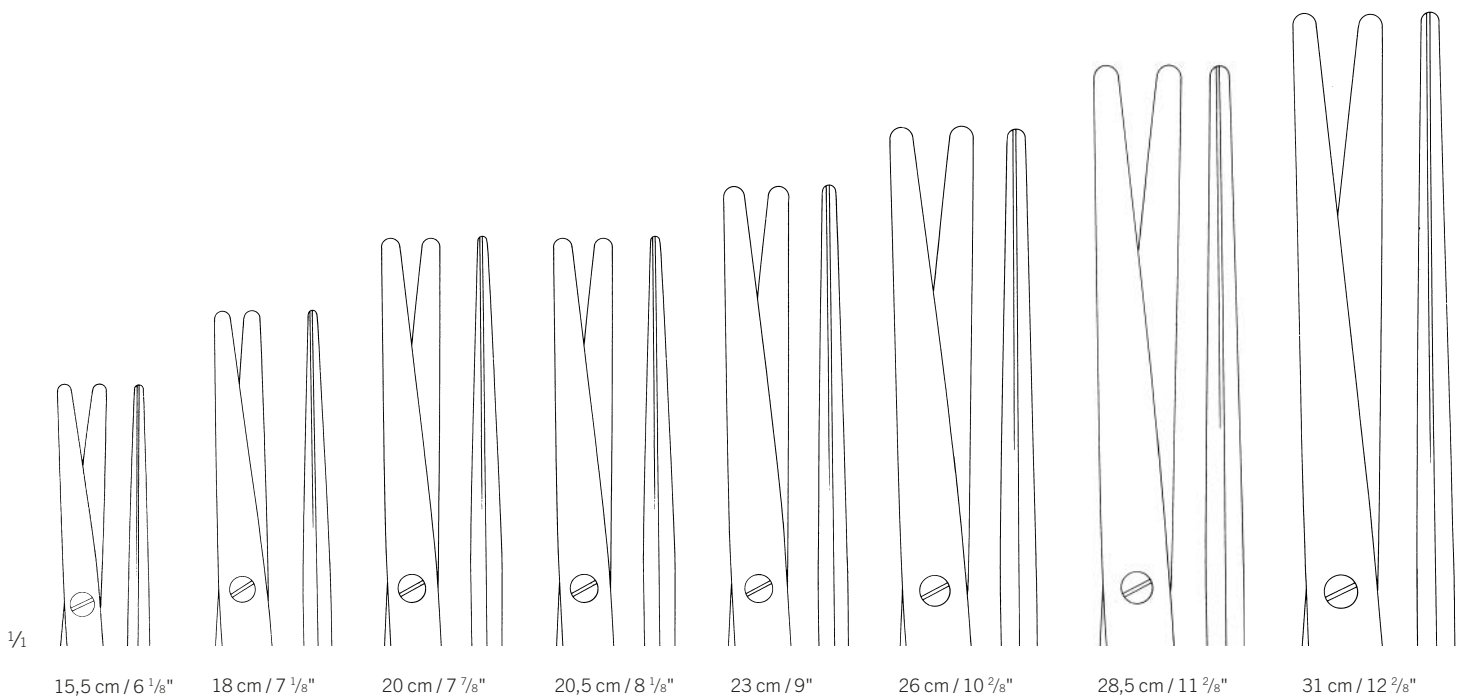

# Präparierscheren

Dissecting Scissors  
Tijeras de disección  
Ciseaux à dissection  
Forbici per dissezione



Metzenbaum	Standard	TCGOLD	SuperCut
15,5 cm / 6 1/8"	11-265-15-07		
18 cm / 7 1/8"	11-285-18-07	11-943-18-07	11-661-18-07
20,5 cm / 8 1/8"	11-285-20-07	11-943-20-07	11-661-20-07
23 cm / 9"	11-285-23-07	11-943-23-07	11-661-23-07
25 cm / 9 6/8"			
26 cm / 10 2/8"	11-285-25-07	11-943-25-07	11-661-26-07
28,5 cm / 11 2/8"	11-285-28-07	11-943-28-07	11-661-28-07
30 cm / 11 6/8"		11-943-30-07	
31 cm / 12 2/8"	11-285-30-07		11-661-31-07

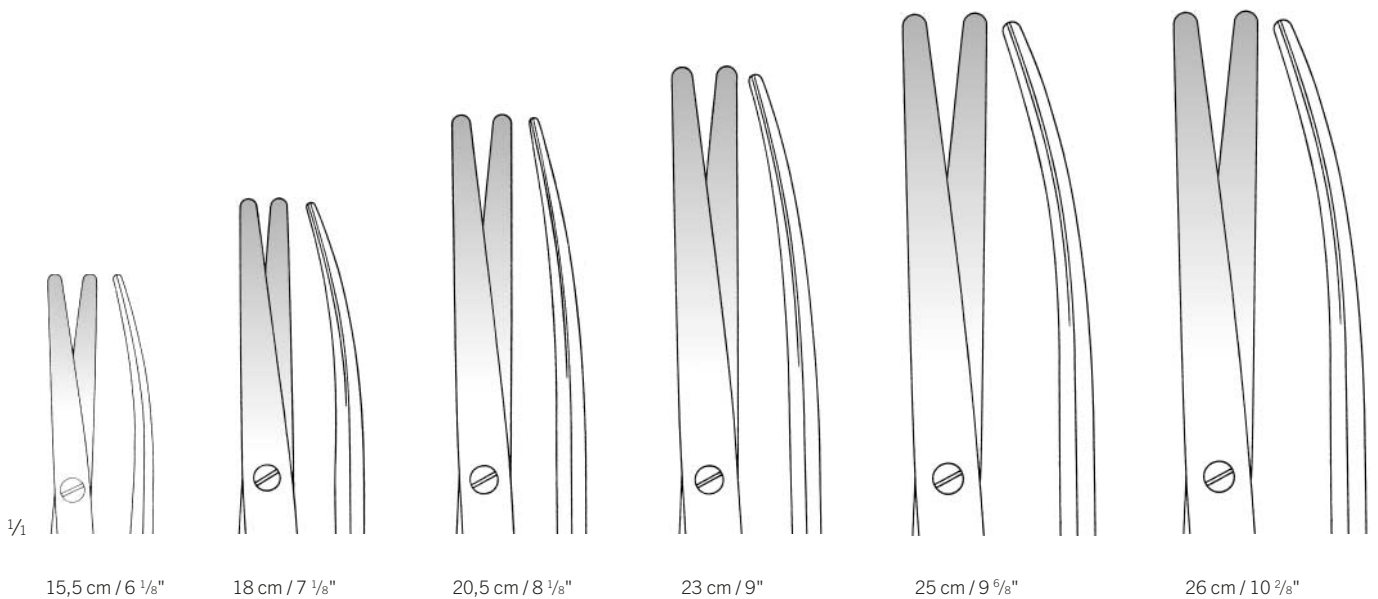

## Präparierscheren

Dissecting Scissors  
Tijeras de disección  
Ciseaux à dissection  
Forbici per dissezione

## Scheren

Scissors  
Tijeras  
Ciseaux  
Forbici



Metzenbaum	 AQUILA	TCCBlackLine
15,5 cm / 6 1/8"		
18 cm / 7 1/8"	11-887-18-07	11-917-18-07
20,5 cm / 8 1/8"	11-887-20-07	11-917-20-07
23 cm / 9"	11-887-23-07	11-917-23-07
25 cm / 9 6/8"	11-887-25-07	11-917-25-07
26 cm / 10 2/8"		
28,5 cm / 11 2/8"		
30 cm / 11 6/8"	11-887-30-07	11-917-30-07
31 cm / 12 2/8"		

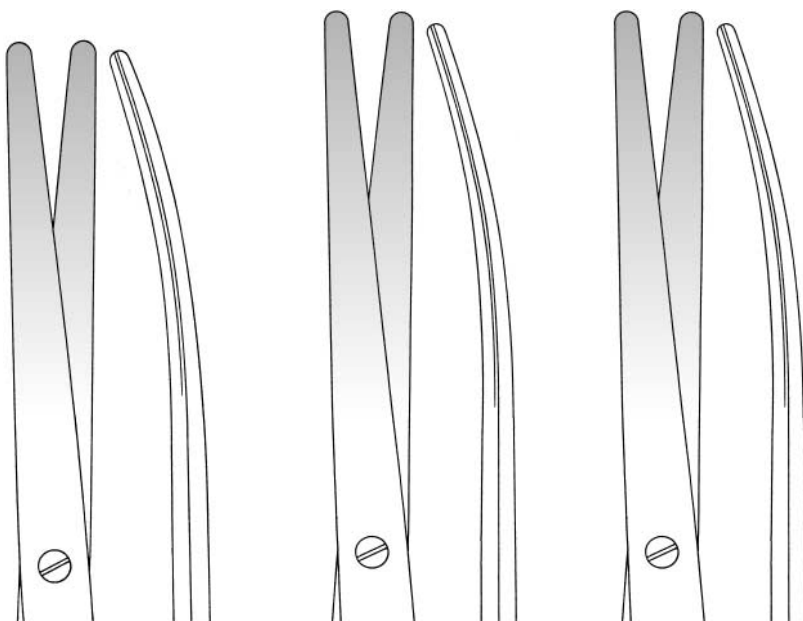

28,5 cm / 11 2/8"

30 cm / 11 6/8"

31 cm / 12 1/8"

## Präparierscheren

Dissecting Scissors  
Tijeras de disección  
Ciseaux à dissection  
Forbici per dissezione

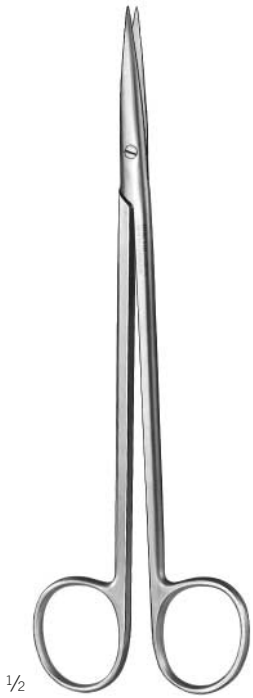

Metzenbaum-Nelson  
11-284-18-07 -  
11-284-20-07

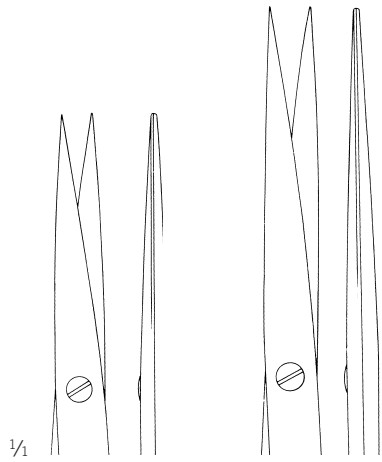

11-284-18-07  
18 cm / 7 1/8"

11-284-20-07  
20,5 cm / 8 1/8"



Metzenbaum  
11-298-14-07-  
11-299-14-07

14,5 cm / 5 7/8"  
eine Schneide gezahnt  
one toothed cutting edge  
una hoja dentada  
une lame dentelée  
una lama dentata

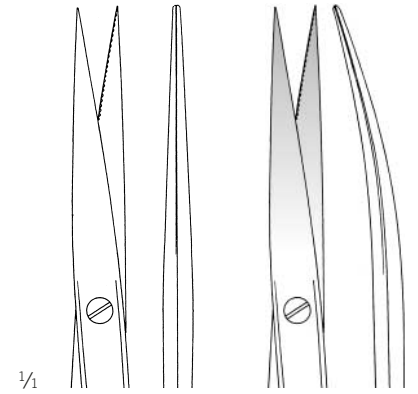

11-298-14-07

11-299-14-07



11-300-15-07 -  
11-301-15-07  
15,5 cm / 6 1/8"

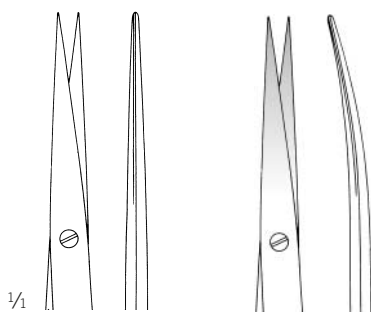

11-300-15-07

11-301-15-07

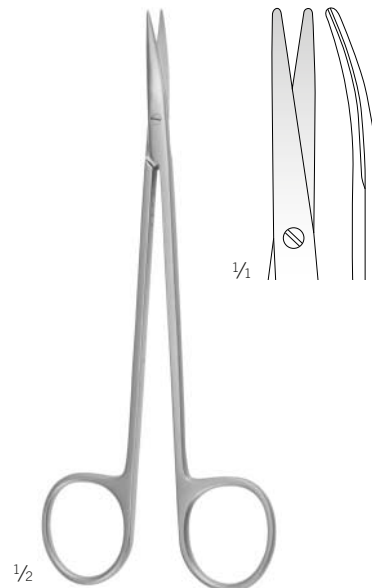

Kübler  
11-302-15-07  
15 cm / 5 7/8"

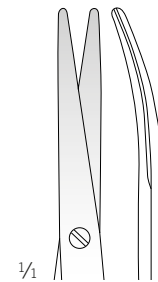

## Präparierscheren

Dissecting Scissors  
Tijeras de disección  
Ciseaux à dissection  
Forbici per dissezione

## Scheren

Scissors  
Tijeras  
Ciseaux  
Forbici



Lexer	Standard	TCGOLD	SuperCut	AQUILA
16 cm / 6 2/8"	11-310-16-07	11-950-16-07	11-662-16-07	28-468-16-07
21 cm / 8 2/8"		11-950-21-07		

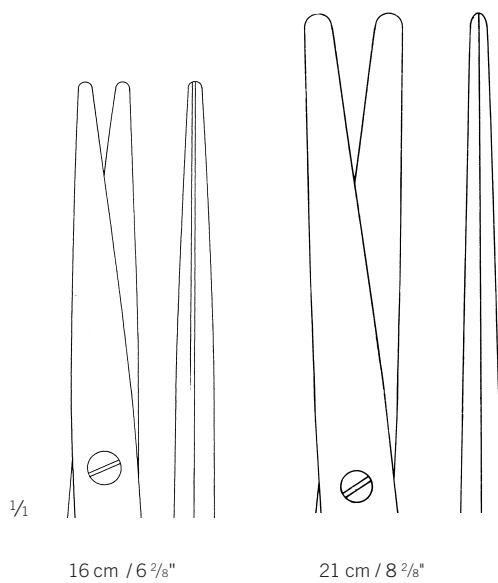

16 cm / 6 2/8"

21 cm / 8 2/8"

# Präparierscheren

Dissecting Scissors  
 Tijeras de disección  
 Ciseaux à dissection  
 Forbici per dissezione



Lexer	Standard	TCGOLD	SuperCut	AQUILA
16 cm / 6 2/8"	11-311-16-07	11-951-16-07	11-663-16-07	28-469-16-07
21 cm / 8 2/8"		11-951-21-07		

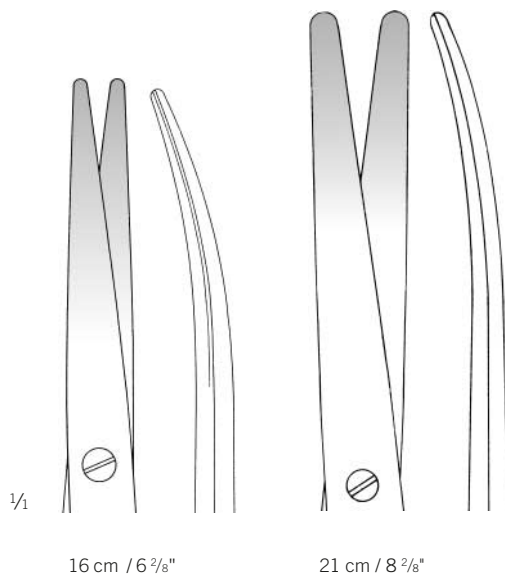

## Präparierscheren

Dissecting Scissors  
Tijeras de disección  
Ciseaux à dissection  
Forbici per dissezione

## Scheren

Scissors  
Tijeras  
Ciseaux  
Forbici



Mayo-Lexer	AQUILA	TCCBlackLine
16 cm / 6 2/8"	11-895-16-07	11-923-16-07



16 cm / 6 2/8"



# Präparierscheren

Dissecting Scissors  
 Tijeras de disección  
 Ciseaux à dissection  
 Forbici per dissezione



Hohenfellner	Standard	TCGOLD
18 cm / 7 1/8"	11-313-18-07	11-314-18-07
21 cm / 8 2/8"	11-313-21-07	11-314-21-07
24 cm / 9 4/8"	11-313-24-07	11-314-24-07

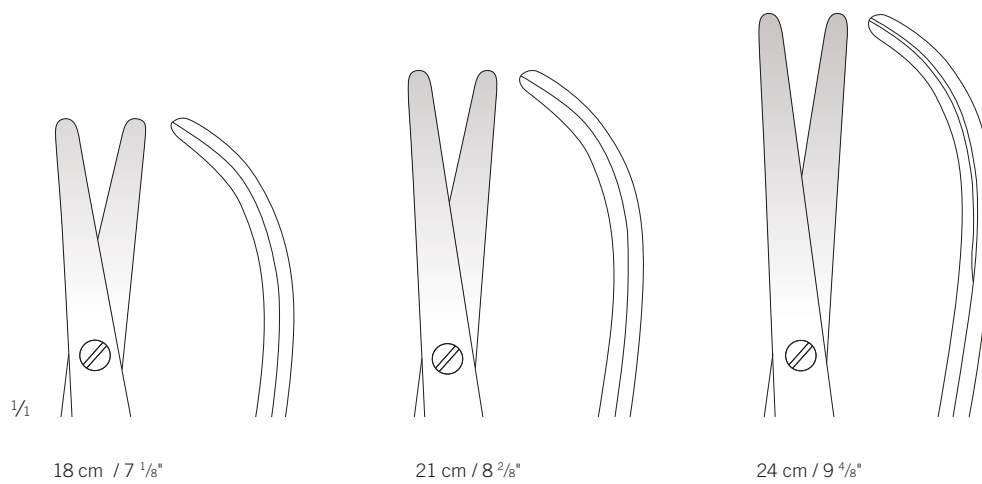

18 cm / 7 1/8"

21 cm / 8 2/8"

24 cm / 9 4/8"

## Präparierscheren

Dissecting Scissors  
Tijeras de disección  
Ciseaux à dissection  
Forbici per dissezione

## Scheren

Scissors  
Tijeras  
Ciseaux  
Forbici



DeBakey	Standard	TCGOLD
17,5 cm / 6 7/8"	11-315-17-07	11-316-17-07
20 cm / 7 7/8"	11-315-20-07	11-316-20-07

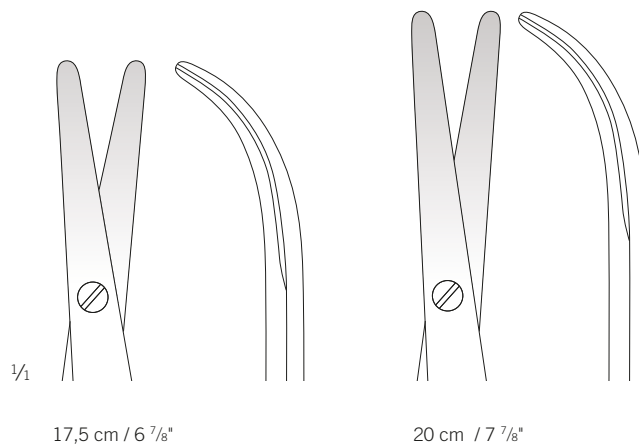

17,5 cm / 6 7/8"

20 cm / 7 7/8"

## Präparierscheren

Dissecting Scissors  
Tijeras de disección  
Ciseaux à dissection  
Forbici per dissezione

---

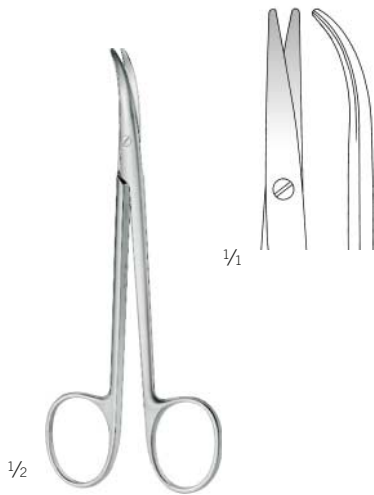

Cinelli  
11-317-11-07  
11,5 cm / 4 5/8"



Fomon  
11-317-14-07  
14 cm / 5 4/8"

## Präparierscheren

Dissecting Scissors  
Tijeras de disección  
Ciseaux à dissection  
Forbici per dissezione

## Scheren

Scissors  
Tijeras  
Ciseaux  
Forbici



Lexer-Baby	Standard	SuperCut
10 cm / 3 7/8"	11-320-10-07	11-662-10-07

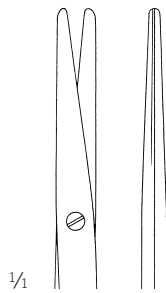

## Präparierscheren

Dissecting Scissors  
Tijeras de disección  
Ciseaux à dissection  
Forbici per dissezione

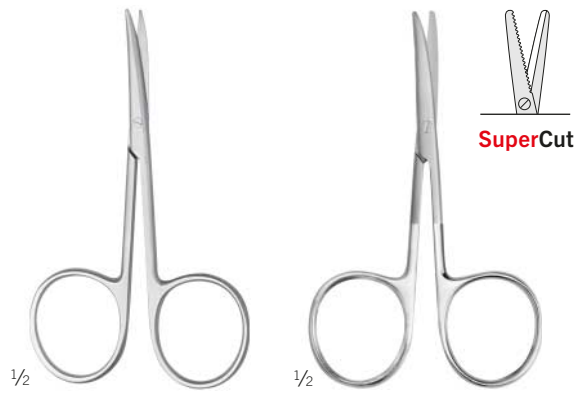

Lexer-Baby	Standard	SuperCut
10 cm / 3 7/8"	11-321-10-07	11-663-10-07

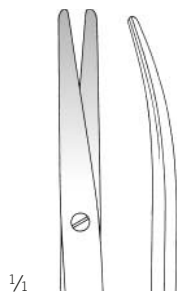

## Präparierscheren

Dissecting Scissors  
Tijeras de disección  
Ciseaux à dissection  
Forbici per dissezione

## Scheren

Scissors  
Tijeras  
Ciseaux  
Forbici



### finoLine



11-324-16-07

11-325-16-07

Lexer-Fino  
11-324-16-07 -  
11-325-16-07

16,5 cm / 6 4/8"  
schlankes Modell  
slender pattern  
modelo delgado  
modèle gracile  
modello delicato

## Feine Präparierscheren

Delicate Dissecting Scissors

Tijeras finas de disección

Ciseaux fins à dissection

Forbici fini per dissezione

**finoLine**



Metzenbaum-Fino	Standard	TCGOLD
14,5 cm / 5 7/8"	11-326-14-07	11-954-14-07
18 cm / 7 1/8"	11-330-18-07	11-960-18-07
20 cm / 7 7/8"	11-330-20-07	
23 cm / 9"	11-330-23-07	

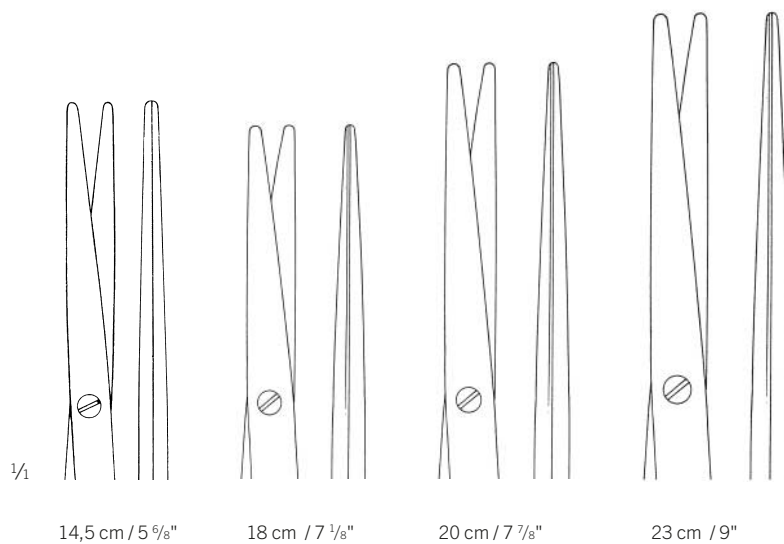

## Feine Präparierscheren

Delicate Dissecting Scissors

Tijeras finas de disección

Ciseaux fins à dissection

Forbici fini per dissezione

## Scheren

Scissors

Tijeras

Ciseaux

Forbici



### finoLine



Metzenbaum-Fino	Standard	TCGOLD	SuperCut	AQUILA
14,5 cm / 5 6/8"	11-327-14-07	11-955-14-07	11-665-14-07	11-889-14-07
18 cm / 7 1/8"	11-331-18-07	11-961-18-07	11-665-18-07	11-889-18-07
20,5 cm / 8 1/8"	11-331-20-07	11-961-20-07	11-665-20-07	
23 cm / 9"	11-331-23-07	11-961-23-07	11-665-23-07	
26 cm / 10 2/8"		11-961-25-07		
28,5 cm / 11 2/8"		11-961-28-07		

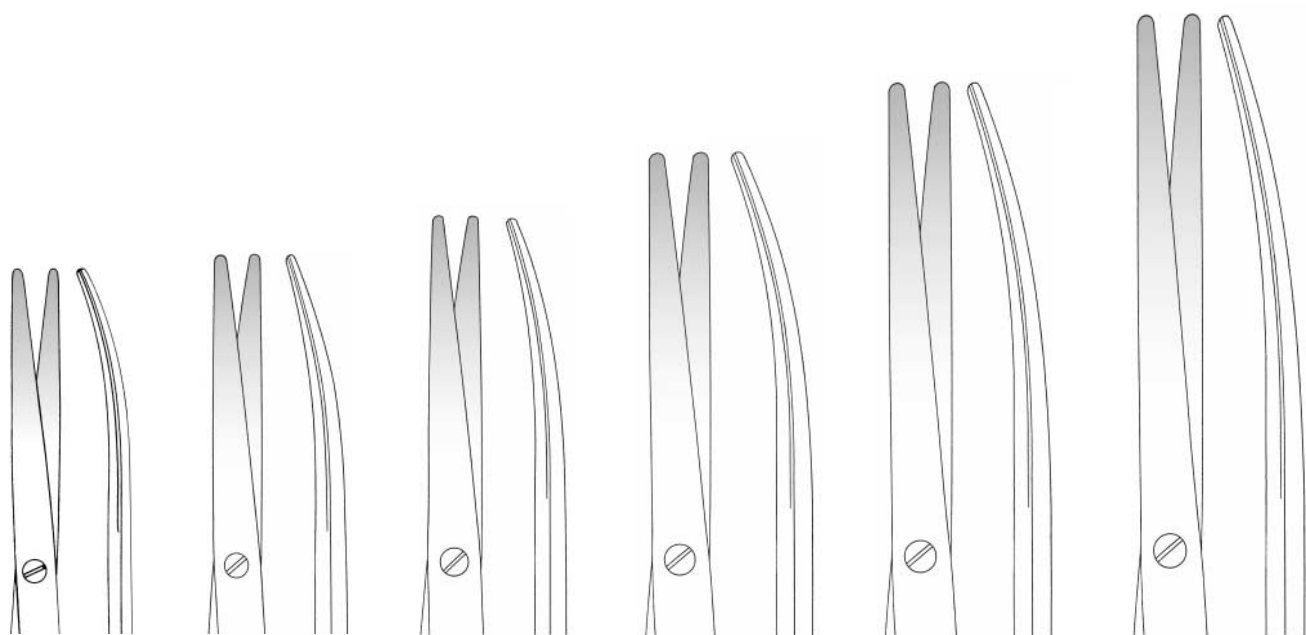

14,5 cm / 5 6/8"

18 cm / 7 1/8"

20,5 cm / 8 1/8"

23 cm / 9"

26 cm / 10 2/8"

28,5 cm / 11 2/8"



## Feine Präparierscheren

Delicate Dissecting Scissors

Tijeras finas de disección

Ciseaux fins à dissection

Forbici fini per dissezione

**finoLine**



Metzenbaum-Fino	Standard	TC <b>GOLD</b>
14,5 cm / 5 7/8"	11-328-14-07	11-956-14-07
18 cm / 7 1/8"		11-962-18-07
20 cm / 7 7/8"		11-962-20-07
23 cm / 9"		11-962-23-07

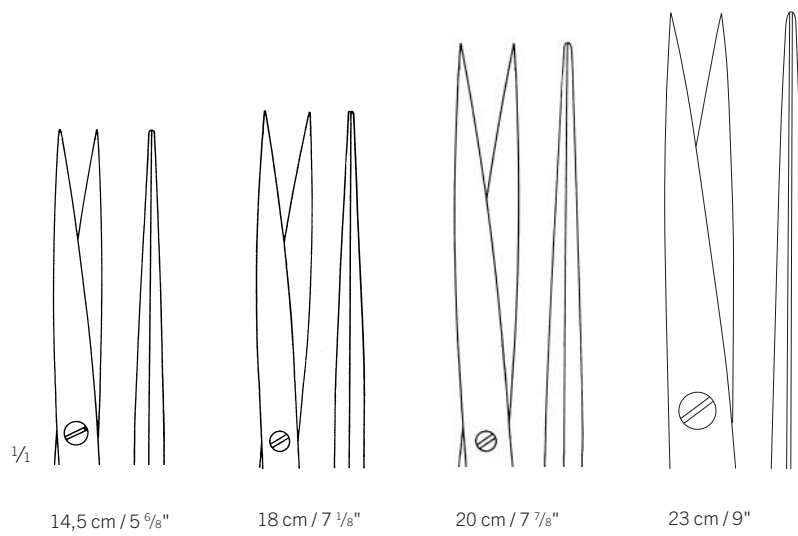

## Feine Präparierscheren

Delicate Dissecting Scissors  
Tijeras finas de disección  
Ciseaux fins à dissection  
Forbici fini per dissezione

## Scheren

Scissors  
Tijeras  
Ciseaux  
Forbici



### finoLine



Metzenbaum-Fino	Standard	TC GOLD
14,5 cm / 5 <sup>6</sup> / <sub>8</sub> "	11-329-14-07	11-957-14-07
18 cm / 7 <sup>1</sup> / <sub>8</sub> "	11-329-18-07	
20 cm / 7 <sup>7</sup> / <sub>8</sub> "	11-329-20-07	

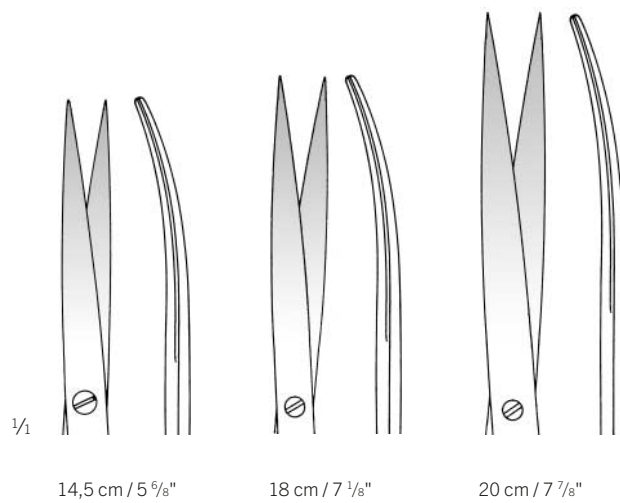

14,5 cm / 5 <sup>6</sup>/<sub>8</sub>"

18 cm / 7 <sup>1</sup>/<sub>8</sub>"

20 cm / 7 <sup>7</sup>/<sub>8</sub>"

# Feine Präparierscheren

Delicate Dissecting Scissors

Tijeras finas de disección

Ciseaux fins à dissection

Forbici fini per dissezione

**finoLine**



Metzenbaum-Fino	Standard	TCGOLD	AQUILA
18 cm / 7 1/8"	11-335-18-07	11-967-18-07	28-473-18-07
20 cm / 7 7/8"			28-473-20-07
20,5 cm / 8 1/8"	11-335-20-07	11-967-20-07	
23 cm / 9"	11-335-23-07	11-967-23-07	28-473-23-07

schlankes Modell, S-Form  
slender pattern, S-shaped  
modelo delgado, forma S  
modèle gracile, courbé en S  
modello delicato, curvo in forma S

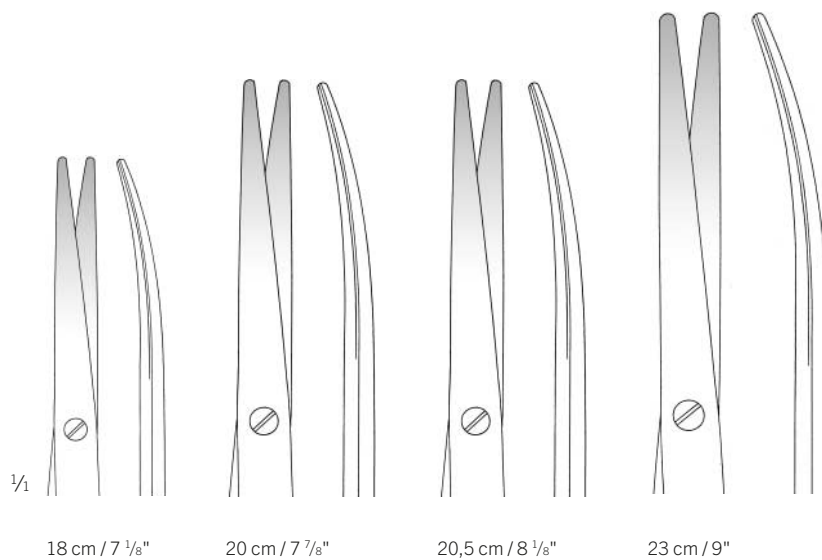

18 cm / 7 1/8"

20 cm / 7 7/8"

20,5 cm / 8 1/8"

23 cm / 9"

# Chirurgische Scheren

Operating Scissors  
Tijeras quirúrgicas  
Ciseaux chirurgicaux  
Forbici per chirurgia

# Scheren

Scissors  
Tijeras  
Ciseaux  
Forbici

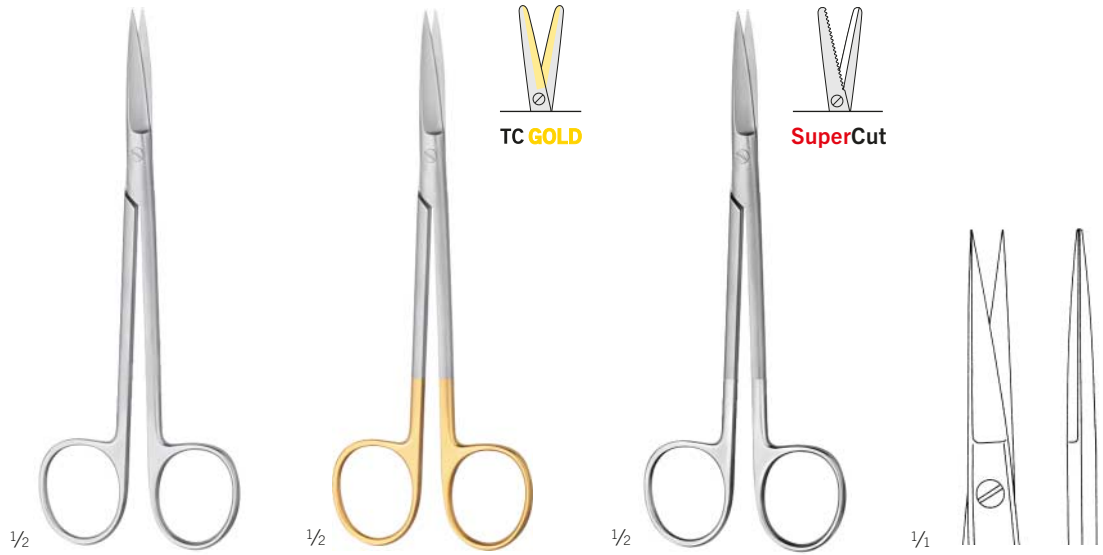

Joseph	Standard	TCGOLD	SuperCut
14,5 cm / 5 6/8"	11-350-14-07	11-948-14-07	11-666-14-07



Joseph	Standard	TCGOLD	SuperCut
14,5 cm / 5 6/8"	11-351-14-07	11-949-14-07	11-667-14-07

## Dissektions- u. Zahnfleischschere

Dissecting Scissors  
Tijera de disección  
Ciseaux à dissection  
Forbici per dissezione



11-358-13-07

13 cm / 5 1/8"

Dissektions- u. Zahnfleischschere  
Dissecting Scissors  
Tijera de disección  
Ciseaux à dissection  
Forbici per dissezione

## Präparierscheren, Gefäßscheren

Dissecting Scissors, Vascular Scissors

Tijeras de disección, Tijeras vasculares

Ciseaux à dissection, Ciseaux vasculaires

Forbici per dissezione, Forbici vascolari

## Scheren

Scissors

Tijeras

Ciseaux

Forbici



Reynolds	Standard
14 cm / 5 4/8"	11-364-14-07
15,5 cm / 6 1/8"	11-364-15-07
18 cm / 7 1/8"	11-364-18-07



14 cm / 5 4/8"

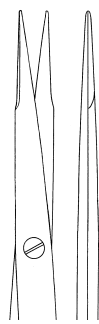

15,5 cm / 6 1/8"



18 cm / 7 1/8"

## Präparierscheren, Gefäßscheren

Dissecting Scissors, Vascular Scissors

Tijeras de disección, Tijeras vasculares

Ciseaux à dissection, Ciseaux vasculaires

Forbici per dissezione, Forbici vascolari



Reynolds	Standard	SuperCut
14 cm / 5 1/8"	11-365-14-07	
15,5 cm / 6 1/8"	11-365-15-07	11-671-15-07
18 cm / 7 1/8"	11-365-18-07	11-671-18-07

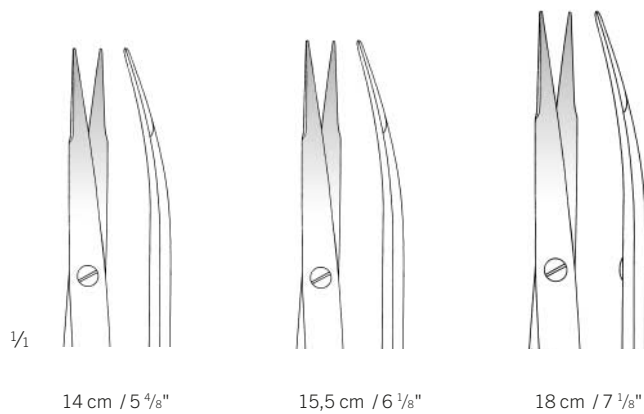

**Präparierscheren, Gefäßscheren**

Dissecting Scissors, Vascular Scissors  
 Tijeras de disección, Tijeras vasculares  
 Ciseaux à dissection, Ciseaux vasculaires  
 Forbici per dissezione, Forbici vascolari

**Scheren**

Scissors  
 Tijeras  
 Ciseaux  
 Forbici



Jameson  
 11-367-14-07  
 15,5 cm / 6 1/8"

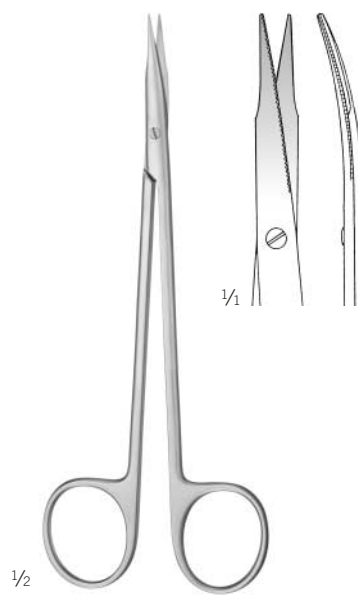

Jameson  
 11-369-14-07  
 15,5 cm / 6 1/8"  
 eine Schneide gezahnt  
 one toothed cutting edge  
 una hoja dentada  
 une lame dentelée  
 una lama dentata

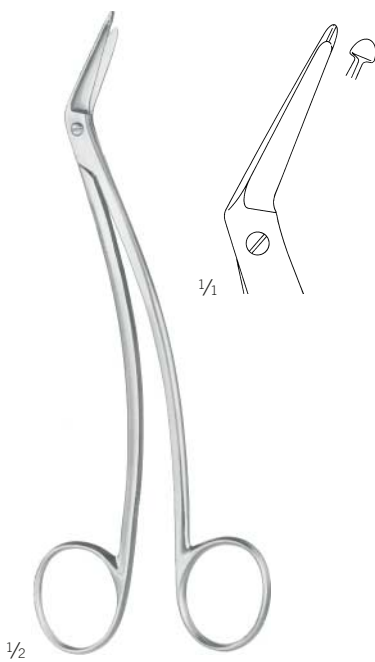

**40°**  
 Schmieden-Taylor  
 11-455-17-07  
 16,5 cm / 6 4/8"



Strully  
 11-445-22-07 - 11-446-22-07  
 22 cm / 8 5/8"  
 Neurochirurgische Schere  
 Neurosurgical scissors  
 Tijeras para neurocirugía  
 Ciseaux pour neurochirurgie  
 Forbici per neurochirurgia



## Feine Präparierscheren

Delicate Dissecting Scissors

Tijeras finas de disección

Ciseaux fins à dissection

Forbici fini per dissezione

### finoLine



Toennis-Adson	Standard	TC <b>GOLD</b>	 <b>AQUILA</b>	<b>TCCBlackLine</b>
17 cm / 6 <sup>5</sup> / <sub>8</sub> "				11-921-17-07
17,5 cm / 6 <sup>7</sup> / <sub>8</sub> "	11-459-17-07	11-965-17-07	11-893-17-07	
18 cm / 7 <sup>1</sup> / <sub>8</sub> "			28-477-18-07	

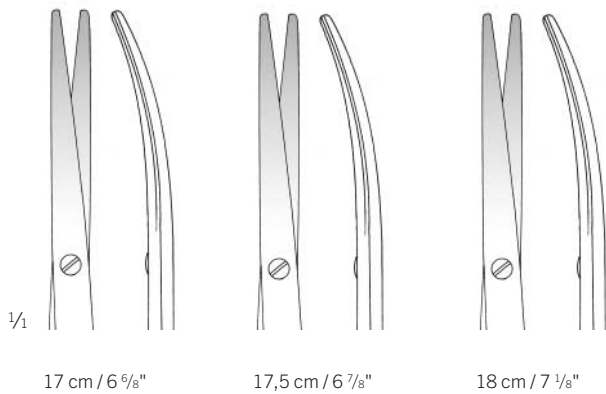

## Präparierscheren

Dissecting Scissors  
Tijeras de disección  
Ciseaux à dissection  
Forbici per dissezione

## Scheren

Scissors  
Tijeras  
Ciseaux  
Forbici



Arbeitslänge  
working length  
largo útil  
longueur utile  
lunghezza utile  
**120 mm**

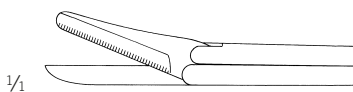

$\frac{1}{2}$

Olivecrona  
11-475-23-07  
13 cm / 5  $\frac{1}{8}$ "

Trigeminusschere  
Trigeminal scissors  
Tijeras para nervio trigémino  
Ciseaux pour le nerf trigéminal  
Forbici per il nervo trigemino  
eine Schneide gezahnt  
one toothed cutting edge  
una hoja dentada  
une lame dentelée  
una lama dentata

## Chirurgische Scheren

Operating Scissors

Tijeras quirúrgicas

Ciseaux chirurgicaux

Forbici per chirurgia

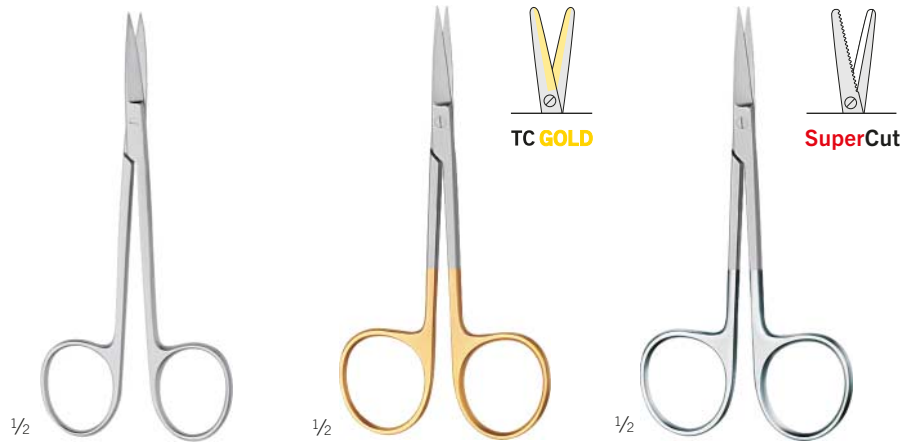

	Standard	TCGOLD	SuperCut
11,5 cm / 4 5/8"	11-630-11-07	11-982-11-07	11-672-11-07



## Chirurgische Scheren

Operating Scissors  
Tijeras quirúrgicas  
Ciseaux chirurgicaux  
Forbici per chirurgia

## Scheren

Scissors  
Tijeras  
Ciseaux  
Forbici



	Standard	TCGOLD	SuperCut
11,5 cm / 4 5/8"	11-631-11-07	11-983-11-07	11-673-11-07

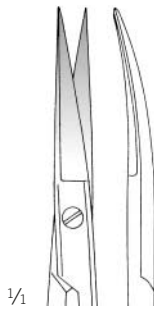

# Irisscheren

Iris Scissors

Tijeras para iridectomía

Ciseaux à iridectomie

Forbici per iridectomia

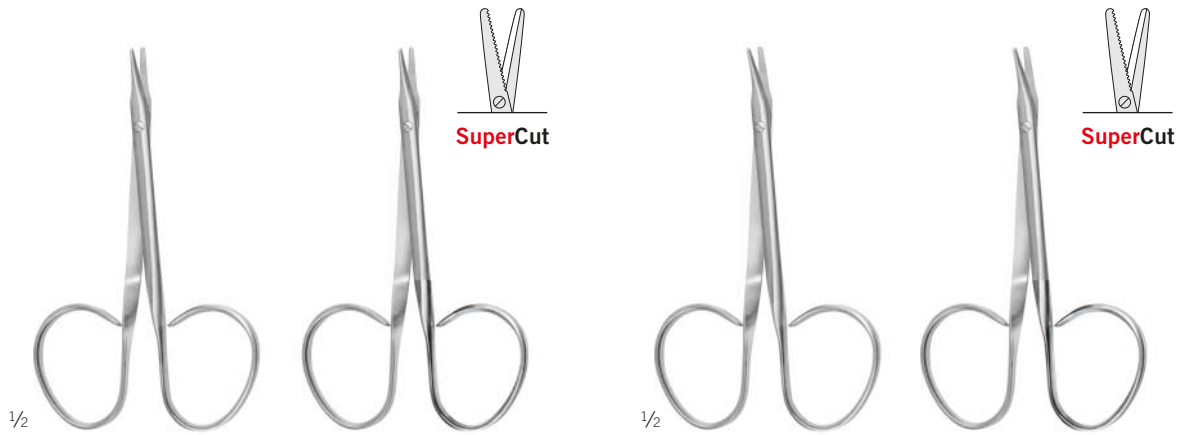

Stevens	Standard	SuperCut
10 cm / 3 7/8"	11-678-10-07	
10,5 cm / 4 1/8"		11-676-10-07
11 cm / 4 3/8"	11-682-11-07	

Standard	SuperCut
11-679-10-07	
	11-677-10-07
11-683-11-07	

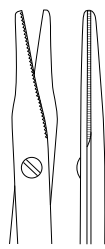
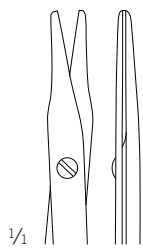

1/1

stumpf/stumpf  
blunt/blunt  
romo/romo  
mousse/mousse  
smusso/smusso

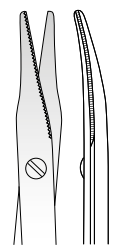
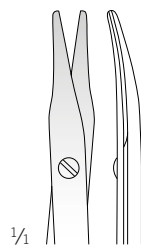

1/1

stumpf/stumpf  
blunt/blunt  
romo/romo  
mousse/mousse  
smusso/smusso

## Irisscheren

Iris Scissors  
Tijeras para iridectomía  
Ciseaux à iridectomie  
Forbici per iridectomia

## Scheren

Scissors  
Tijeras  
Ciseaux  
Forbici

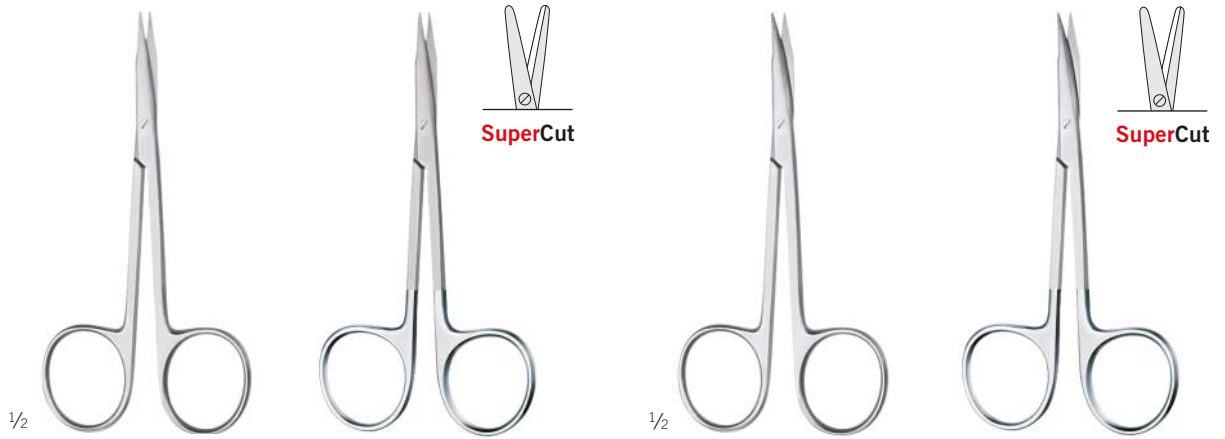

Stevens	Standard	SuperCut
10,5 cm / 4 1/8"		11-674-10-07
11 cm / 4 3/8"	11-680-11-07	

Standard	SuperCut
	11-675-10-07
11-681-11-07	

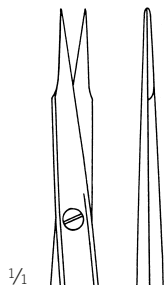

spitz/spitz  
sharp/sharp  
agudo/agudo  
pointu/pointu  
appuntato/appuntato



spitz/spitz  
sharp/sharp  
agudo/agudo  
pointu/pointu  
appuntato/appuntato

## Drahtscheren

Wire Cutting Scissors

Tijeras para cortar hilos de acero

Ciseaux coupe-fil

Forbici per tagliare fili metallici



Universal  
11-865-12-07



Universal  
11-995-12-07

	Standard	TCGOLD	
12 cm / 4 5/8"	11-865-12-07		
12,5 cm / 4 7/8"		11-995-12-07	
	max Ø = 0,4 mm weicher Draht soft wire alambre blando fil métallique souple filo morbido	max Ø = 1,0 mm weicher Draht soft wire alambre blando fil métallique souple filo morbido	max Ø = 0,5 mm harter Draht hard wire alambre duro fil métallique raide filo rigido

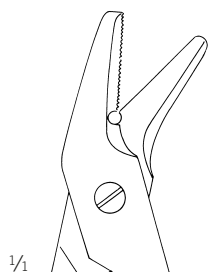

eine Schneide gezahnt  
 one toothed cutting edge  
 una hoja dentada  
 une lame dentelée  
 una lama dentata

## Ligaturscheren

Ligature Scissors  
Tijeras para ligaduras  
Ciseaux pour ligatures  
Forbici per legature

## Scheren

Scissors  
Tijeras  
Ciseaux  
Forbici

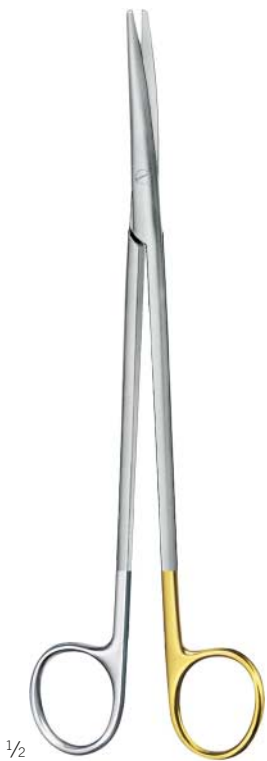
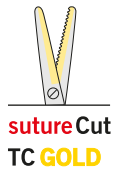

1/2

11-914-14-07 -  
11-914-30-07

für Synthetik-Nahtmaterial,  
eine Schneide gezahnt

for synthetic suture material,  
one toothed cutting edge

para hilos de sutura sintéticos,  
una hoja dentada

pour matériel de suture synthétique,  
une lame dentelée

per materiale di sutura sintetico,  
una lama dentata



1/4

11-914-14-07  
14,5 cm / 5 3/4"



1/4

11-914-18-07  
18 cm / 7"



1/4

11-914-20-07  
20,5 cm / 8"



1/4

11-914-23-07  
23 cm / 9"

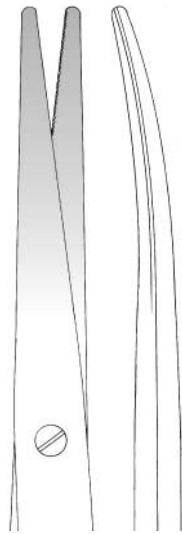

1/4

11-914-25-07  
25 cm / 9 3/4"

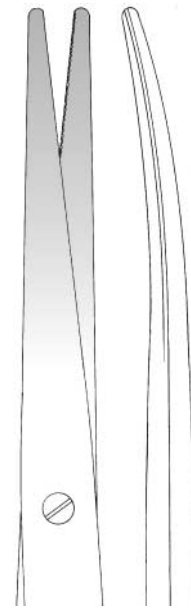

1/4

11-914-30-07  
30 cm / 11 5/8"



## Ligaturscheren

Ligature Scissors

Tijeras para ligaduras

Ciseaux pour ligatures

Forbici per legature

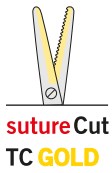

11-915-14-07 -  
11-915-23-07

für Synthetik-Nahtmaterial,  
eine Schneide gezahnt

for synthetic suture material,  
one toothed cutting edge

para hilos de sutura sintéticos,  
una hoja dentada

pour matériel de suture synthétique,  
une lame dentelée

per materiale di sutura sintetico,  
una lama dentata

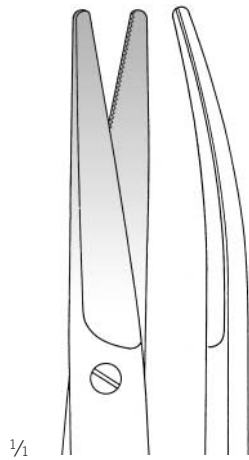

11-915-14-07  
14,5 cm / 5 3/4"

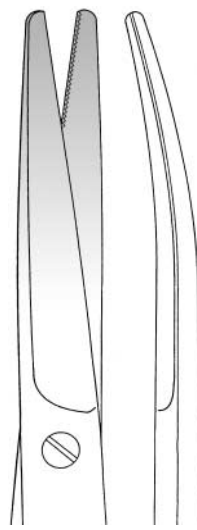

11-915-17-07  
17 cm / 6 3/4"

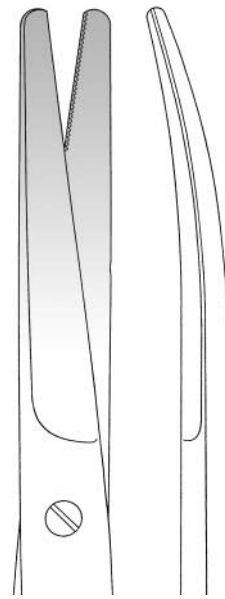

11-915-23-07  
23 cm / 9"

## TCC-BlackLine-Scheren

TCC-BlackLine Scissors

Tijeras TCC-BlackLine

Ciseaux TCC-BlackLine

Forbici TCC-BlackLine

## Scheren

Scissors

Tijeras

Ciseaux

Forbici



TCC BlackLine

finoLine TC GOLD



1/2

11-916-14-07 -  
11-916-20-07

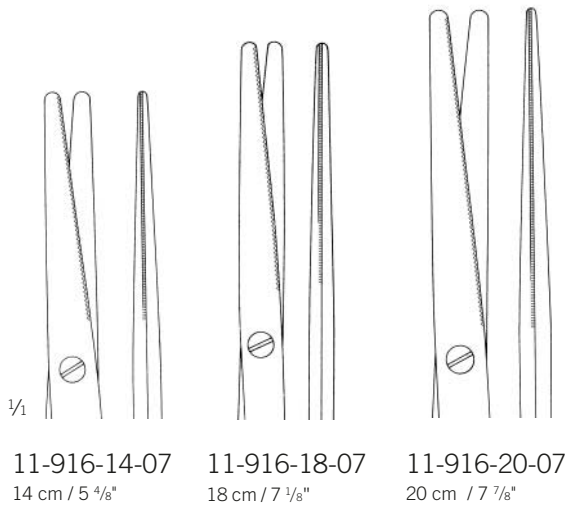

1/1

11-916-14-07  
14 cm / 5 4/8"

11-916-18-07  
18 cm / 7 1/8"

11-916-20-07  
20 cm / 7 7/8"



1/2

Tönnis-Adson TCC-BlackLine  
11-919-14-07 -  
11-919-18-07

sehr fein  
very delicate  
muy fino  
très fin  
strafino

Keramik-Beschichtung,  
eine Schneide gezahnt

Coated with ceramics,  
one toothed cutting edge

Cubierto con material de cerámicas,  
una hoja dentada

Recouvert avec matériau de la  
céramique, une lame dentelée

Ricoprito con materiale di ceramica,  
una lama dentata

## Präparierscheren, Chirurgische Scheren, Feine Präparierscheren

Dissecting Scissors, Operating Scissors, Delicate Dissecting Scissors

Tijeras de disección, Tijeras quirúrgicas, Tijeras finas de disección

Ciseaux à dissection, Ciseaux chirurgicaux, Ciseaux fins à dissection

Forbici per dissezione, Forbici per chirurgia, Forbici fini per dissezione



Knapp  
11-934-12-07 -  
11-935-12-07  
12,5 cm / 4 7/8"

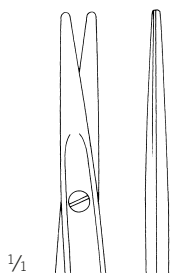

11-934-12-07

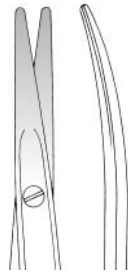

11-935-12-07



Lexer  
11-950-10-07 -  
11-951-10-07  
10 cm / 3 7/8"

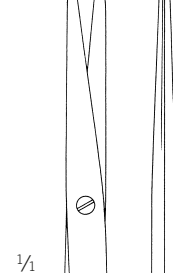

11-950-10-07

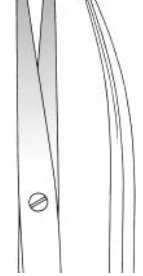

11-951-10-07



Metzenbaum-Lahey  
11-965-14-07  
14,5 cm / 5 6/8"  
schlankes Modell  
slender pattern  
modelo delgado  
modèle gracile  
modello delicato

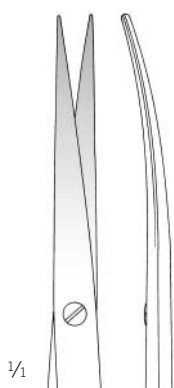

Pinzetten  
Forceps  
Pinzas  
Pincers  
Pinze



## Anatomische Pinzetten

Dissecting Forceps  
Pinzas de disección  
Pincès à dissection  
Pinze per dissezione



1/2

12-100-10-07 -  
12-100-30-07

Standardmodell  
standard pattern  
modelo estándar  
modèle standard  
modello standard

1/1



12-100-10-07  
10,5 cm / 4 1/8"



12-100-11-07  
11,5 cm / 4 5/8"

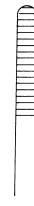

12-100-13-07  
13 cm / 5 1/8"



12-100-14-07  
14,5 cm / 5 7/8"

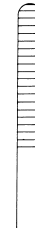

12-100-16-07  
16 cm / 6 2/8"

1/1

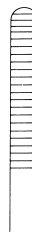

12-100-18-07  
18 cm / 7 1/8"

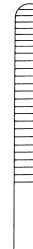

12-100-20-07  
20 cm / 7 7/8"

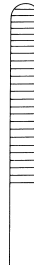

12-100-23-07  
23 cm / 9"

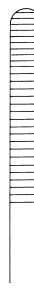

12-100-25-07  
25 cm / 9 7/8"

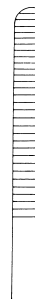

12-100-30-07  
30,5 cm / 12"

1/1



12-120-11-07  
12 cm / 4 5/8"

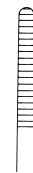

12-120-13-07  
13 cm / 5 1/8"

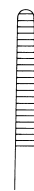

12-120-14-07  
14,5 cm / 5 5/8"

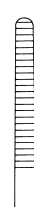

12-120-16-07  
16 cm / 6 2/8"

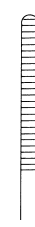

12-120-18-07  
18 cm / 7 1/8"

1/1

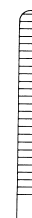

12-120-20-07  
20 cm / 7 7/8"

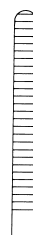

12-120-23-07  
23 cm / 9"



12-120-25-07  
25 cm / 9 7/8"



12-120-30-07  
30 cm / 11 5/8"

1/2

12-120-11-07 -  
12-120-30-07

mittelbreit  
medium width  
de anchura medio  
demi-large  
di media larghezza

# Anatomische Pinzetten

Dissecting Forceps  
 Pinzas de disección  
 Pincès à dissection  
 Pinze per dissezione

# Pinzetten

Forceps  
 Pinzas  
 Pincès  
 Pinze

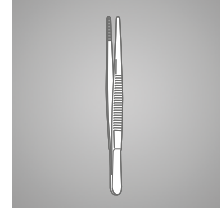

12-122-13-07  
 13 cm / 5 1/8"



12-134-20-07  
 20 cm / 7 7/8"



12-126-13-07 -  
 12-126-14-07



12-126-13-07  
 13 cm / 5 1/8"



12-126-14-07  
 14,5 cm / 5 6/8"



Adson  
 12-168-12-07 -  
 12-168-15-07

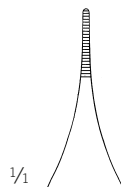

12-168-12-07  
 12 cm / 4 6/8"

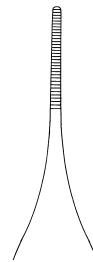

12-168-15-07  
 15 cm / 5 7/8"



12-132-19-07  
 18,5 cm / 7 2/8"



McIndoe  
 12-170-15-07  
 15 cm / 5 7/8"

## Anatomische Pinzetten

Dissecting Forceps  
 Pinzas de disección  
 Pincers à dissection  
 Pinze per dissezione

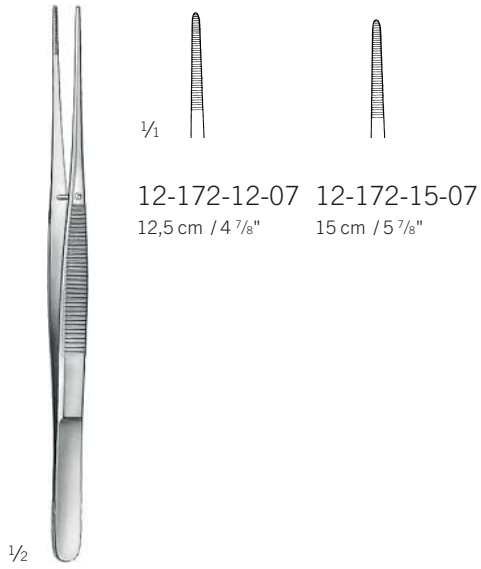

Semken  
 12-172-12-07 - 12-172-15-07

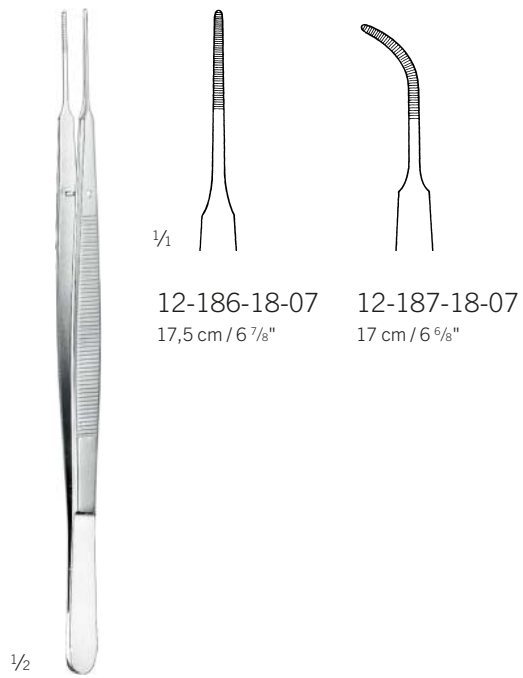

Gerald  
 12-186-18-07 - 12-187-18-07

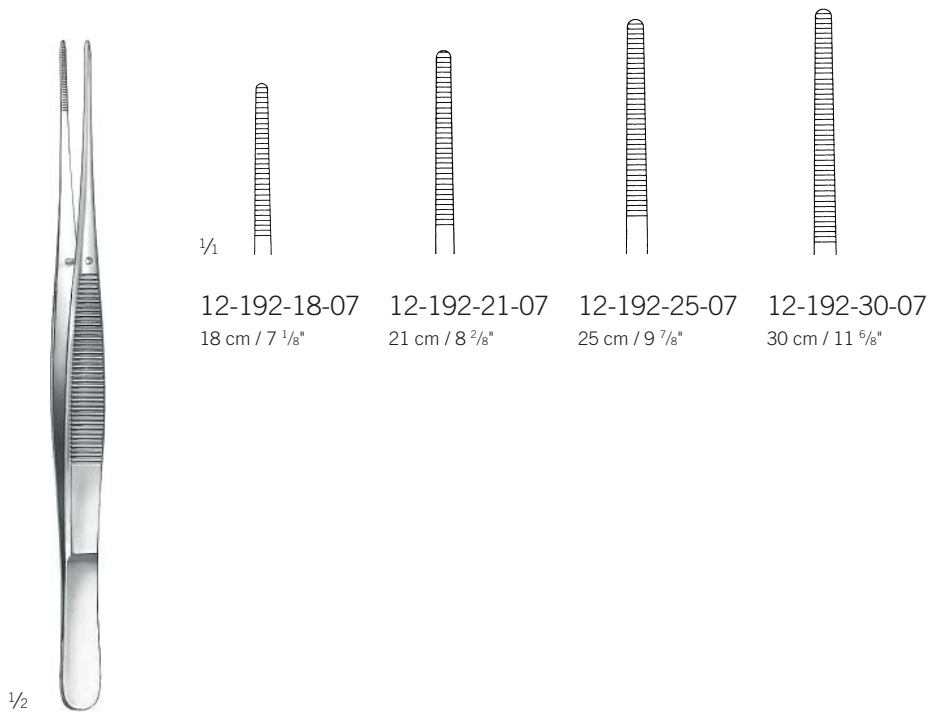

Potts-Smith  
 12-192-18-07 - 12-192-30-07

## Chirurgische Pinzetten, Anatomische Pinzetten

Tissue Forceps, Dissecting Forceps

Pinzas de disección con diente, Pinzas de disección

Pinces à dissection à griffes, Pinces à dissection

Pinze per dissezione con denti, Pinze per dissezione

## Pinzetten

Forceps

Pinzas

Pinces

Pinze

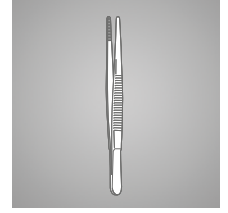

McIndoe  
12-238-15-07

15 cm / 5 7/8"

Miniprofil  
mini profile  
perfil mini  
profil mini  
mini-profilo



1/2

Semken  
12-240-16-07 -  
12-242-18-07

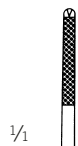

1/4

12-240-16-07

15,5 cm / 6 1/8"

Normalprofil  
normal profile  
perfil normal  
profil normal  
profilo normale



1:2



12-240-18-07

17,5 cm / 6 7/8"

Normalprofil  
normal profile  
perfil normal  
profil normal  
profilo normale



1:2



12-242-16-07

15,5 cm / 6 1/8"

Miniprofil  
mini profile  
perfil mini  
profil mini  
mini-profilo



1:2



12-242-18-07

17,5 cm / 6 7/8"

Miniprofil  
mini profile  
perfil mini  
profil mini  
mini-profilo



1:2



# Chirurgische Pinzetten, Anatomische Pinzetten

Tissue Forceps, Dissecting Forceps

Pinzas de disección con diente, Pinzas de disección

Pinces à dissection à griffes, Pinces à dissection

Pinze per dissezione con denti, Pinze per dissezione

## TC GOLD

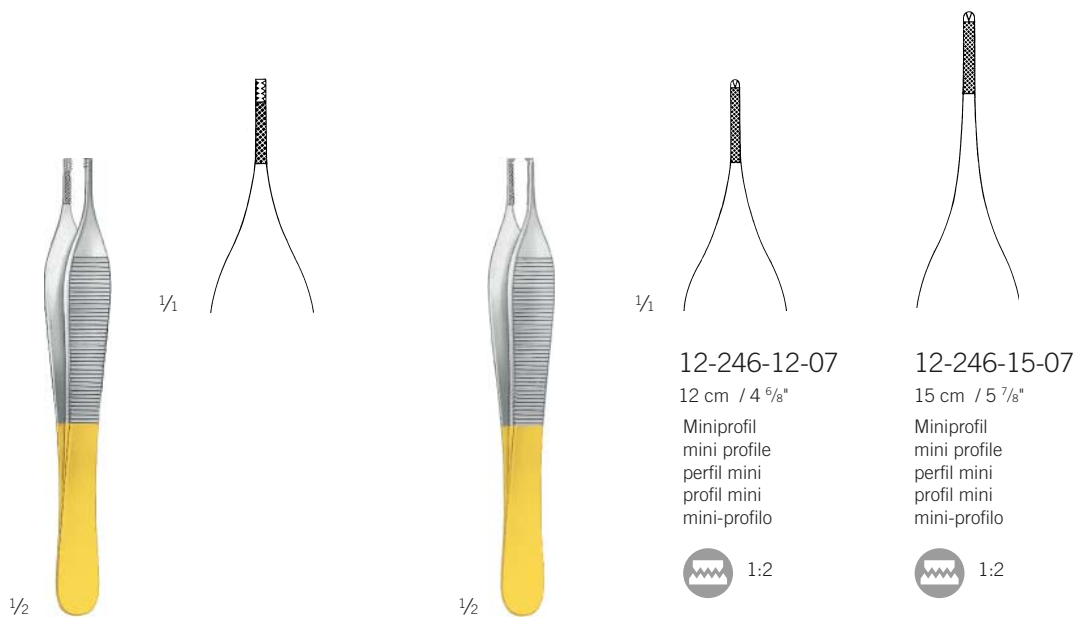

Adson-Brown  
12-244-12-07

12 cm / 4 5/8"

Normalprofil  
normal profile  
perfil normal  
profil normal  
profilo normale

Adson  
12-246-12-07 -  
12-246-15-07

12-246-12-07

12 cm / 4 5/8"

Miniprofil  
mini profile  
perfil mini  
profil mini  
mini-profilo



12-246-15-07

15 cm / 5 7/8"

Miniprofil  
mini profile  
perfil mini  
profil mini  
mini-profilo

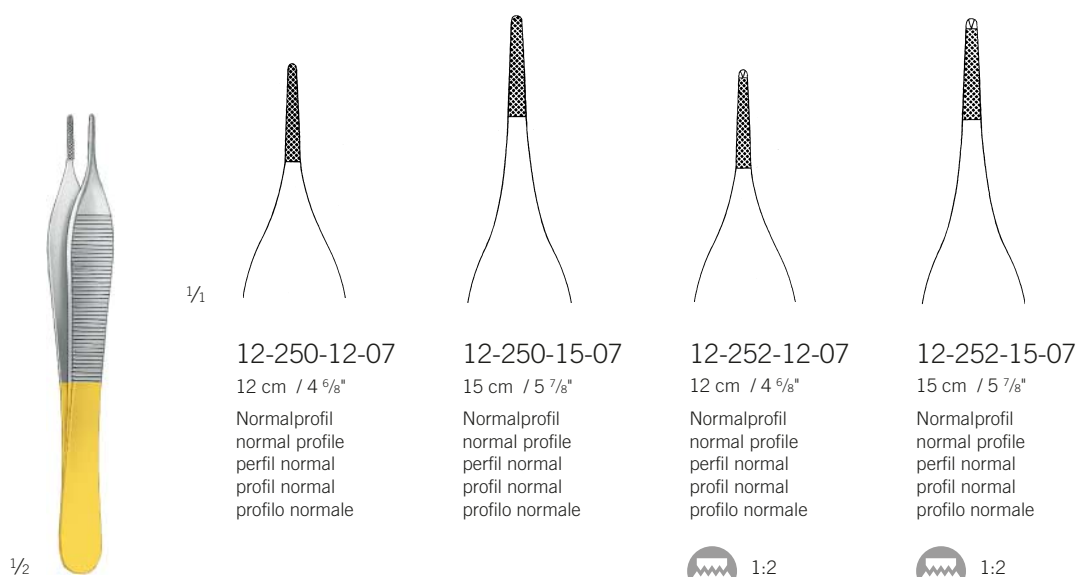

Adson  
12-250-12-07 -  
12-252-15-07

12-250-12-07

12 cm / 4 5/8"

Normalprofil  
normal profile  
perfil normal  
profil normal  
profilo normale

12-250-15-07

15 cm / 5 7/8"

Normalprofil  
normal profile  
perfil normal  
profil normal  
profilo normale

12-252-12-07

12 cm / 4 5/8"

Normalprofil  
normal profile  
perfil normal  
profil normal  
profilo normale

12-252-15-07

15 cm / 5 7/8"

Normalprofil  
normal profile  
perfil normal  
profil normal  
profilo normale



# Anatomische Pinzetten

Dissecting Forceps  
 Pinzas de disección  
 Pincès à dissection  
 Pinze per dissezione

# Pinzetten

Forceps  
 Pinzas  
 Pincès  
 Pinze

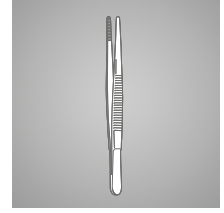

## TC GOLD

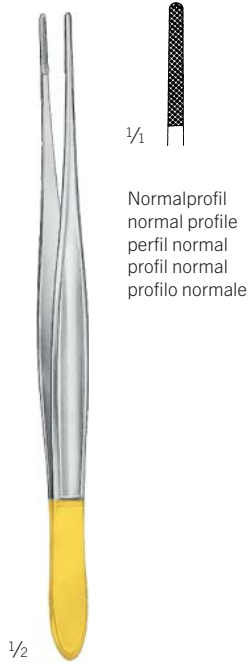

1/1   
 Normalprofil  
 normal profile  
 perfil normal  
 profil normal  
 profilo normale

Cushing  
 12-254-17-07  
 17,5 cm / 6 7/8"



1/1   
 Normalprofil  
 normal profile  
 perfil normal  
 profil normal  
 profilo normale

Cushing  
 12-255-18-07  
 17 cm / 6 5/8"

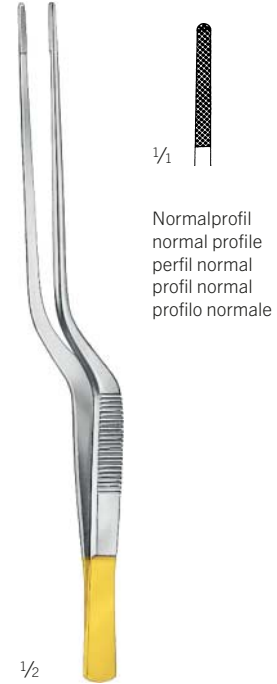

1/1   
 Normalprofil  
 normal profile  
 perfil normal  
 profil normal  
 profilo normale

Cushing-Taylor  
 12-256-18-07  
 18,5 cm / 7 3/8"



1/1   
 12-258-14-07 14 cm / 5 4/8"  
 12-258-18-07 18,5 cm / 7 2/8"  
 12-258-20-07 20 cm / 7 7/8"  
 12-258-23-07 23 cm / 9"  
 12-258-25-07 25 cm / 9 7/8"

Potts-Smith  
 12-258-14-07 - 12-258-25-07

Normalprofil  
 normal profile  
 perfil normal  
 profil normal  
 profilo normale

## Chirurgische Pinzetten

Tissue Forceps

Pinzas de disección con diente

Pinces à dissection à griffes

Pinze per dissezione con denti



1/2

12-301-10-07 -  
12-301-30-07

Standardmodell  
standard pattern  
modelo estándar  
modèle standard  
modello standard

1/4					
	12-301-10-07 10,5 cm / 4 1/8"	12-301-11-07 12 cm / 4 5/8"	12-301-13-07 13 cm / 5 1/8"	12-301-14-07 14,5 cm / 5 5/8"	12-301-16-07 16 cm / 6 2/8"
	1:2	1:2	1:2	1:2	1:2
1/4					
	12-301-18-07 18 cm / 7 1/8"	12-301-20-07 20,5 cm / 8 1/8"	12-301-25-07 25 cm / 9 7/8"	12-301-30-07 30,5 cm / 12"	
	1:2	1:2	1:2	1:2	



1/2

12-302-13-07 -  
12-302-20-07

1/4					
	12-302-13-07 13 cm / 5 1/8"	12-302-14-07 14,5 cm / 5 5/8"	12-302-16-07 16 cm / 6 2/8"	12-302-18-07 18 cm / 7 1/8"	12-302-20-07 20,5 cm / 8 1/8"
	2:3	2:3	2:3	2:3	2:3

# Chirurgische Pinzetten

Tissue Forceps  
 Pinzas de disección con diente  
 Pincès à dissection à griffes  
 Pinze per dissezione con denti

# Pinzetten

Forceps  
 Pinzas  
 Pincès  
 Pinze

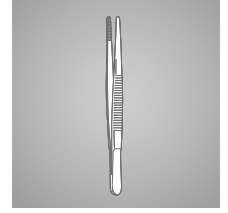

1/2

12-303-14-07  
14,5 cm / 5 7/8"

12-303-16-07  
16 cm / 6 2/8"

12-303-20-07  
20 cm / 7 7/8"

3:4

12-303-14-07 - 12-303-20-07

1/2

12-304-14-07  
14,5 cm / 5 7/8"

12-304-16-07  
16 cm / 6 2/8"

4:5

12-304-14-07 - 12-304-16-07

1/2

12-321-13-07  
13 cm / 5 1/8"

12-321-14-07  
14,5 cm / 5 6/8"

12-321-16-07  
16 cm / 6 2/8"

12-321-18-07  
18 cm / 7 1/8"

12-321-20-07  
20,5 cm / 8 1/8"

1:2

12-323-15-07  
14,5 cm / 5 6/8"

1/2

12-321-13-07 - 12-321-20-07

mittelbreit  
 medium  
 medio  
 moyen  
 medio

12-323-15-07

14,5 cm / 5 6/8"





# Chirurgische Pinzetten

Tissue Forceps  
 Pinzas de disección con diente  
 Pincès à dissection à griffes  
 Pinze per dissezione con denti

# Pinzetten

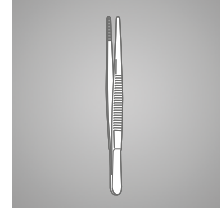
Forceps  
 Pinzas  
 Pincès  
 Pinze

1/2

Potts-Smith  
 12-392-18-07 -  
 12-392-30-07

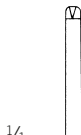

1/1

12-392-18-07  
 18 cm / 7 1/8"

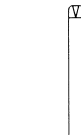

12-392-21-07  
 21 cm / 8 2/8"

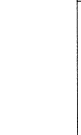

12-392-25-07  
 25 cm / 9 7/8"



1:2



1:2



1:2



1/2

Adson-Brown  
 12-400-12-07  
 12 cm / 4 6/8"



1/1



7:7



1/2

Mikro-Adson  
 12-404-12-07 - 12-404-15-07



1/1

12-404-12-07  
 12 cm / 4 6/8"



12-404-15-07  
 15 cm / 5 7/8"



1/2

Mikro-Adson  
 12-406-12-07 - 12-406-15-07



1/1

12-406-12-07  
 12 cm / 4 6/8"



12-406-15-07  
 15 cm / 5 7/8"



1:2



1:2

## Gefäßpinzetten

Vascular Forceps

Pinzas de disección vascular

Pinces à dissection vasculaires

Pinze per dissezione vascolari

**Atrauma**



<b>1,5 mm</b>	<b>1,5 mm</b>	<b>1,5 mm</b>
24-386-16-07	24-386-20-07	24-386-24-07
16 cm / 6 2/8"	20 cm / 7 7/8"	25 cm / 9 7/8"



<b>2,0 mm</b>	<b>2,0 mm</b>	<b>2,0 mm</b>	<b>2,0 mm</b>
24-388-16-07	24-388-20-07	24-388-24-07	24-388-30-07
16 cm / 6 2/8"	20 cm / 7 7/8"	25 cm / 9 7/8"	30 cm / 11 6/8"

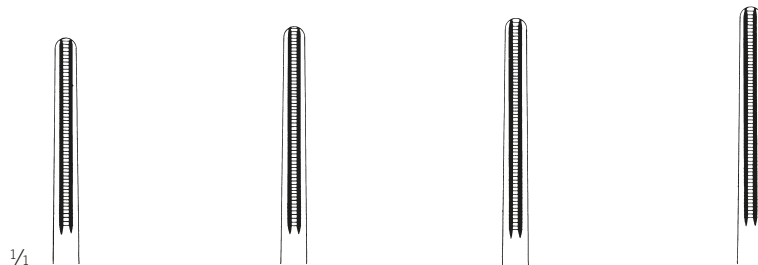

<b>2,7 mm</b>	<b>2,7 mm</b>	<b>2,7 mm</b>	<b>2,7 mm</b>
24-384-16-07	24-384-20-07	24-384-24-07	24-384-30-07
16 cm / 6 2/8"	20 cm / 7 7/8"	25 cm / 9 7/8"	30 cm / 11 6/8"

1/2



De Bakey  
24-384-16-07 -  
24-390-30-07

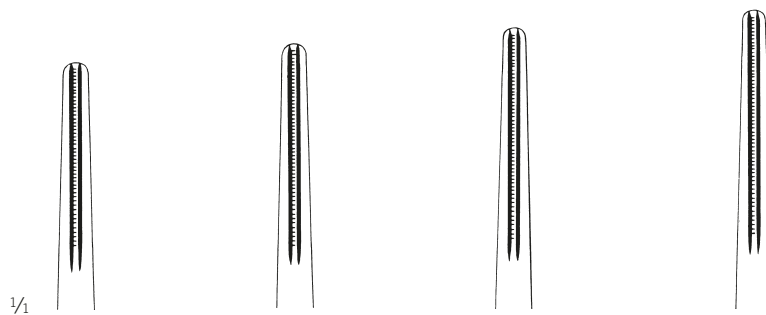

<b>3,5 mm</b>	<b>3,5 mm</b>	<b>3,5 mm</b>	<b>3,5 mm</b>
24-390-16-07	24-390-20-07	24-390-24-07	24-390-30-07
16 cm / 6 2/8"	20 cm / 7 7/8"	25 cm / 9 7/8"	30 cm / 11 6/8"

## Gefäßpinzetten

Vascular Forceps  
Pinzas de disección vascular  
Pincès à dissection vasculaires  
Pinze per dissezione vascolari

## Pinzetten

Forceps  
Pinzas  
Pincès  
Pinze

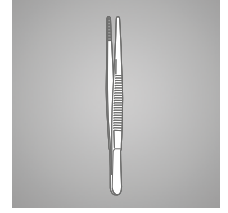

**Atrauma**



1/2

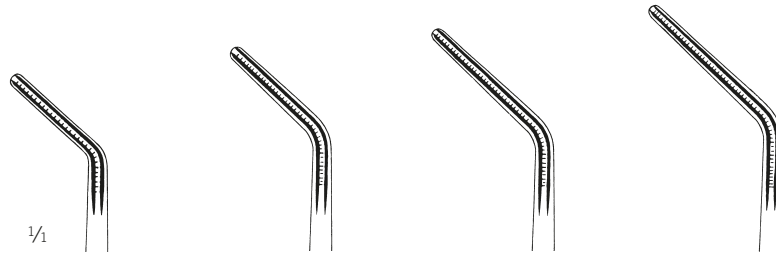

2,0 mm	2,0 mm	2,0 mm	2,0 mm
24-389-16-07	24-389-20-07	24-389-24-07	24-389-30-07
16 cm / 6 2/8"	20 cm / 7 7/8"	25 cm / 9 7/8"	30 cm / 11 6/8"

De Bakey  
24-389-16-07 -  
24-389-30-07

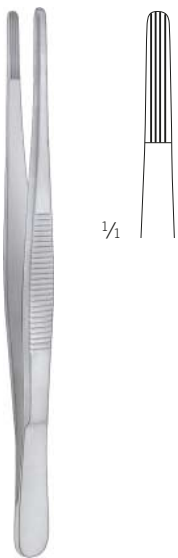

1/2

Ochsner  
20-894-14-07

14,5 cm / 5 6/8"  
Fadenpinzette  
Thread forceps  
Pinzas para ligaduras  
Pince à fil  
Pinze porta-filo



## Pinzetten, bajonett

Forceps, bayonet  
Pinzas, bayoneta  
Pinces, baïonnette  
Pinze, baionetta



Grünwald  
36-391-14-07  
14,5 cm / 5 <sup>6</sup>/<sub>8</sub>"  
Ohrpinzetten  
Ear forceps  
Pinzas auriculares  
Pinces auriculaires  
Pinze auricolari

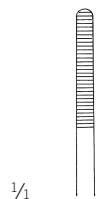

36-395-16-07  
16 cm / 6 <sup>2</sup>/<sub>8</sub>"



36-395-20-07  
21,5 cm / 8 <sup>4</sup>/<sub>8</sub>"

Jansen  
36-395-16-07 -  
36-395-20-07



Grünwald (Jansen)  
37-115-16-07 - 37-115-20-07  
Nasentamponpinzette  
Nasal tampon forceps  
Pinzas para tampones nasales  
Pince pour pansements nasales  
Pinze per tamponi nasali



37-115-16-07  
16 cm / 6 <sup>2</sup>/<sub>8</sub>"

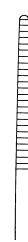

37-115-20-07  
21,5 cm / 8 <sup>4</sup>/<sub>8</sub>"

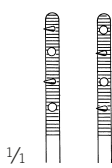

1,7 mm

Cottle  
37-731-14-07  
14 cm / 5 <sup>4</sup>/<sub>8</sub>"

Hautfasspinzette, mit Zähnen  
Skin grasping forceps, with teeth  
Pinzas para piel, con dientes  
Pinces pour saisir la peau, avec dents  
Pinze per afferrare la pelle, con denti

Klemmen  
Forceps  
Pinzas  
Pincers  
Pinze

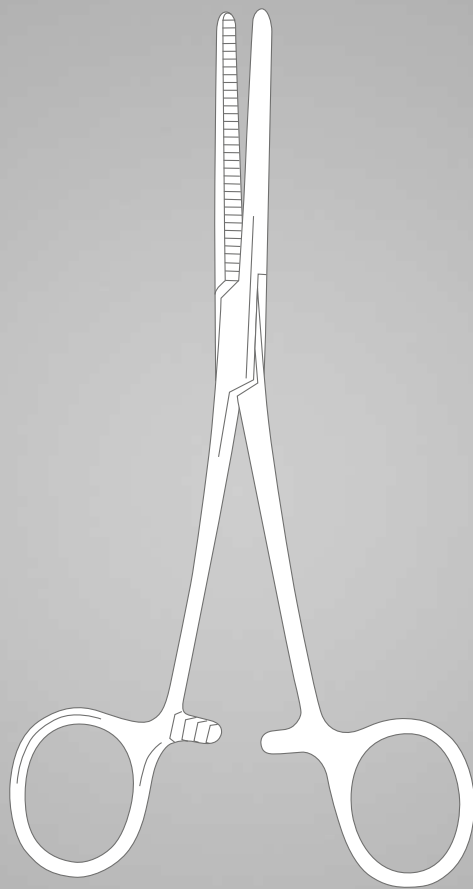

## Clip-Anlegepinzette, Gefäßclips

Clip Applying Forceps, Vessel Clips

Pinzas para aplicar clips,

Pinces pour poser les clips vasculaires, Clips vasculaires

Pinze per applicazione clips vascolari,



Biemer  
13-010-00-07

16 cm / 6 2/8"

Gefäßspreizer  
Vascular spreader  
Dilatador de vasos  
Ecarteur vasculaire  
Dilatatore vascolare



13-050-14-07

14,5 cm / 5 5/8"

ohne Sperre  
w/o ratchet  
sin cremallera  
sans cremaillère  
senza cremagliera

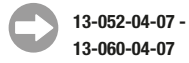

13-051-14-07

14,5 cm / 5 5/8"

mit Sperre  
with ratchet  
con cremallera  
avec cremaillère  
con cremagliera

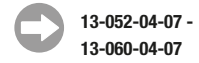

Biemer  
13-052-04-07 -  
13-053-05-07



St	13-052-04-07	13-052-05-07	13-053-05-07
	14 mm	17 mm	17 mm
	6 mm	9 mm	9 mm
	4 mm	7 mm	7 mm
P	30 - 40 g	30 - 40 g	20 - 25 g

## Gefäßclips, Approximatoren

Vessel Clips, Approximators  
Clips vasculares, Aproximadores  
Clips vasculaires, Approximateurs  
Clip vascolari, Approssimatori

## Klemmen

Forceps  
Pinzas  
Pincers  
Pinze



1/1

Biemer-Müller  
13-054-05-07 -  
13-059-05-07



1/1

	gerade, breit straight, wide recto, ancho droit, large retto, largo	gewinkelt, breit angled, wide angulado, ancho coudé, large angulato, largo	gerade, schmal straight, narrow recto, estrecho droit, étroit retto, stretto	gerade, schmal straight, narrow recto, estrecho droit, étroit retto, stretto	gewinkelt, schmal angled, narrow angulado, estrecho coudé, étroit angulato, stretto
St	13-054-05-07	13-055-05-07	13-056-03-07	13-058-05-07	13-059-05-07
	17 mm	17 mm	13 mm	17 mm	17 mm
	9 mm	9 mm	4,5 mm	9 mm	9 mm
	7 mm	7 mm	4 mm	7 mm	7 mm
P	30 - 40 g	30 - 40 g	30 - 40 g	30 - 40 g	25 - 30 g

## Approximatoren, Nerv-Approximatoren

Approximators, Nerve Approximators

Aproximadores, Aproximadores para nervios

Approximateurs, Approximateurs pour nerfs

Approssimatori, Approssimatori per nervi

für Mikro-Gefäßanastomosen in der Tiefe  
for Micro vessel anastomosis in the depth  
para micro anastomosis en la profundidad  
pour micro-anastomoses vasculaires en profondeur  
per micro-anastomosi vascolari nella profondità

1/1



13-062-00-07

komplett mit Schlüssel  
complete with key  
completo con llave  
complet avec clef  
completti con chiave

1/1



1/1



13-062-01-07

Schlüssel für Approximator  
Key for Approximator  
Llave para aproximador  
Clef pour approximateur  
Chiave per approssimatore



13-062-02-07 & 13-063-02-07

1/1



13-062-02-07

Approximator, allein  
Approximator, only  
Aproximador, suelto  
Approximateur, seul  
Approssimatore, solo

## Mini-Gefäßclips, Clip-Anlegezangen, Bulldogklemmen

Mini Vessel Clips, Clip Applying Forceps

Mini Clips vasculaires, Pinzas para aplicar clips

Micro-clips vasculaires, Pincers pour poser micro-clips

Mini-clip vascolari, Pinze per applicare clips vascolari

## Klemmen

Forceps

Pinzas

Pincers

Pinze



1/1

13-102-04-07 -  
13-102-10-07

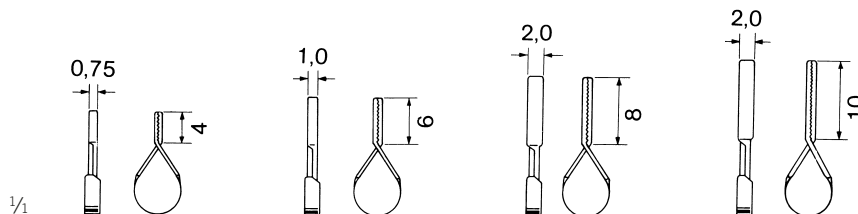

St	13-102-04-07	13-102-06-07	13-102-08-07	13-102-10-07
	13 mm	15 mm	17 mm	20 mm
	4 mm	6 mm	8 mm	10 mm
	4 mm	5 mm	6 mm	7 mm
P	60 g	85 g	100 g	125 g



1/2

13-104-14-07

14,5 cm / 5 7/8"

mit Sperre  
with ratchet  
con cremallera  
avec cremaillère  
con cremagliera

➔ 13-102-04-07 -  
13-102-10-07



1/2

13-106-18-07

18,5 cm / 7 2/8"

mit Sperre  
with ratchet  
con cremallera  
avec cremaillère  
con cremagliera

➔ 13-102-04-07 -  
13-102-10-07

## Arterienklemmen

Haemostatic Forceps  
Pinzas hemostáticas  
Pincas hémostatiques  
Pinze emostatiche



1/2

13-303-01-07

13,5 cm / 5 3/8"

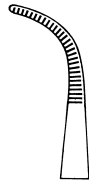

13-303-02-07

13 cm / 5 1/8"

Mixer-Baby  
13-303-01-07 -  
13-303-02-07



1/2

Mikro-Adson  
13-304-14-07

14 cm / 5 4/8"

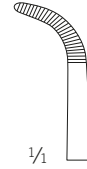

1/1



1/2

Baby-Adson  
13-305-18-07

18 cm / 7 1/8"

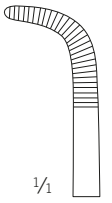

1/1



1/2

Halsted-Mosquito  
13-310-12-07 -  
13-313-14-07

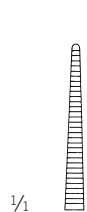

1/1

13-310-12-07

12,5 cm / 4 7/8"



13-310-14-07

14,5 cm / 5 6/8"



13-311-12-07

12 cm / 4 6/8"



13-311-14-07

14 cm / 5 4/8"

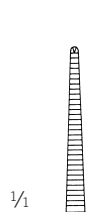

1/1

13-312-12-07

12,5 cm / 4 7/8"



13-312-14-07

14,5 cm / 5 6/8"



13-313-12-07

12,5 cm / 4 7/8"



13-313-14-07

14,5 cm / 5 6/8"



1:2



1:2



1:2



1:2

## Arterienklemmen

Haemostatic Forceps  
Pinzas hemostáticas  
Pincas hémostatiques  
Pinze emostatiche

## Klemmen

Forceps  
Pinzas  
Pincas  
Pinze



1/2

Halsted-Mosquito  
13-316-18-07 -  
13-319-21-07

1/4



13-316-18-07  
18,5 cm / 7 2/8"



13-316-21-07  
21 cm / 8 2/8"

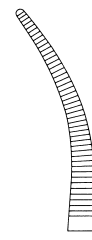

13-317-18-07  
18 cm / 7 1/8"

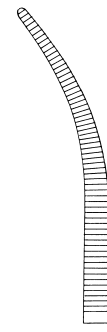

13-317-21-07  
20,5 cm / 8 1/8"

1/4



13-318-18-07  
18,5 cm / 7 2/8"



13-318-21-07  
21 cm / 8 2/8"



13-319-18-07  
18 cm / 7 1/8"

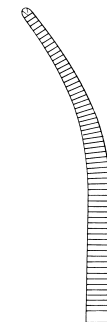

13-319-21-07  
20,5 cm / 8 1/8"



1:2



1:2



1:2



1:2



## Arterienklemmen

Haemostatic Forceps  
Pinzas hemostáticas  
Pincas hémostatiques  
Pinze emostatiche



Providence-Hospital  
13-324-14-07 -  
13-325-14-07

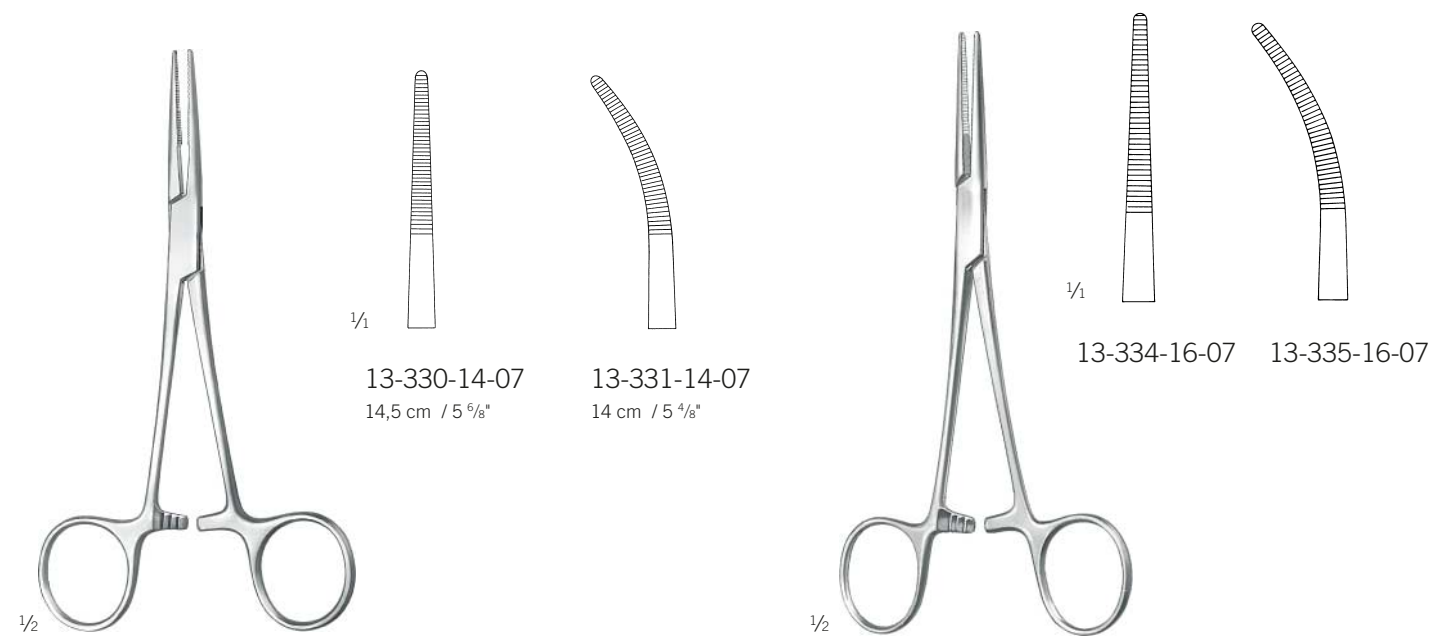

Kelly  
13-330-14-07 -  
13-331-14-09

Kelly-Rankin  
13-334-16-07 -  
13-335-16-07  
16 cm / 6 2/8"

## Arterienklemmen

Haemostatic Forceps  
Pinzas hemostáticas  
Pincès hémostatiques  
Pinze emostatiche

## Klemmen

Forceps  
Pinzas  
Pincès  
Pinze



1/2

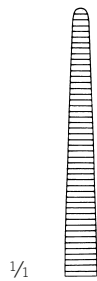

1/4

13-340-14-07



13-341-14-07



13-342-14-07



13-343-14-07



1:2



1:2

Crile  
13-340-14-07 -  
13-343-14-07

14,5 cm / 5 7/8"



1/2

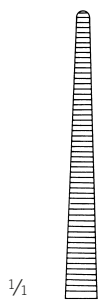

1/4

13-346-16-07

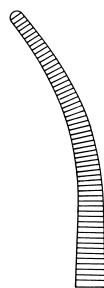

13-347-16-07

Crile-Rankin  
13-346-16-07 -  
13-347-16-07

16 cm / 6 2/8"



1/2

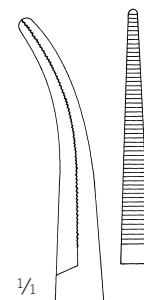

1/4

13-355-14-07

14,5 cm / 5 6/8"

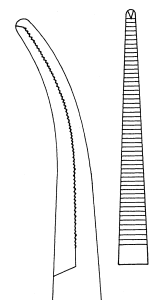

13-357-14-07

14 cm / 5 4/8"



1:2

Dandy  
13-355-14-07 -  
13-357-14-07

seitlich gebogen  
laterally curved  
curva lateralmente  
courbe lateralement  
curva laterale

## Arterienklemmen

Haemostatic Forceps  
Pinzas hemostáticas  
Pincers hémostatiques  
Pinze emostatiche



1/2

Pean  
13-374-13-07 -  
13-375-16-07

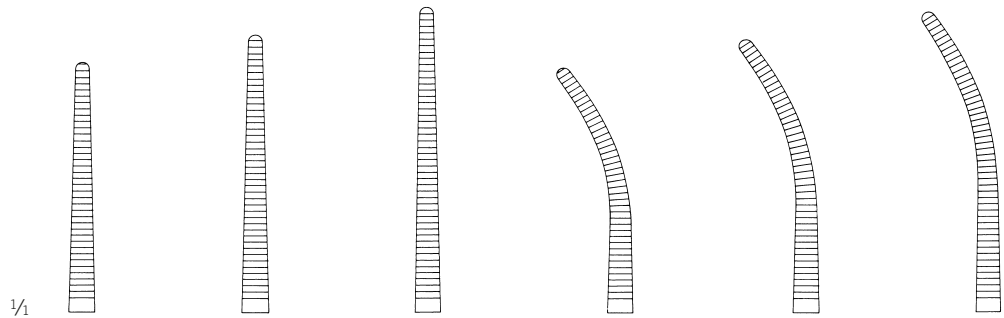

13-374-13-07  
13,5 cm / 5 3/8"

13-374-14-07  
14,5 cm / 5 7/8"

13-374-16-07  
17 cm / 6 5/8"

13-375-13-07  
13 cm / 5 1/8"

13-375-14-07  
14 cm / 5 4/8"

13-375-16-07  
16,5 cm / 6 4/8"



1/2

Kocher  
13-384-13-07 -  
13-385-16-07

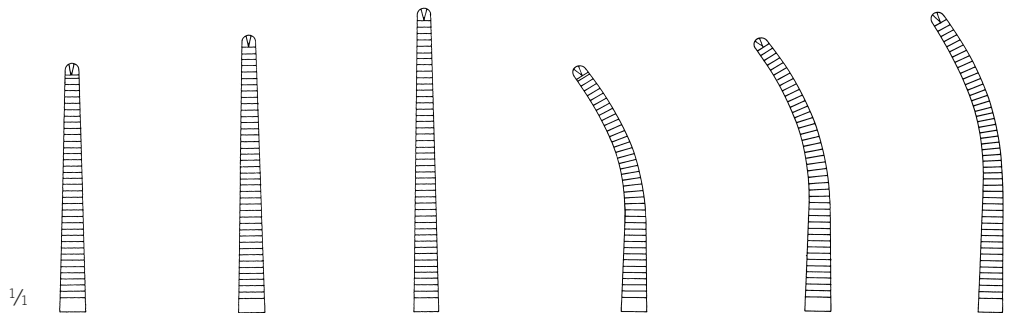

13-384-13-07  
13 cm / 5 1/8"

13-384-14-07  
14 cm / 5 4/8"

13-384-16-07  
16 cm / 6 2/8"

13-385-13-07  
13 cm / 5 1/8"

13-385-14-07  
14 cm / 5 4/8"

13-385-16-07  
16 cm / 6 2/8"



## Arterienklemmen

Haemostatic Forceps  
Pinzas hemostáticas  
Pincès hémostatiques  
Pinze emostatiche

## Klemmen

Forceps  
Pinzas  
Pincès  
Pinze

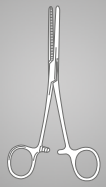

1/1



13-410-14-07  
14,5 cm / 5 7/8"



13-410-16-07  
16,5 cm / 6 4/8"

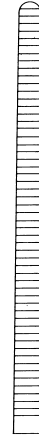

13-410-18-07  
18,5 cm / 7 2/8"



13-410-20-07  
20,5 cm / 8 1/8"

1/1

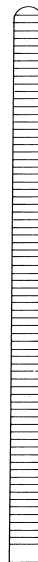

13-410-22-07  
22,5 cm / 8 7/8"

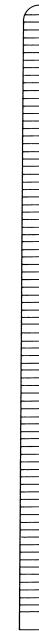

13-410-24-07  
24 cm / 9 4/8"

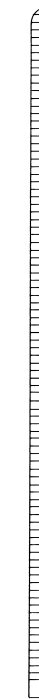

13-410-26-07  
26 cm / 10 2/8"

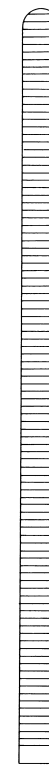

13-410-30-07  
31 cm / 12 2/8"

1/2



Pean (Rochester)  
13-410-14-07 -  
13-410-30-07

## Arterienklemmen

Haemostatic Forceps

Pinzas hemostáticas

Pinces hémostatiques

Pinze emostatiche

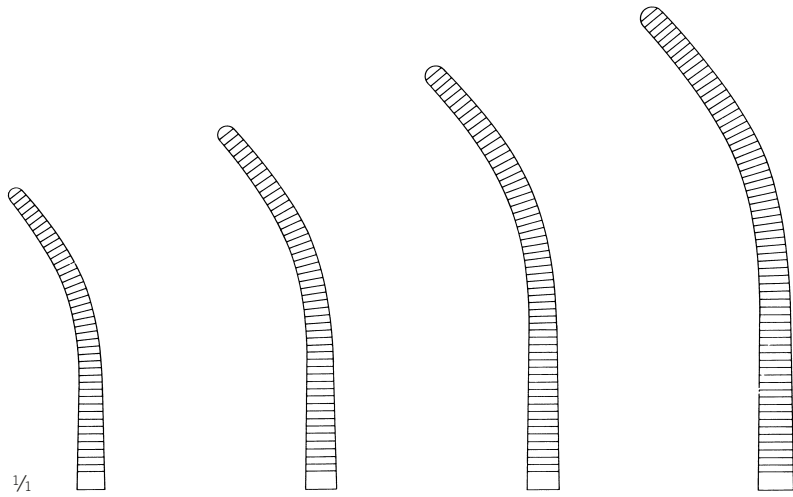

$\frac{1}{4}$

13-411-14-07  
14 cm / 5  $\frac{4}{8}$ "

13-411-16-07  
16,5 cm / 6  $\frac{4}{8}$ "

13-411-18-07  
18,5 cm / 7  $\frac{2}{8}$ "

13-411-20-07  
20,5 cm / 8  $\frac{1}{8}$ "



$\frac{1}{2}$

Pean (Rochester)  
13-411-14-07 -  
13-411-30-07

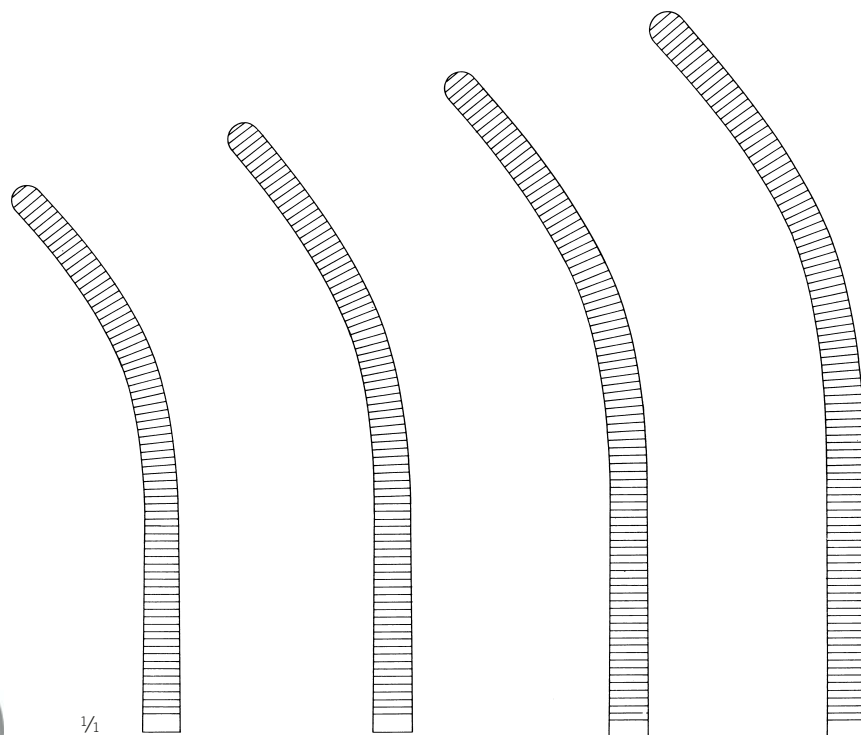

$\frac{1}{4}$

13-411-22-07  
22 cm / 8  $\frac{5}{8}$ "

13-411-24-07  
24 cm / 9  $\frac{4}{8}$ "

13-411-26-07  
26 cm / 10  $\frac{2}{8}$ "

13-411-30-07  
30,5 cm / 12"

# Arterienklemmen

Haemostatic Forceps  
Pinzas hemostáticas  
Pincas hémostatiques  
Pinze emostatiche

# Klemmen

Forceps  
Pinzas  
Pincas  
Pinze



1/1



13-414-14-07  
14,5 cm / 5 7/8"



13-414-16-07  
16,5 cm / 6 4/8"

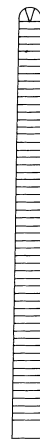

13-414-18-07  
18,5 cm / 7 3/8"

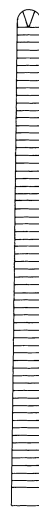

13-414-20-07  
20,5 cm / 8 1/8"



1/2

Kocher (Ochsner)  
13-414-14-07 -  
13-414-30-07

1/1



13-414-22-07  
22,5 cm / 8 7/8"

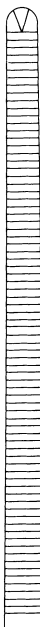

13-414-24-07  
24 cm / 9 4/8"

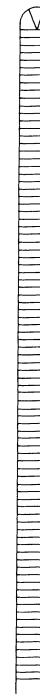

13-414-26-07  
26 cm / 10 2/8"

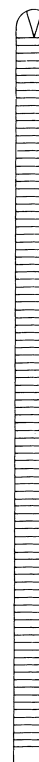

13-414-30-07  
31 cm / 12 2/8"



## Arterienklemmen

Haemostatic Forceps

Pinzas hemostáticas

Pinces hémostatiques

Pinze emostatiche

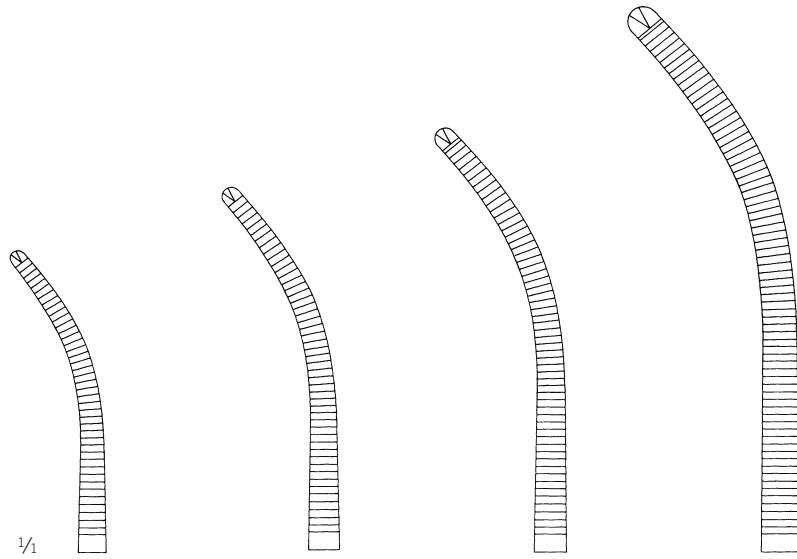

1/4

13-415-14-07

14 cm / 5 4/8"



13-415-16-07

16,5 cm / 6 4/8"



13-415-18-07

18,5 cm / 7 2/8"



13-415-20-07

20 cm / 7 7/8"



1/2

Kocher (Ochsner)

13-415-14-07 -

13-415-30-07

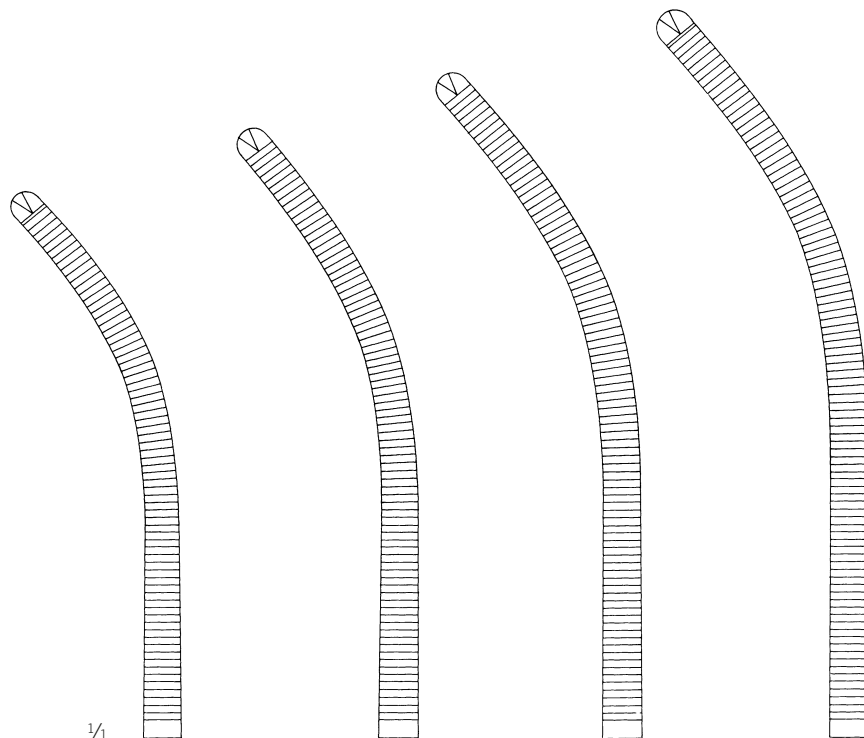

1/4

13-415-22-07

22,5 cm / 8 7/8"



13-415-24-07

24 cm / 9 4/8"



13-415-26-07

26 cm / 10 2/8"



13-415-30-07

30,5 cm / 12"



## Arterienklemmen, Präparierklemmen

Haemostatic Forceps, Dissecting and Ligature Forceps  
Pinzas hemostáticas, Pinzas para preparación y ligadura  
Pincas hémostatiques, Pincas à dissecquer et à ligatures  
Pinze emostatiche, Pinze per preparazioni e legature

## Klemmen

Forceps  
Pinzas  
Pincas  
Pinze



Mixer-Baby  
13-419-18-07  
18,5 cm / 7 <sup>2</sup>/<sub>8</sub>"

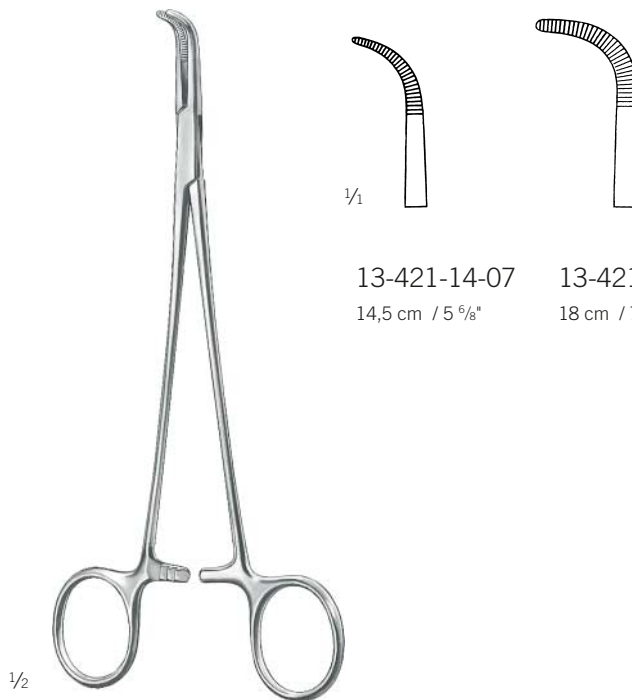

Adson-Baby  
13-421-14-07 -  
13-421-18-07

13-421-14-07  
14,5 cm / 5 <sup>6</sup>/<sub>8</sub>"

13-421-18-07  
18 cm / 7 <sup>1</sup>/<sub>8</sub>"



## Präparierklemmen

Dissecting and Ligature Forceps  
 Pinzas para preparación y ligadura  
 Pincas à disséquer et à ligatures  
 Pinze per preparazioni e legature

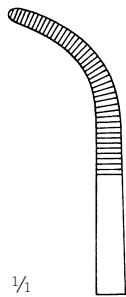

1/1

**Fig. 1**  
 13-443-01-07  
 20,5 cm / 8 1/8"

13-447-01-07  
 27 cm / 10 5/8"

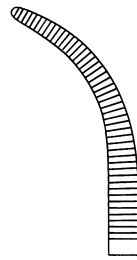

**Fig. 2**  
 13-443-02-07  
 20 cm / 7 7/8"

13-447-02-07  
 26,5 cm / 10 3/8"

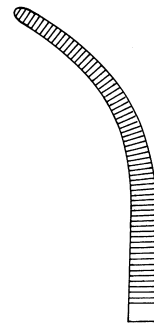

**Fig. 3**  
 13-443-03-07  
 21,5 cm / 8 4/8"

13-447-03-07  
 27,5 cm / 10 7/8"

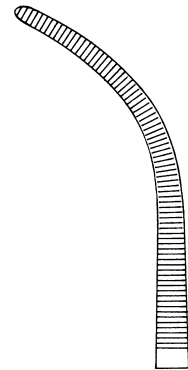

**Fig. 4**  
 13-443-04-07  
 22 cm / 8 5/8"

13-447-04-07  
 28 cm / 11"

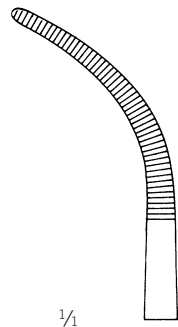

1/1

**Fig. 5**  
 13-443-05-07  
 21,5 cm / 8 4/8"

13-447-05-07  
 27,5 cm / 10 7/8"

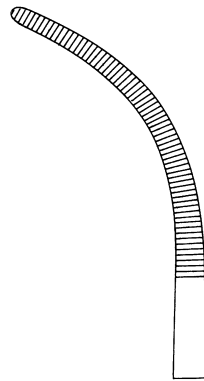

**Fig. 6**  
 13-443-06-07  
 21,5 cm / 8 5/8"

13-447-06-07  
 28 cm / 11"



**Fig. 7**  
 13-443-07-07  
 22 cm / 8 5/8"

13-447-07-07  
 27,5 cm / 10 7/8"



1/2

Overholt-Geissendörfer  
 13-443-01-07 -  
 13-447-07-07

## Präparierklemmen

Dissecting and Ligature Forceps  
Pinzas para preparación y ligadura  
Pincès à disséquer et à ligatures  
Pinze per preparazioni e legature

## Klemmen

Forceps  
Pinzas  
Pincès  
Pinze



1/2

Gemini  
13-451-13-07 -  
13-451-28-07

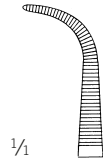

1/1

13-451-13-07  
13 cm / 5 1/8"

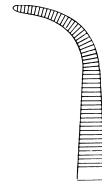

13-451-16-07  
16 cm / 6 2/8"



13-451-18-07  
18 cm / 7 1/8"



13-451-20-07  
21 cm / 8 2/8"

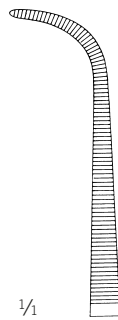

1/1

13-451-23-07  
23 cm / 9"

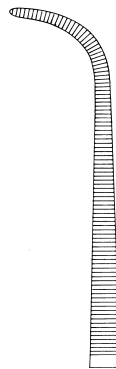

13-451-25-07  
25 cm / 9 7/8"

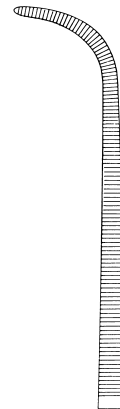

13-451-28-07  
28 cm / 11"



1/2

Mini-Gemini  
13-453-18-07 -  
13-453-28-07

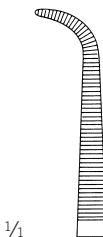

1/1

13-453-18-07  
18 cm / 7 1/8"



13-453-22-07  
23 cm / 9"



13-453-25-07  
25 cm / 9 7/8"



13-453-28-07  
28,5 cm / 11 2/8"

## Tuchklemmen

Towel Clamps  
Pinzas de campo  
Pincas à champs  
Pinze fissatele

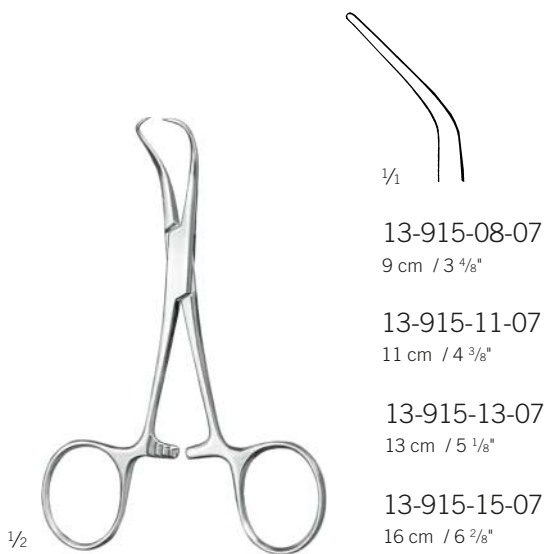

Backhaus  
13-915-08-07 -  
13-915-15-07

scharf  
sharp  
agudo  
pointu  
acuto



13-924-11-07 -  
13-924-14-07

für Papierabdeckung  
for paper drapes  
para paños de papel  
pour couverture en papier  
per copertura di carta

Wundhaken, Halte- und Spreizsysteme  
Retractors, Holding and spreading systems  
Separadores, Sistemas de sujeción y dispersión  
Ecarteurs, Systèmes de maintien et d'épandage  
Divaricatori, Sistemi di tenuta e diffusione

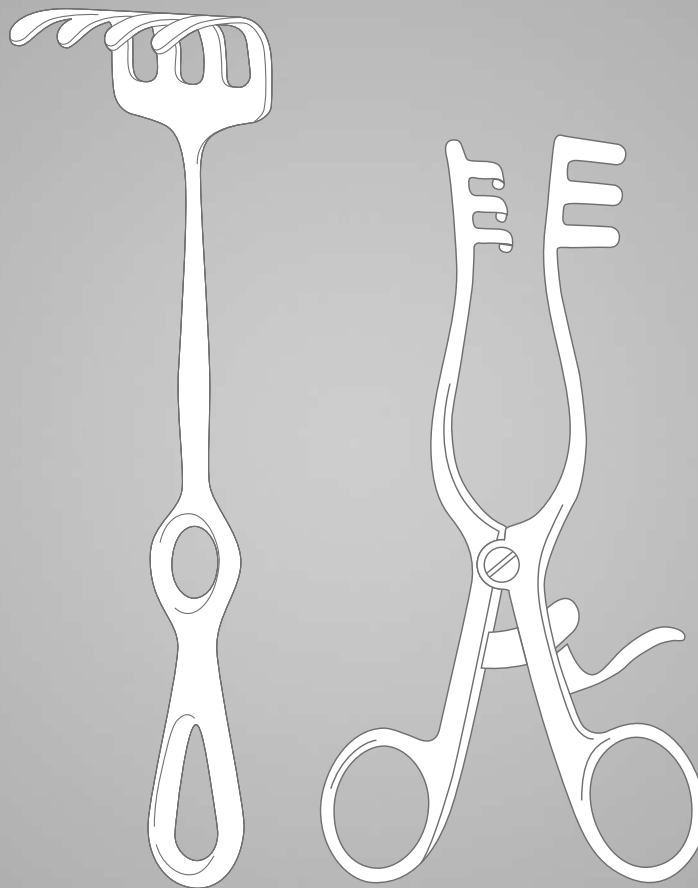

## Hauthäkchen, Wundhäkchen

Skin Hooklets, Hooklets  
 Ganchitos para piel, Ganchitos  
 Erignes cutanées, Crochetes  
 Uncini cutanei, Divaricatori

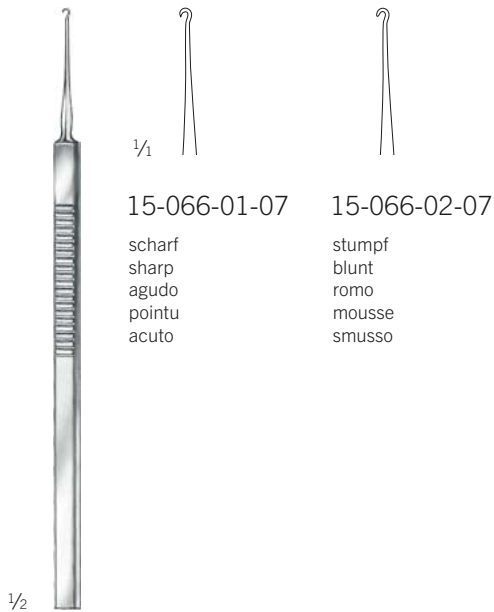

15-066-01-07

scharf  
 sharp  
 agudo  
 pointu  
 acuto

15-066-02-07

stumpf  
 blunt  
 romo  
 mousse  
 smusso

Graefe  
 15-066-01-07 - 15-066-02-07  
 15 cm / 5 7/8"

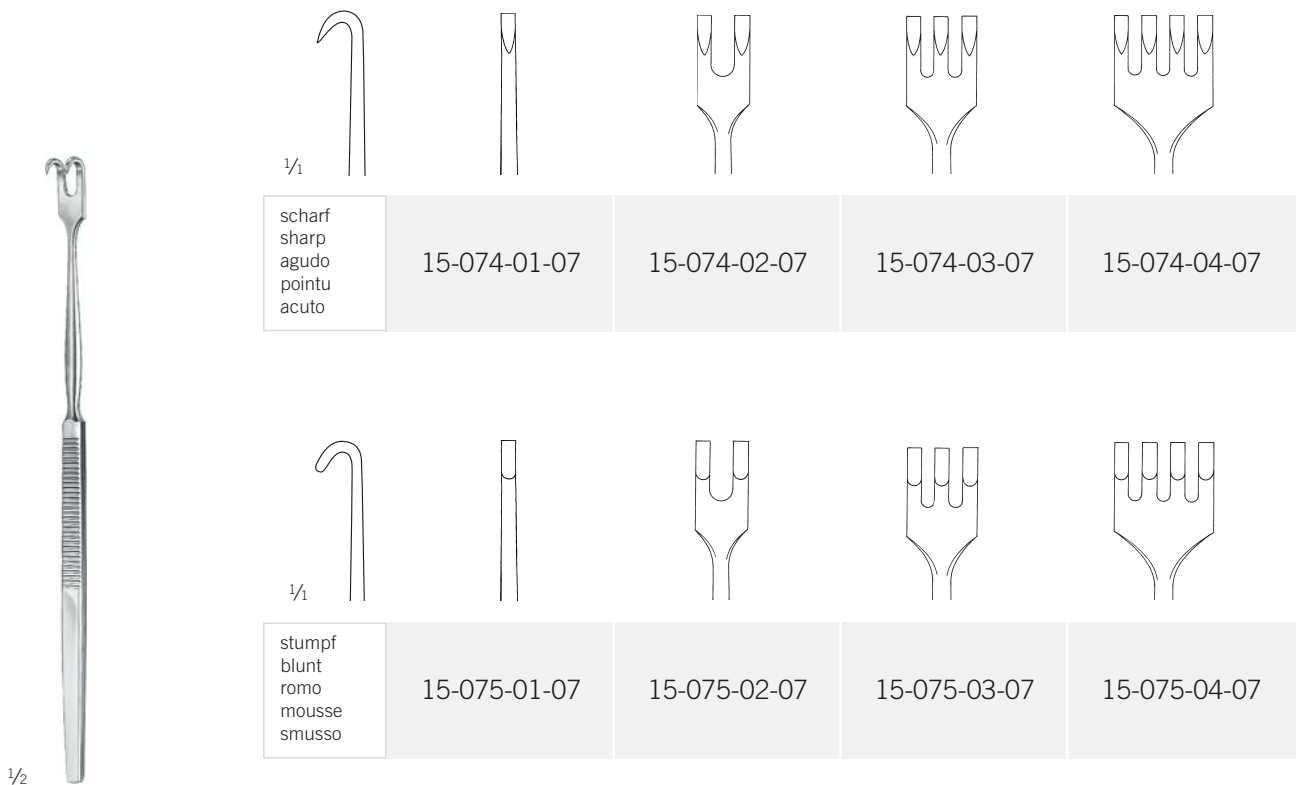

scharf  
 sharp  
 agudo  
 pointu  
 acuto

15-074-01-07

15-074-02-07

15-074-03-07

15-074-04-07

stumpf  
 blunt  
 romo  
 mousse  
 smusso

15-075-01-07

15-075-02-07

15-075-03-07

15-075-04-07

15-074-01-07 -  
 15-075-04-07  
 16,5 cm / 6 4/8"

## Sattelhäkchen, Wundhäkchen

Saddle Hooks, Hooklets

Ganchos en forma de silla, Ganchitos

Ecarteurs sous forme de selle, Crochetes

Divaricatori a forma di sella, Divaricatori

## Wundhaken, Halte- und Spreizsysteme

Retractors, Holding and spreading systems

Separadores, Sistemas de sujeción y dispersión

Ecarteurs, Systèmes de maintien et d'épandage

Divaricatori, Sistemi di tenuta e diffusione



Desmarres

15-091-08-07 -

15-091-18-07

16 cm / 6 2/8"



Langenbeck-Mini

15-095-10-07 -

15-095-22-07

16 cm / 6 2/8"

# Wundhäkchen

Hooklets  
Ganchitos  
Crochetes  
Divaricatori

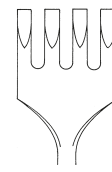
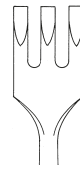
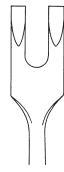
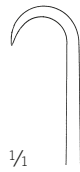

scharf sharp agudo pointu acuto	15-100-01-07	15-100-02-07	15-100-03-07	15-100-04-07
---	--------------	--------------	--------------	--------------

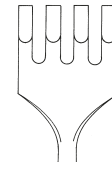
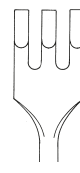

stumpf blunt romo mousse smusso	15-101-01-07	15-101-02-07	15-101-03-07	15-101-04-07
---	--------------	--------------	--------------	--------------

1/2

15-100-01-07 -  
15-101-04-07  
16,5 cm / 6 1/8"



**Fig. 1**  
15-161-01-07  
20 x 6 mm



**Fig. 2**  
15-161-02-07  
10 x 6 mm

1/2

Senn-Green  
15-161-01-07 -  
15-161-02-07  
16 cm / 6 2/8"

## Sattelhäkchen

Saddle Hooks

Ganchos en forma de silla

Ecarteurs sous forme de selle

Divaricatori a forma di sella

## Wundhaken, Halte- und Spreizsysteme

Retractors, Holding and spreading systems

Separadores, Sistemas de sujeción y dispersión

Ecarteurs, Systèmes de maintien et d'épandage

Divaricatori, Sistemi di tenuta e diffusione

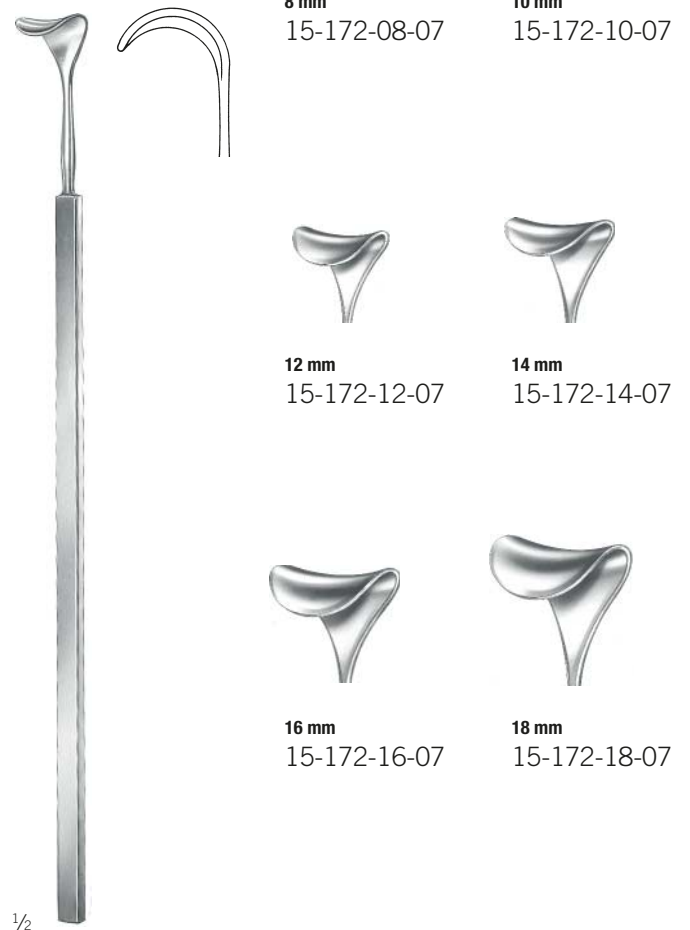
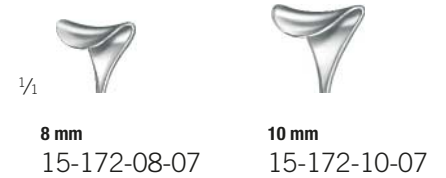
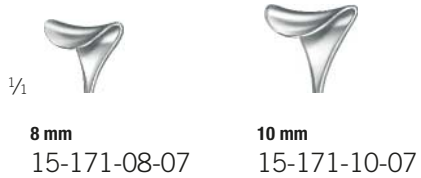

Cushing  
15-171-08-07 -  
15-171-18-07  
20,5 cm / 8  $\frac{1}{8}$ "

Cushing  
15-172-08-07 -  
15-172-18-07  
24 cm / 9  $\frac{4}{8}$ "



# Wundhaken

Retractors  
Separadores  
Ecarteurs  
Divaricatori

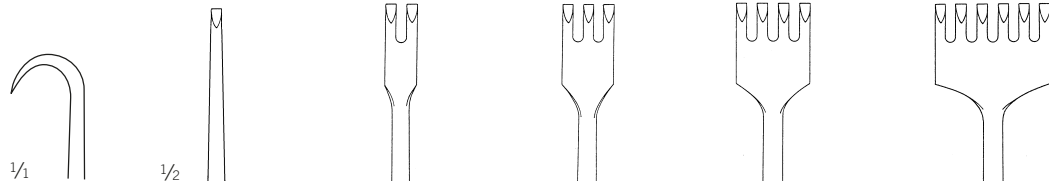

scharf sharp agudo pointu acuto	15-220-01-07	15-220-02-07	15-220-03-07	15-220-04-07	15-220-06-07
---	--------------	--------------	--------------	--------------	--------------

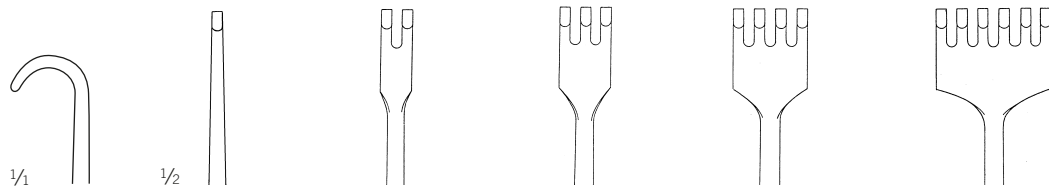

stumpf blunt romo mousse smusso	15-221-01-07	15-221-02-07	15-221-03-07	15-221-04-07	15-221-06-07
---	--------------	--------------	--------------	--------------	--------------

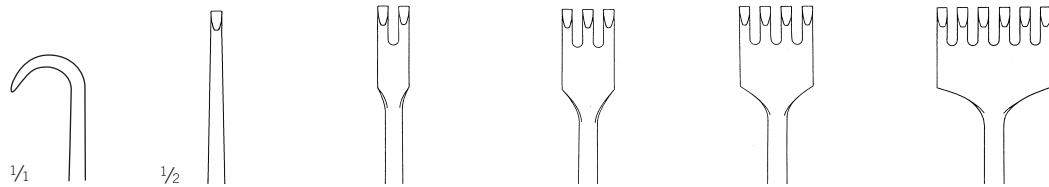

halbscharf semi-sharp semi-agudo semi-pointu semi acuto	15-222-01-07	15-222-02-07	15-222-03-07	15-222-04-07	15-222-06-07
---	--------------	--------------	--------------	--------------	--------------



1/2

Volkman  
15-220-01-07 -  
15-222-06-07  
22,5 cm / 8 7/8"

## Wundhaken

Retractors  
Separadores  
Ecarteurs  
Divaricatori

## Wundhaken, Halte- und Spreizsysteme

Retractors, Holding and spreading systems  
Separadores, Sistemas de sujeción y dispersión  
Ecarteurs, Systèmes de maintien et d'épandage  
Divaricatori, Sistemi di tenuta e diffusione

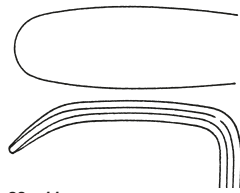

30 x 11 mm  
15-293-01-07

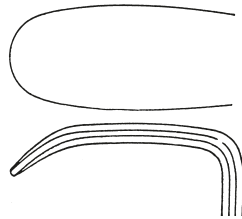

30 x 14 mm  
15-293-02-07

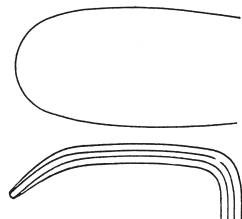

30 x 15 mm  
15-293-03-07

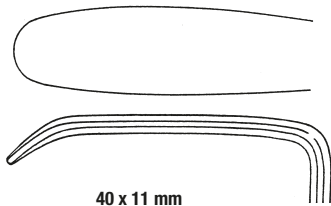

40 x 11 mm  
15-293-04-07

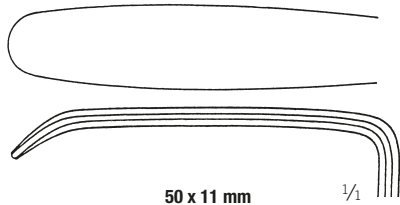

50 x 11 mm  
15-293-05-07



1/2

Langenbeck  
15-293-01-07 -  
15-293-05-07  
22 cm / 8 5/8"

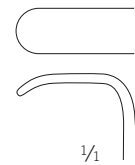

1/4

6 x 16 mm  
15-301-16-07

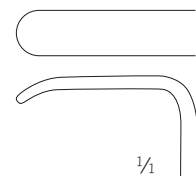

1/4

6 x 25 mm  
15-301-25-07



1/2

Langenbeck-Green  
15-301-16-07 -  
15-301-25-07  
16 cm / 6 2/8"

## Wundhaken

Retractors  
Separadores  
Ecarteurs  
Divaricatori



Kocher-Langenbeck  
15-317-01-07 -  
15-317-09-07  
21,5 cm / 8 4/8"



25 x 6 mm  
15-317-01-07

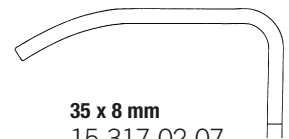
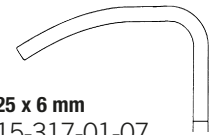

35 x 8 mm  
15-317-02-07

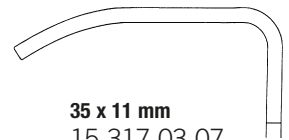

35 x 11 mm  
15-317-03-07

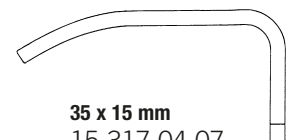

35 x 15 mm  
15-317-04-07

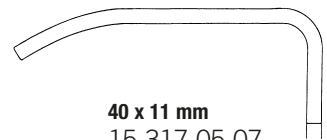

40 x 11 mm  
15-317-05-07

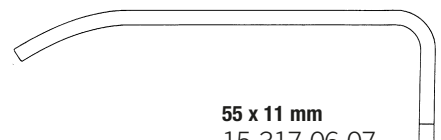

55 x 11 mm  
15-317-06-07

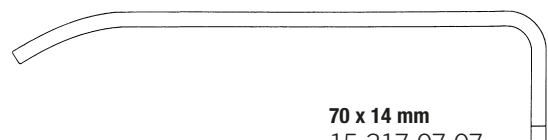

70 x 14 mm  
15-317-07-07

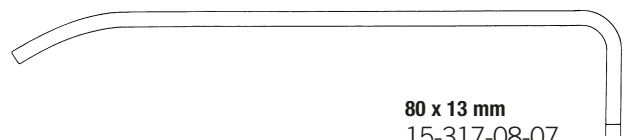

80 x 13 mm  
15-317-08-07

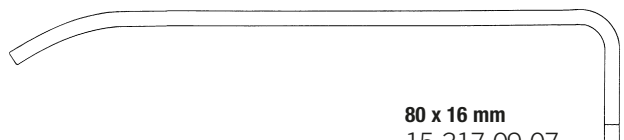

80 x 16 mm  
15-317-09-07

1/1

## Wundhaken

Retractors  
Separadores  
Ecarteurs  
Divaricatori

## Wundhaken, Halte- und Spreizsysteme

Retractors, Holding and spreading systems  
Separadores, Sistemas de sujeción y dispersión  
Ecarteurs, Systèmes de maintien et d'épandage  
Divaricatori, Sistemi di tenuta e diffusione



Roux  
15-655-00-01 -  
15-655-03-01

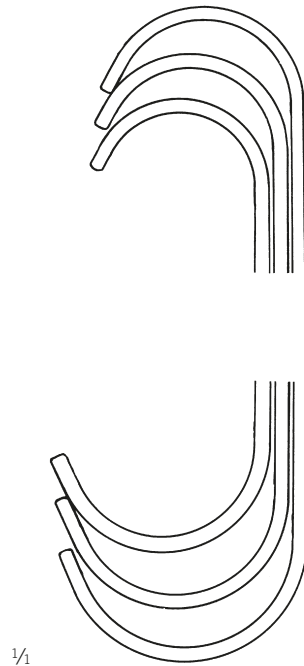

**Fig. 1 - 3**  
15-655-00-01  
17 cm / 6 6/8"  
Satz  
Set

**Fig. 1**

22 x 21 mm  
27 x 29 mm  
15-655-01-01  
14,5 cm / 5 7/8"

**Fig. 2**

25 x 26 mm  
30 x 38 mm  
15-655-02-01  
16 cm / 6 2/8"

**Fig. 3**

28 x 29 mm  
33 x 43 mm  
15-655-03-01  
17 cm / 6 6/8"

# Haken

Hooks  
Ganchos  
Crochets  
Uncini

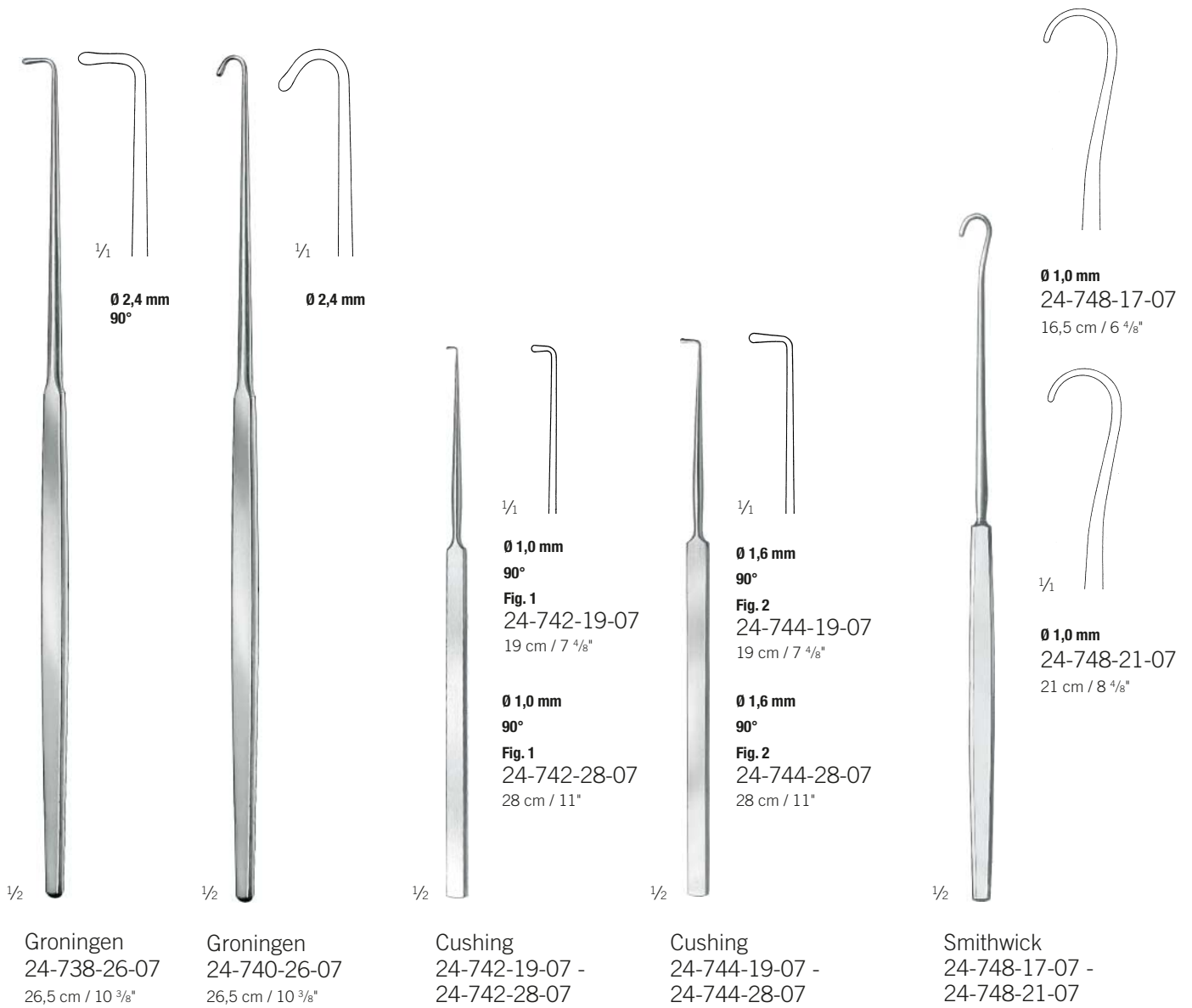

## Haken

Hooks  
Ganchos  
Crochets  
Uncini

## Wundhaken, Halte- und Spreizsysteme

Retractors, Holding and spreading systems  
Separadores, Sistemas de sujeción y dispersión  
Ecarteurs, Systèmes de maintien et d'épandage  
Divaricatori, Sistemi di tenuta e diffusione

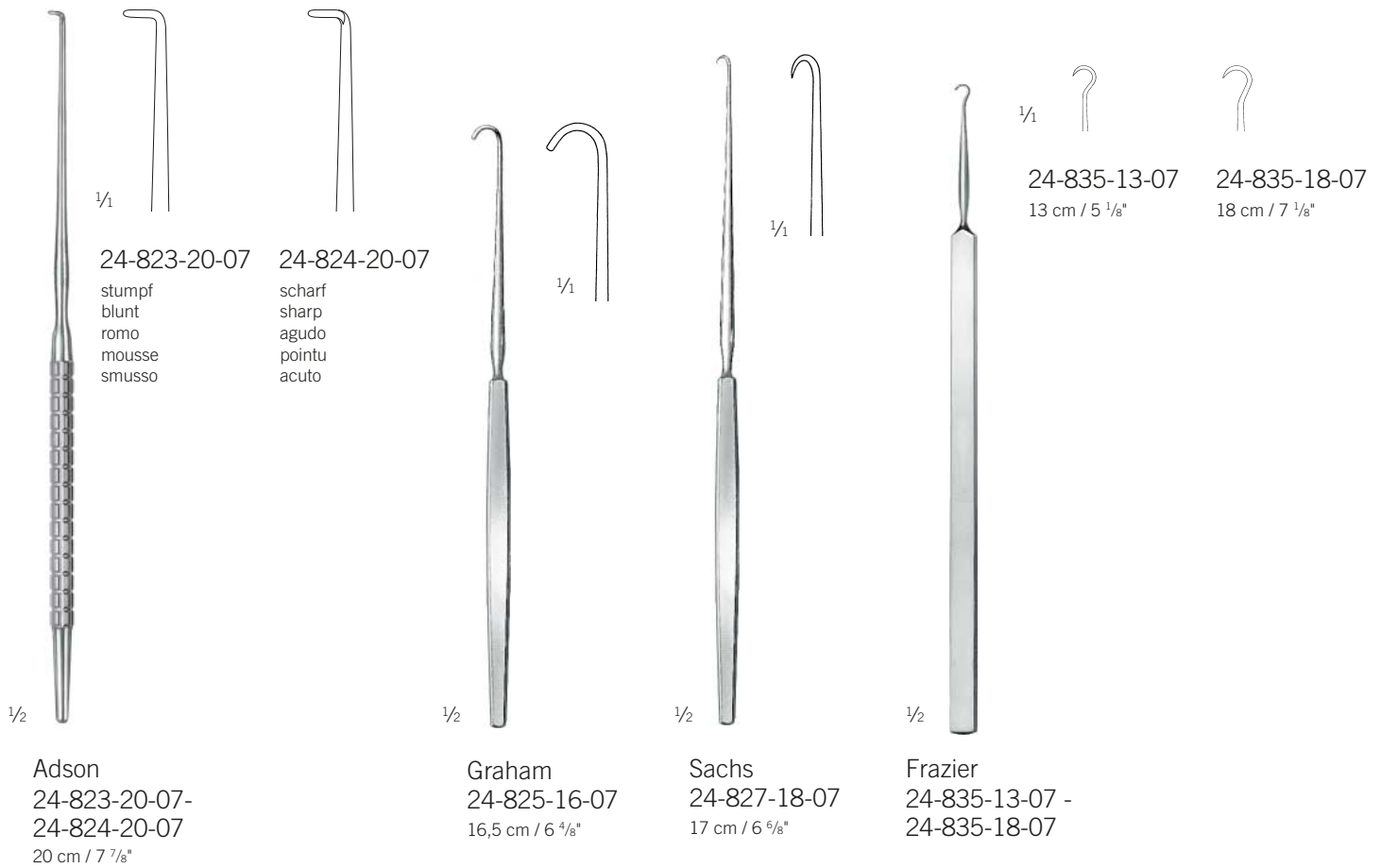

## Nasenhäkchen, Schleimhauthäkchen

Nasal Hooklets, Mucosa Hooklet

Ganchitos nasales, Ganchito para mucosa

Crochets nasaux, Crochet pour la muqueuse

Uncini nasali, Uncino per mucosa



6,2 mm  
160°

Joseph  
37-684-15-07

15,5 cm / 6 1/8"

Schleimhauthäkchen, scharf  
Mucosa hooklet, sharp  
Ganchito para mucosa, agudo  
Crochet pour la muqueuse, pointu  
Uncino per mucosa, acuto

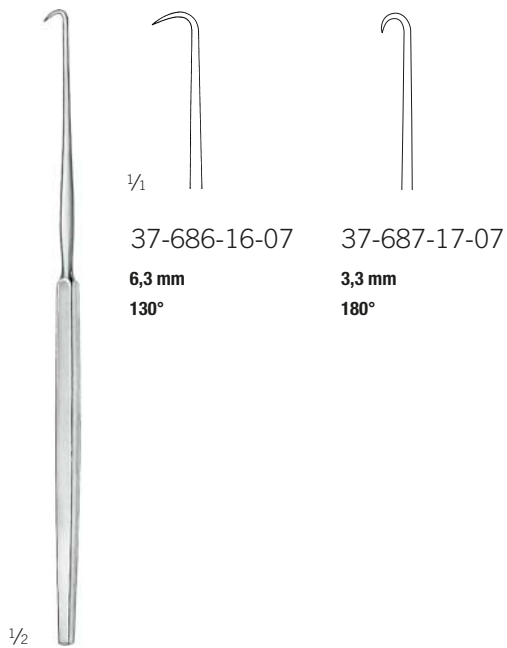

37-686-16-07

6,3 mm  
130°

37-687-17-07

3,3 mm  
180°

Cottle  
37-686-16-07 - 37-687-17-07

17 cm / 6 1/8"

scharf  
sharp  
agudo  
pointu  
acuto



Freer  
37-702-15-07

15 cm / 5 7/8"

scharf  
sharp  
agudo  
pointu  
acuto

## Schleimhauthäkchen

Mucosa Hooklet

Ganchito para mucosa

Crochet pour la muqueuse

Uncino per mucosa

## Wundhaken, Halte- und Spreizsysteme

Retractors, Holding and spreading systems

Separadores, Sistemas de sujeción y dispersión

Ecarteurs, Systèmes de maintien et d'épandage

Divaricatori, Sistemi di tenuta e diffusione

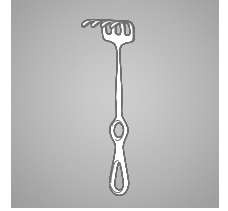

1/1



37-704-02-07

2 mm



37-704-05-07

5 mm

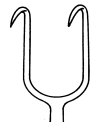

37-704-07-07

7 mm

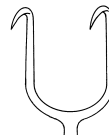

37-704-10-07

10 mm

1/2

Joseph

37-704-02-07 - 37-704-10-07

16 cm / 6 1/8"



## Wundspreizer, selbsthaltend

Wound Spreaders, self-retaining

Separadores autoestáticos

Ecarteurs autostatiques

Divaricatori autostatici

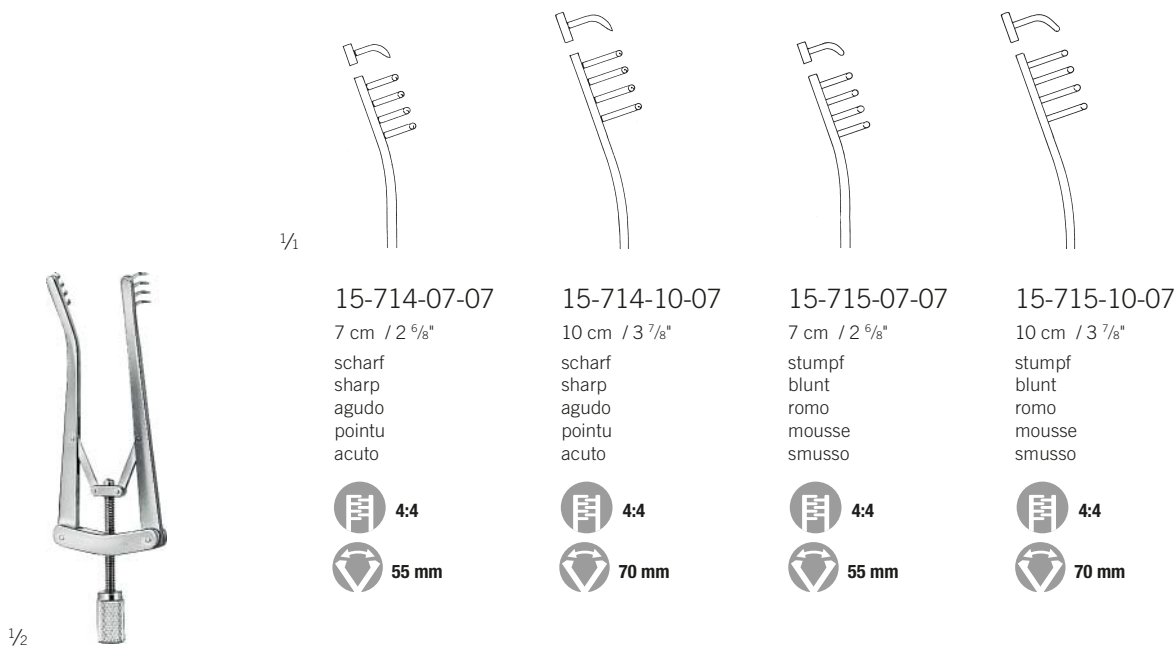
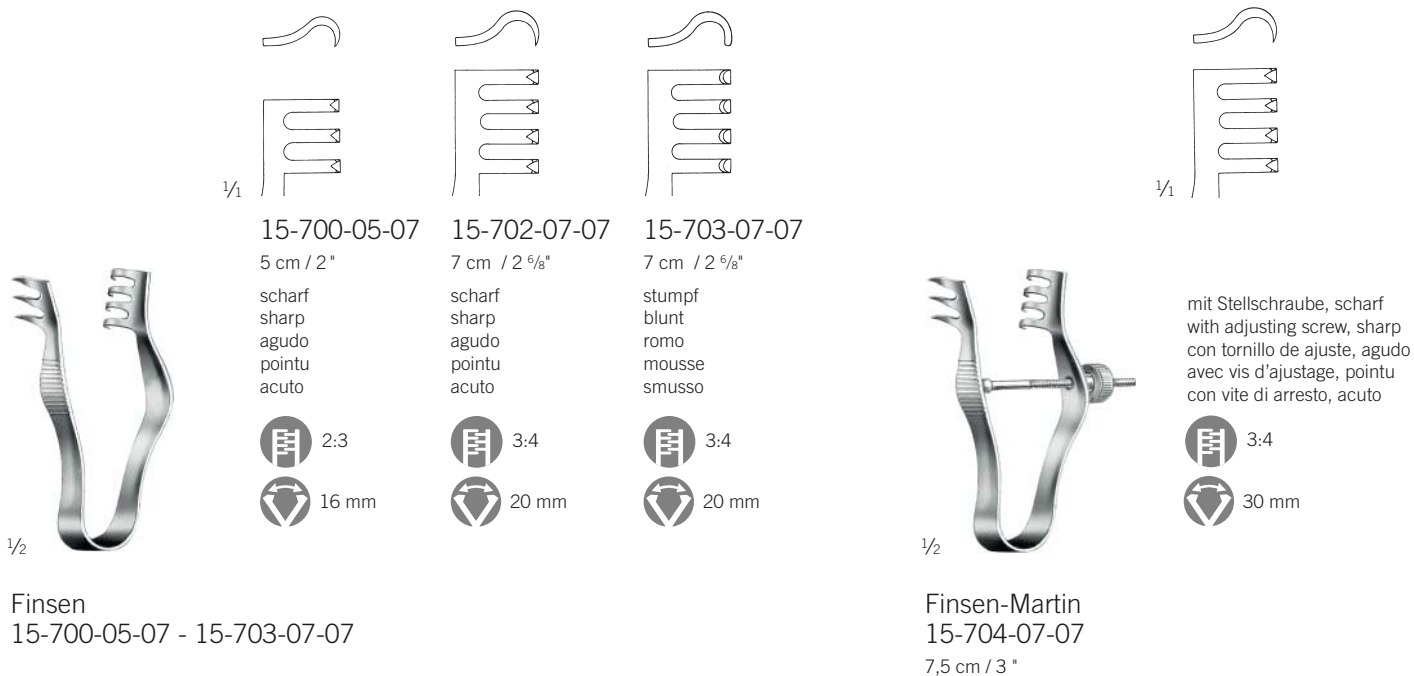

## Wundspreizer, selbsthaltend

Wound Spreaders, self-retaining

Separadores autoestáticos

Ecarteurs autostatiques

Divaricatori autostatici

## Wundhaken, Halte- und Spreizsysteme

Retractors, Holding and spreading systems

Separadores, Sistemas de sujeción y dispersión

Ecarteurs, Systèmes de maintien et d'épandage

Divaricatori, Sistemi di tenuta e diffusione

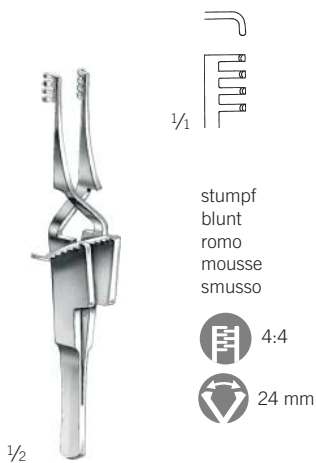

15-717-10-07  
10 cm / 3 7/8"

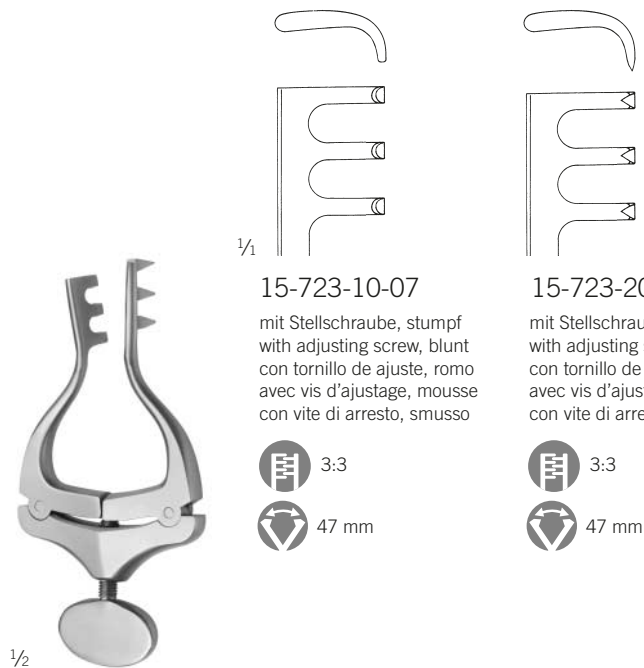

Jansen  
15-723-10-07 - 15-723-20-07  
10 cm / 3 7/8"

## Wundspreizer, selbsthaltend

Wound Spreaders, self-retaining

Separadores autoestáticos

Ecarteurs autostatiques

Divaricatori autostatici



1/2

Scalp-Contour  
15-725-14-07 -  
15-727-14-07  
13,5 cm / 5 3/8"

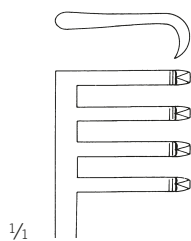

1/1

15-725-14-07

13,5 cm / 5 3/8"

scharf

sharp

agudo

pointu

acuto



3:4



55 mm

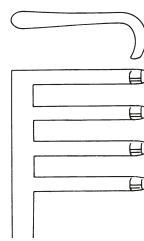

1/1

15-727-14-07

13,5 cm / 5 3/8"

stumpf

blunt

romo

mousse

smusso



3:4



55 mm

## Wundspreizer, selbsthaltend

Wound Spreaders, self-retaining

Separadores autoestáticos

Ecarteurs autostatiques

Divaricatori autostatici

## Wundhaken, Halte- und Spreizsysteme

Retractors, Holding and spreading systems

Separadores, Sistemas de sujeción y dispersión

Ecarteurs, Systèmes de maintien et d'épandage

Divaricatori, Sistemi di tenuta e diffusione

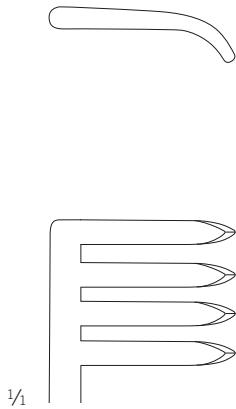

1/4

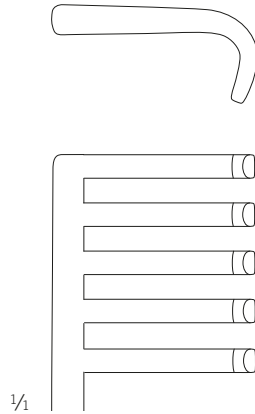

1/4

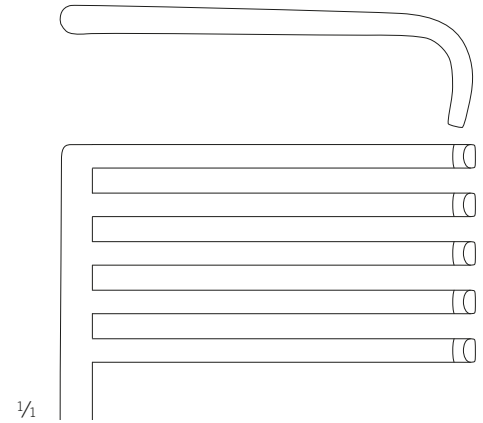

1/4



1/2

Anderson-Adson  
15-732-20-07

19 cm / 7 4/8"

scharf  
sharp  
agudo  
pointu  
acuto



4:4



84 mm



1/2

Travers  
15-733-21-07

21,5 cm / 8 4/8"

stumpf  
blunt  
romo  
mousse  
smusso



4:5



95 mm



1/2

Norfolk-Norwich  
15-733-22-07

22 cm / 8 5/8"

stumpf  
blunt  
romo  
mousse  
smusso



4:5



110 mm

## Wundspreizer, selbsthaltend

Wound Spreaders, self-retaining

Separadores autoestáticos

Ecarteurs autostatiques

Divaricatori autostatici

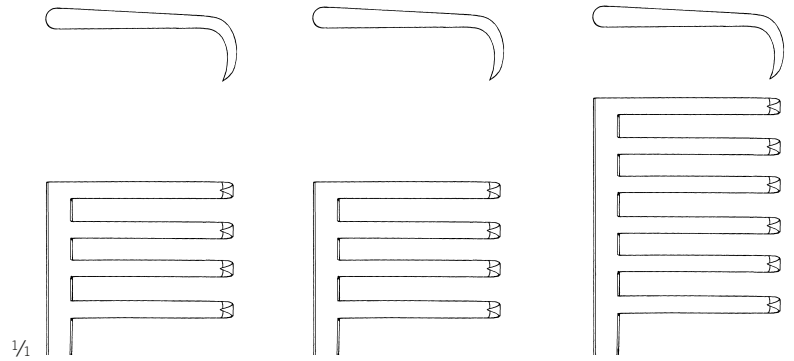

scharf sharp agudo pointu acuto		15-734-20-07	15-734-24-07	15-734-26-07
		20 cm / 7 7/8"	24 cm / 9 4/8"	25,5 cm / 10"
		3:4	3:4	5:6
		90 mm	90 mm	90 mm

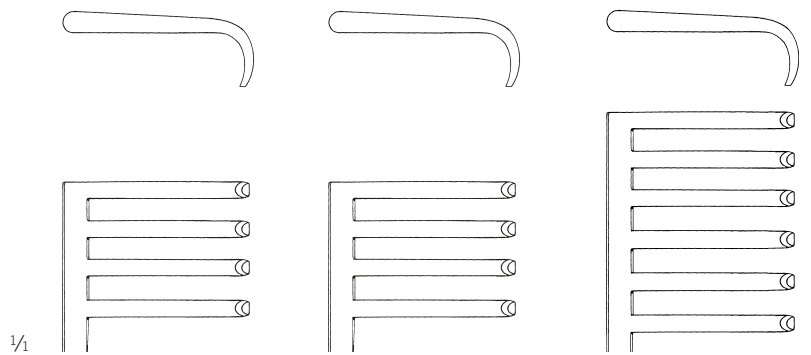

stumpf blunt romo mousse smusso		15-735-20-07	15-735-24-07	15-735-26-07
		20 cm / 7 7/8"	24 cm / 9 4/8"	25,5 cm / 10"
		3:4	3:4	5:6
		90 mm	90 mm	90 mm

Weitlaner  
15-734-20-07 -  
15-735-26-07

## Wundspreizer, selbsthaltend

Wound Spreaders, self-retaining

Separadores autoestáticos

Ecarteurs autostatiques

Divaricatori autostatici

## Wundhaken, Halte- und Spreizsysteme

Retractors, Holding and spreading systems

Separadores, Sistemas de sujeción y dispersión

Ecarteurs, Systèmes de maintien et d'épandage

Divaricatori, Sistemi di tenuta e diffusione

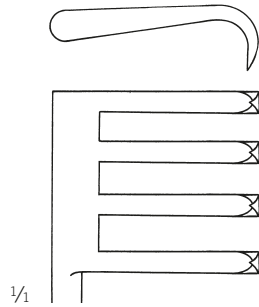

1/4

15-736-26-07

26 cm / 10 3/8"

scharf  
sharp  
agudo  
pointu  
acuto



3:4



100 mm

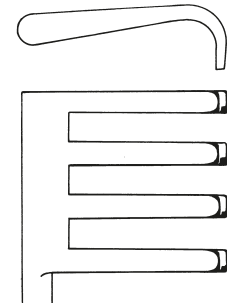

15-737-26-07

26 cm / 10 3/8"

stumpf  
blunt  
romo  
mousse  
smusso



3:4



100 mm



1/2

Adson

15-736-26-07 -

15-739-26-07

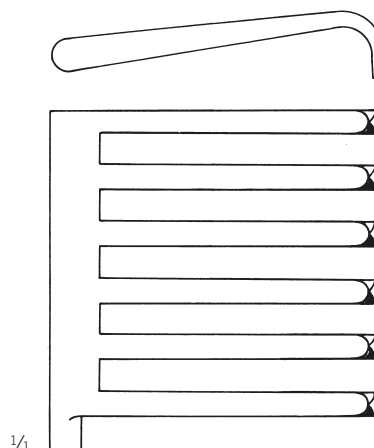

1/4

15-738-26-07

29 cm / 11 3/8"

scharf  
sharp  
agudo  
pointu  
acuto



6:6



110 mm

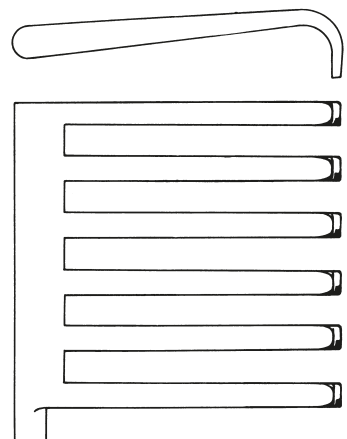

15-739-26-07

29 cm / 11 3/8"

stumpf  
blunt  
romo  
mousse  
smusso



6:6



110 mm

## Wundspreizer, selbsthaltend

Wound Spreaders, self-retaining

Separadores autoestáticos

Ecarteurs autostatiques

Divaricatori autostatici

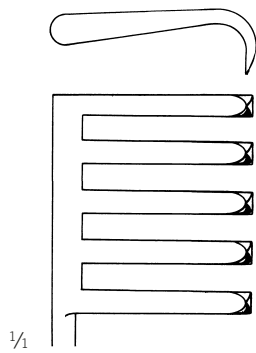

15-738-25-07

scharf  
sharp  
agudo  
pointu  
acuto



5:6



110 mm

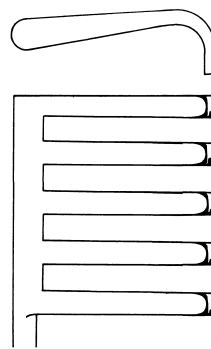

15-739-25-07

stumpf  
blunt  
romo  
mousse  
smusso



5:6



110 mm

15-738-25-07 -  
15-739-25-07  
25,5 cm / 10"

## Wundspreizer, selbsthaltend

Wound Spreaders, self-retaining

Separadores autoestáticos

Ecarteurs autostatiques

Divaricatori autostatici

## Wundhaken, Halte- und Spreizsysteme

Retractors, Holding and spreading systems

Separadores, Sistemas de sujeción y dispersión

Ecarteurs, Systèmes de maintien et d'épandage

Divaricatori, Sistemi di tenuta e diffusione



1/2

15-740-13-07 -  
15-741-13-07

13,5 cm / 5 3/8"

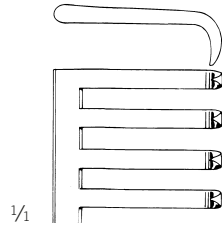

1/1

15-740-13-07

scharf  
sharp  
agudo  
pointu  
acuto



3:4



43 mm

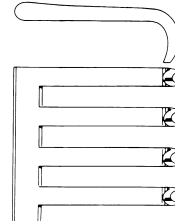

15-741-13-07

stumpf  
blunt  
romo  
mousse  
smusso



3:4



43 mm



1/2

Weitlaner  
15-748-10-07 -  
15-749-10-07

11 cm / 4 3/8"

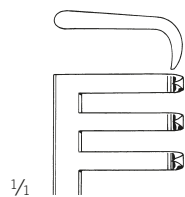

1/1

15-748-10-07

scharf  
sharp  
agudo  
pointu  
acuto



2:3



40 mm

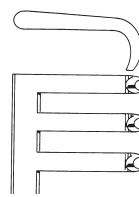

15-749-10-07

stumpf  
blunt  
romo  
mousse  
smusso



2:3



40 mm



## Wundspreizer, selbsthaltend

Wound Spreaders, self-retaining

Separadores autoestáticos

Ecarteurs autostatiques

Divaricatori autostatici

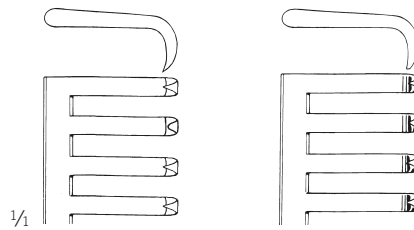

scharf sharp agudo pointu acuto		15-750-13-07	15-750-16-07
		13,5 cm / 5 3/8"	16 cm / 6 2/8"
		43 mm	83 mm
		3:4	3:4

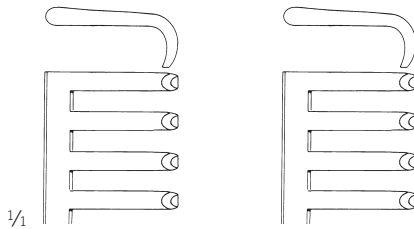

stumpf blunt romo mousse smusso		15-751-13-07	15-751-16-07
		13,5 cm / 5 3/8"	16 cm / 6 2/8"
		43 mm	83 mm
		3:4	3:4



1/2

Weitlaner  
15-750-13-07 -  
15-751-16-07

## Wundspreizer, selbsthaltend

Wound Spreaders, self-retaining

Separadores autoestáticos

Ecarteurs autostatiques

Divaricatori autostatici

## Wundhaken, Halte- und Spreizsysteme

Retractors, Holding and spreading systems

Separadores, Sistemas de sujeción y dispersión

Ecarteurs, Systèmes de maintien et d'épandage

Divaricatori, Sistemi di tenuta e diffusione



1/2

Weitlaner-Wullstein

15-752-13-07 -

15-753-13-07

13 cm / 5 1/8"

1/4

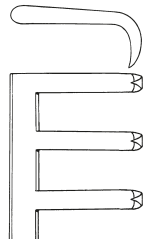

15-752-13-07

scharf  
sharp  
agudo  
pointu  
acuto



3:3



40 mm

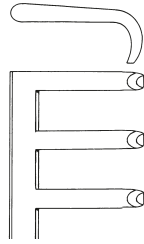

15-753-13-07

stumpf  
blunt  
romo  
mousse  
smusso



3:3



40 mm



1/2

Mollison

15-754-15-07

15,5 cm / 6 1/8"

1/4

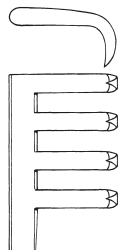

scharf  
sharp  
agudo  
pointu  
acuto



4:4



80 mm

## Wundspreizer, selbsthaltend

Wound Spreaders, self-retaining

Separadores autoestáticos

Ecarteurs autostatiques

Divaricatori autostatici

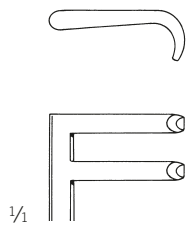

15-755-13-07

stumpf  
blunt  
romo  
mousse  
smusso



2:2



37 mm

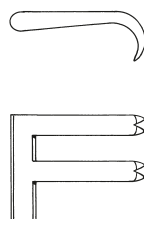

15-756-13-07

scharf  
sharp  
agudo  
pointu  
acuto



2:2



37 mm

Plester  
15-755-13-07 -  
15-756-13-07  
13 cm / 5 1/8"

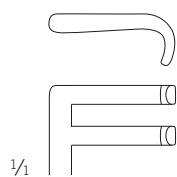

Plester  
15-757-11-07  
10,5 cm / 4 1/8"

stumpf  
blunt  
romo  
mousse  
smusso



37 mm

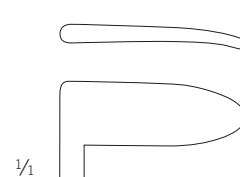

Plester  
15-759-11-07  
10,5 cm / 4 1/8"

stumpf  
blunt  
romo  
mousse  
smusso



37 mm

## Wundspreizer, selbsthaltend

Wound Spreaders, self-retaining

Separadores autoestáticos

Ecarteurs autostatiques

Divaricatori autostatici

## Wundhaken, Halte- und Spreizsysteme

Retractors, Holding and spreading systems

Separadores, Sistemas de sujeción y dispersión

Ecarteurs, Systèmes de maintien et d'épandage

Divaricatori, Sistemi di tenuta e diffusione

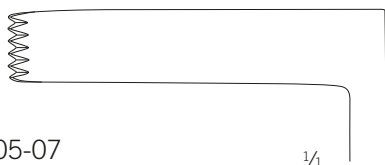

15-762-05-07

1/4

**50 x 10 mm**

Valve links voll

Blade left full

Valva a la izquierda plena

Valve sur le bras à gauche

Valva sul braccio sinistro

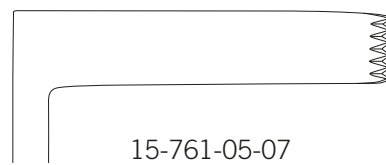

1/4

15-761-05-07

**50 x 10 mm**

Valve rechts voll

Blade rightfull

Valva a la derecha plena

Valve sur le bras à droite

Valva sul braccio destro

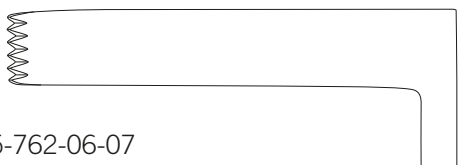

15-762-06-07

**60 x 10 mm**

Valve links voll

Blade left full

Valva a la izquierda plena

Valve sur le bras à gauche

Valva sul braccio sinistro

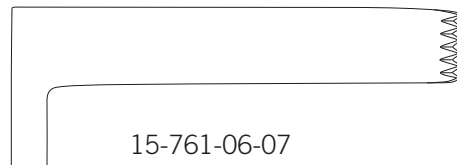

15-761-06-07

**60 x 10 mm**

Valve rechts voll

Blade rightfull

Valva a la derecha plena

Valve sur le bras à droite

Valva sul braccio destro



15-762-07-07

**70 x 10 mm**

Valve links voll

Blade left full

Valva a la izquierda plena

Valve sur le bras à gauche

Valva sul braccio sinistro

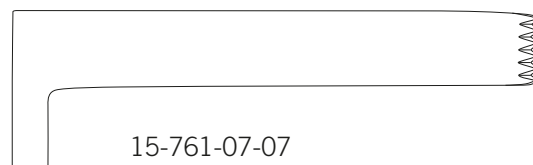

15-761-07-07

**70 x 10 mm**

Valve rechts voll

Blade rightfull

Valva a la derecha plena

Valve sur le bras à droite

Valva sul braccio destro



1/2

Williams

15-761-05-07 -

15-762-07-07

17 cm / 6 5/8"

## Wundspreizer, selbsthaltend

Wound Spreaders, self-retaining

Separadores autoestáticos

Ecarteurs autostatiques

Divaricatori autostatici

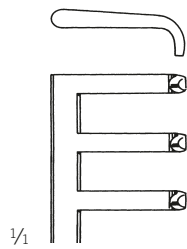

stumpf  
blunt  
romo  
mousse  
smusso



$\frac{1}{2}$

Milligan  
15-765-13-07  
13,5 cm / 5  $\frac{3}{8}$ "

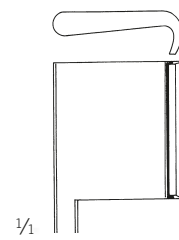
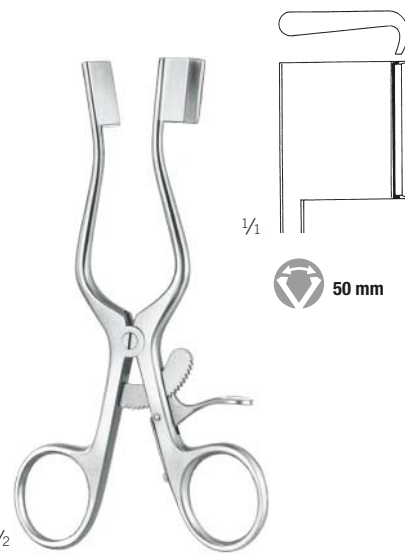

$\frac{1}{2}$

Weitlaner-Baby  
15-767-13-07  
13,5 cm / 5  $\frac{3}{8}$ "

## Wundspreizer, selbsthaltend, Mittelvalven

Wound Spreaders, self-retaining, Central Blades

Separadores autoestáticos, valvas centrales

Ecarteurs autostatiques, valves centrales

Divaricatori autostatici, valve centrali

## Wundhaken, Halte- und Spreizsysteme

Retractors, Holding and spreading systems

Separadores, Sistemas de sujeción y dispersión

Ecarteurs, Systèmes de maintien et d'épandage

Divaricatori, Sistemi di tenuta e diffusione

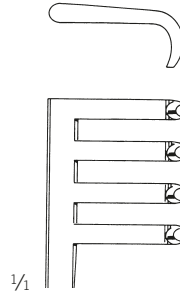

1/1

15-768-00-07



3:4

stumpf  
blunt  
romo  
mousse  
smusso

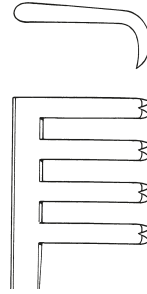

15-769-00-07



3:4

scharf  
sharp  
agudo  
pointu  
acuto



1/2

Henley  
15-768-00-07 -  
15-769-00-07

16,5 cm / 6 4/8"



85 mm

komplett mit 3 Mittelvalven  
Art.-Nr. 15-768-19-07, 15-768-25-07 und 15-768-32-07

complete with 3 central blades  
ref. 15-768-19-07, 15-768-25-07 and 15-768-32-07

completo con 3 valvas centrales  
ref. 15-768-19-07, 15-768-25-07 y 15-768-32-07

complet avec 3 valves centrales  
réf. 15-768-19-07, 15-768-25-07 et 15-768-32-07

completo con 3 valve centrali  
rif. 15-768-19-07, 15-768-25-07 e 15-768-32-07



1/2

15-768-19-07

19 x 17 mm



15-768-25-07

25 x 17 mm



15-768-32-07

32 x 17 mm

## Wundspreizer, selbsthaltend

Wound Spreaders, self-retaining

Separadores autoestáticos

Ecarteurs autostatiques

Divaricatori autostatici

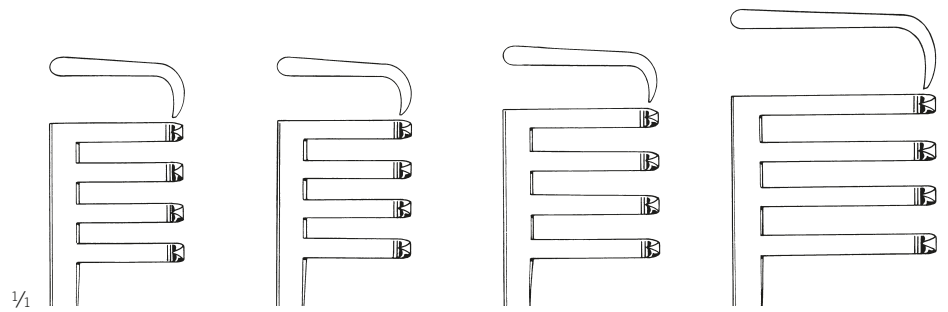

scharf sharp agudo pointu acuto	15-770-13-07	15-770-16-07	15-770-20-07	15-770-26-07
	14 cm / 5 4/8"	16,5 cm / 6 4/8"	21 cm / 8 2/8"	24,5 cm / 9 5/8"
	<b>81 mm</b>	<b>90 mm</b>	<b>135 mm</b>	<b>135 mm</b>
	<b>3:4</b>	<b>3:4</b>	<b>3:4</b>	<b>3:4</b>

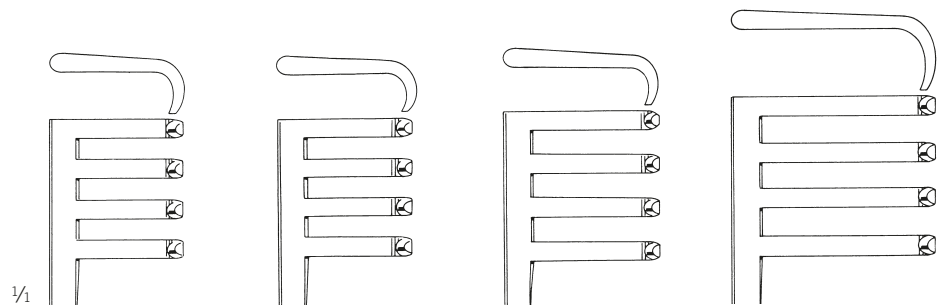

stumpf blunt romo mousse smusso	15-771-13-07	15-771-16-07	15-771-20-07	15-771-26-07
	14 cm / 5 4/8"	16,5 cm / 6 4/8"	21 cm / 8 2/8"	24,5 cm / 9 5/8"
	<b>81 mm</b>	<b>90 mm</b>	<b>135 mm</b>	<b>135 mm</b>
	<b>3:4</b>	<b>3:4</b>	<b>3:4</b>	<b>3:4</b>



1/2

Adson  
15-770-13-07 -  
15-772-26-07

## Wundspreizer, selbsthaltend

Wound Spreaders, self-retaining

Separadores autoestáticos

Ecarteurs autostatiques

Divaricatori autostatici

## Wundhaken, Halte- und Spreizsysteme

Retractors, Holding and spreading systems

Separadores, Sistemas de sujeción y dispersión

Ecarteurs, Systèmes de maintien et d'épandage

Divaricatori, Sistemi di tenuta e diffusione

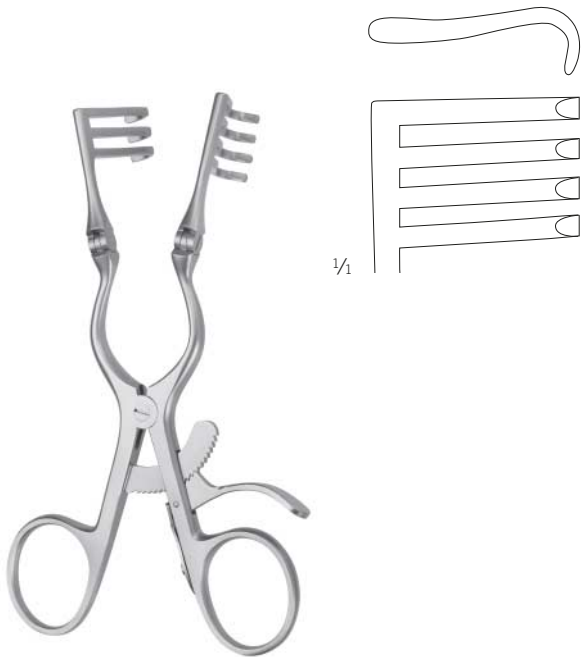

Adson  
15-773-13-07

14 cm / 5 4/8"

stumpf

blunt

romo

mousse

smusso



3:4



60 mm



## Wundspreizer, selbsthaltend, Valven

Wound Spreaders, self-retaining, blades

Separadores autoestáticos, valvas

Ecarteurs autostatiques, valves

Divaricatori autostatici, valve



1/2

Valven, gezahnt, Paar  
Blades, toothed, pair  
Valvas, dentado, par  
Valves, dentelé, paire  
Valve, dentate, paio

4 cm / 1 5/8" 15-774-40-07

4,5 cm / 1 6/8" 15-774-45-07

5 cm / 2" 15-774-50-07

5,5 cm / 2 1/8" 15-774-55-07

6 cm / 2 3/8" 15-774-60-07



15-774-00-07 & 15-774-25-07



1/2

Cloward

15-774-00-07

komplett mit je 2 Steckvalven  
Art.-Nr. 15-774-40-07 - 15-774-60-07

with 2 each plug-in blades  
ref. 15-774-40-07 - 15-774-60-07

con 2 valvas enchufables de c.u.  
ref. 15-774-40-07 - 15-774-60-07

chacun avec 2 valves interchangeables  
réf. 15-774-40-07 - 15-774-60-07

con 2 valve ad innesto  
rif. 15-774-40-07 - 15-774-60-07

15-774-25-07

25 cm / 9 7/8"

Sperrer allein  
Spreader only  
Separador solo  
Ecarteur seul  
Divaricatore solo



1/2

Valven, glatt, Paar  
Blades, smooth, pair  
Valvas, liso, par  
Valves, lisse, paire  
Valve, lisce, paio

4 cm / 1 5/8" 15-775-40-07

4,5 cm / 1 6/8" 15-775-45-07

5 cm / 2" 15-775-50-07

5,5 cm / 2 1/8" 15-775-55-07

6 cm / 2 3/8" 15-775-60-07



15-775-00-07 & 15-775-15-07



1/2

Cloward

15-775-00-07

komplett mit je 2 Steckvalven  
Art.-Nr. 15-775-40-07 - 15-775-60-07

with 2 each plug-in blades  
ref. 15-775-40-07 - 15-775-60-07

con 2 valvas enchufables de c.u.  
ref. 15-775-40-07 - 15-775-60-07

chacun avec 2 valves interchangeables  
réf. 15-775-40-07 - 15-775-60-07

con 2 valve ad innesto  
rif. 15-775-40-07 - 15-775-60-07

15-775-15-07

15 cm / 5 7/8"

Sperrer allein  
Spreader only  
Separador solo  
Ecarteur seul  
Divaricatore solo

## Wundspreizer, selbsthaltend

Wound Spreaders, self-retaining

Separadores autoestáticos

Ecarteurs autostatiques

Divaricatori autostatici

## Wundhaken, Halte- und Spreizsysteme

Retractors, Holding and spreading systems

Separadores, Sistemas de sujeción y dispersión

Ecarteurs, Systèmes de maintien et d'épandage

Divaricatori, Sistemi di tenuta e diffusione



1/2

Beckmann  
15-776-31-07

32 cm / 12 5/8"

stumpf

blunt

romo

mousse

smusso



4:4

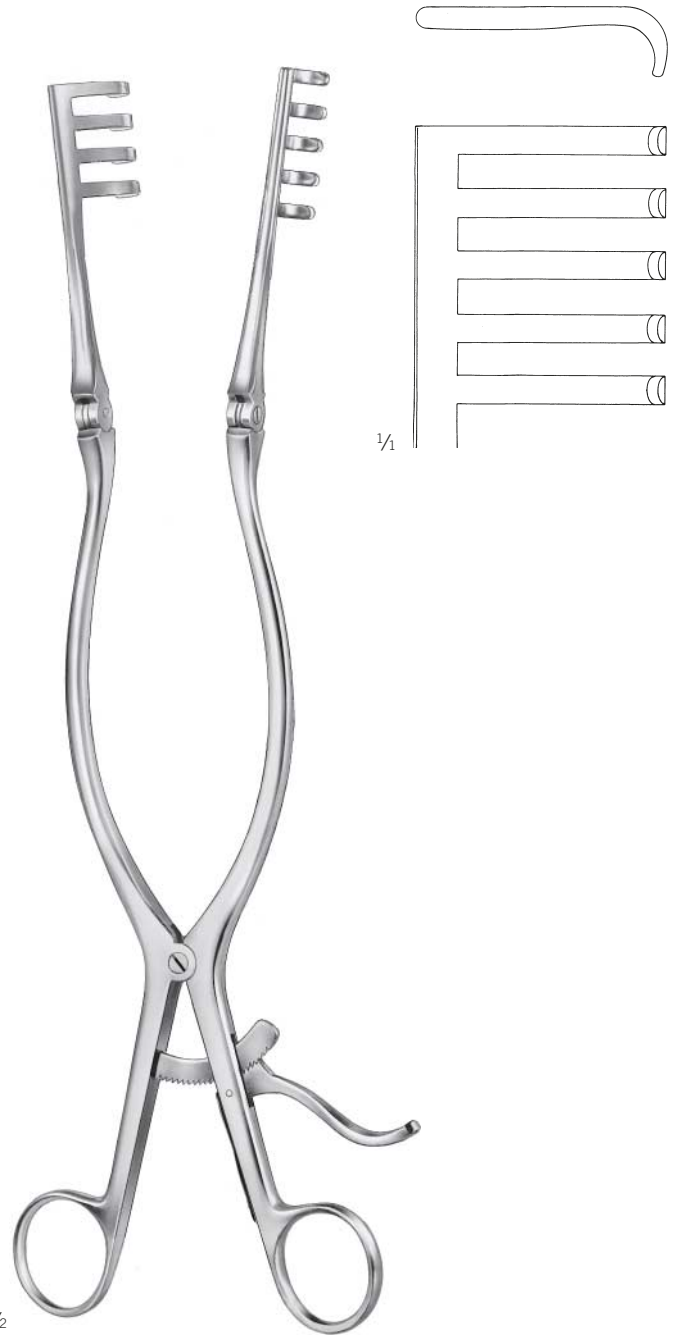

1/2

Adson  
15-777-32-07

33 cm / 13"

stumpf

blunt

romo

mousse

smusso



4:5

## Wundspreizer, selbsthaltend

Wound Spreaders, self-retaining

Separadores autoestáticos

Ecarteurs autostatiques

Divaricatori autostatici



1/2

Beckman-Adson  
15-778-00-07 -  
15-778-03-07

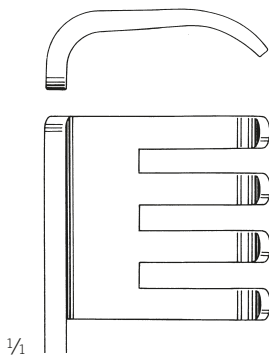

1/1

15-778-00-07

31 cm / 12 2/8"

stumpf  
blunt  
romo  
mousse  
smusso

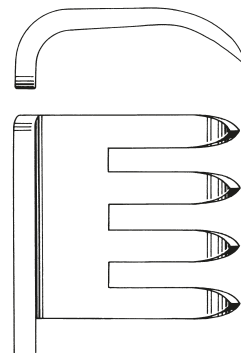

15-778-01-07

31 cm / 12 2/8"

scharf  
sharp  
agudo  
pointu  
acuto

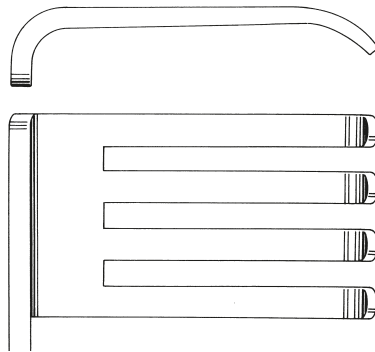

15-778-02-07

30,5 cm / 12 "

stumpf  
blunt  
romo  
mousse  
smusso

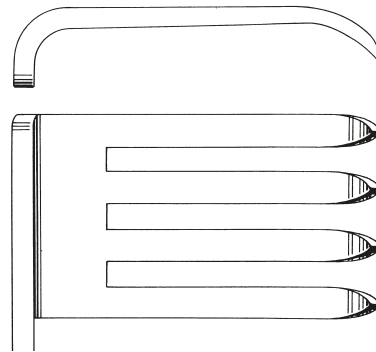

15-778-03-07

30,5 cm / 12 "

scharf  
sharp  
agudo  
pointu  
acuto



## Wundspreizer, selbthaltend

Wound Spreaders, self-retaining

Separadores autoestáticos

Ecarteurs autostatiques

Divaricatori autostatici

## Wundhaken, Halte- und Spreizsysteme

Retractors, Holding and spreading systems

Separadores, Sistemas de sujeción y dispersión

Ecarteurs, Systèmes de maintien et d'épandage

Divaricatori, Sistemi di tenuta e diffusione

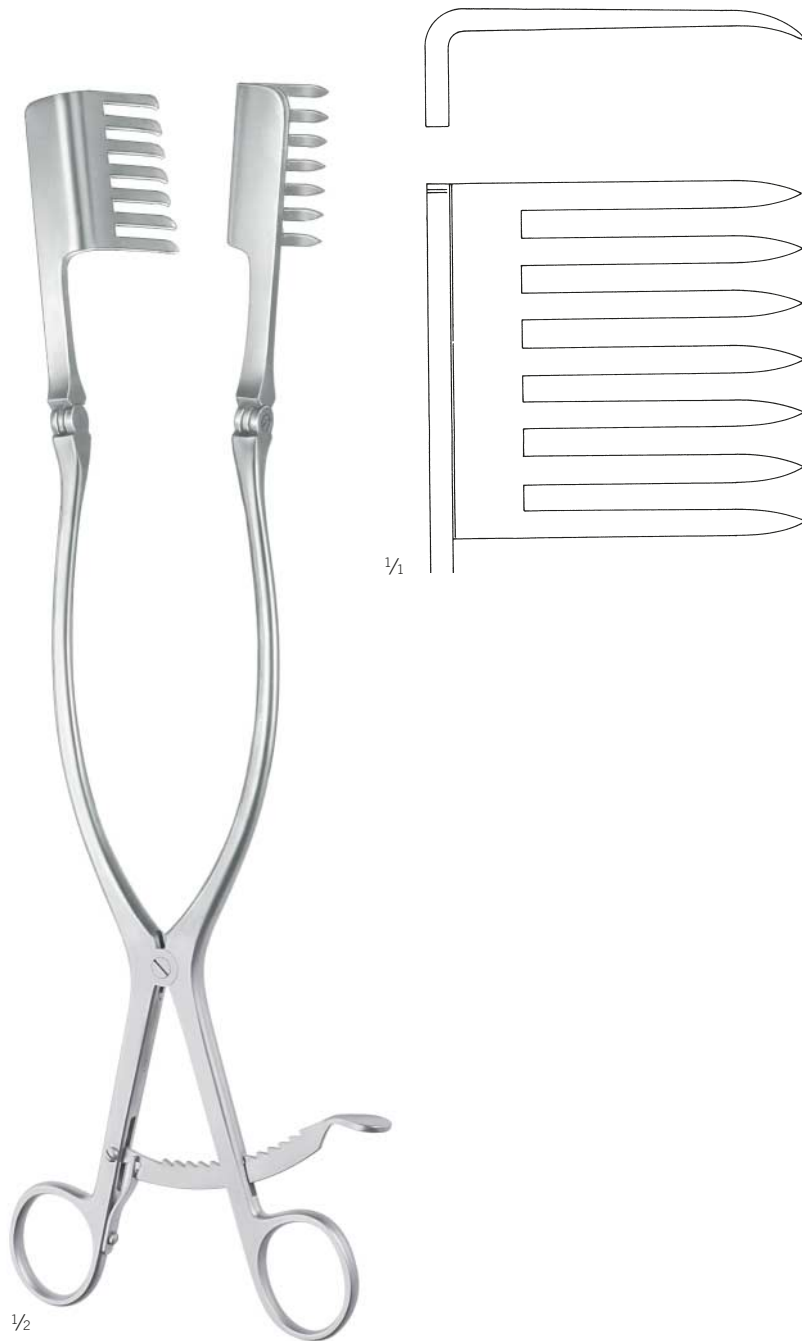

Beckman-Eaton  
15-778-32-07

32 cm / 12 5/8"

scharf  
sharp  
agudo  
pointu  
acuto



## Wundspreizer, selbsthaltend

Wound Spreaders, self-retaining

Separadores autoestáticos

Ecarteurs autostatiques

Divaricatori autostatici

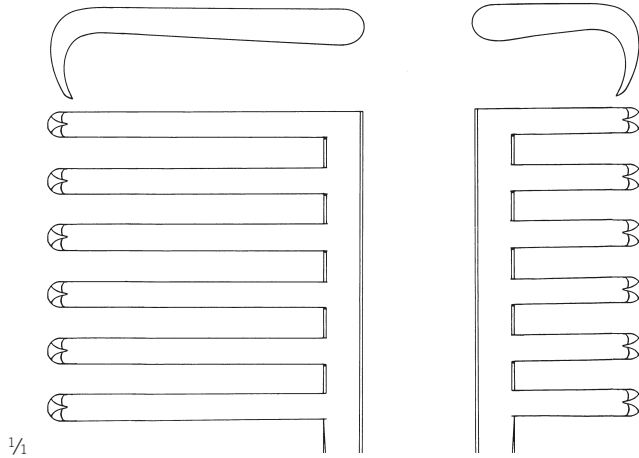

15-790-01-07

scharf, lange Zähne links  
sharp, long teeth on left side  
agudo, garfios largos a la izquierda  
pointu, griffes longues à gauche  
acuto, denti lunghi a sinistra



6:6



145 mm



1/2

Martin  
15-790-01-07 -  
15-790-02-07  
28,5 cm / 11 2/8"

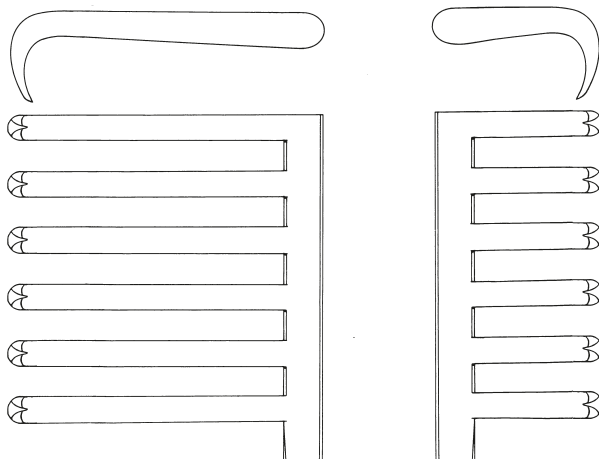

15-790-02-07

scharf, lange Zähne rechts  
sharp, long teeth on right side  
agudo, garfios largos a la derecha  
pointu, griffes longues à droite  
acuto, denti lunghi a destra



6:6



145 mm

## Wundspreizer, selbsthaltend

Wound Spreaders, self-retaining

Separadores autoestáticos

Ecarteurs autostatiques

Divaricatori autostatici

## Wundhaken, Halte- und Spreizsysteme

Retractors, Holding and spreading systems

Separadores, Sistemas de sujeción y dispersión

Ecarteurs, Systèmes de maintien et d'épandage

Divaricatori, Sistemi di tenuta e diffusione



Gelpi  
15-802-13-07  
13 cm / 5 1/8"

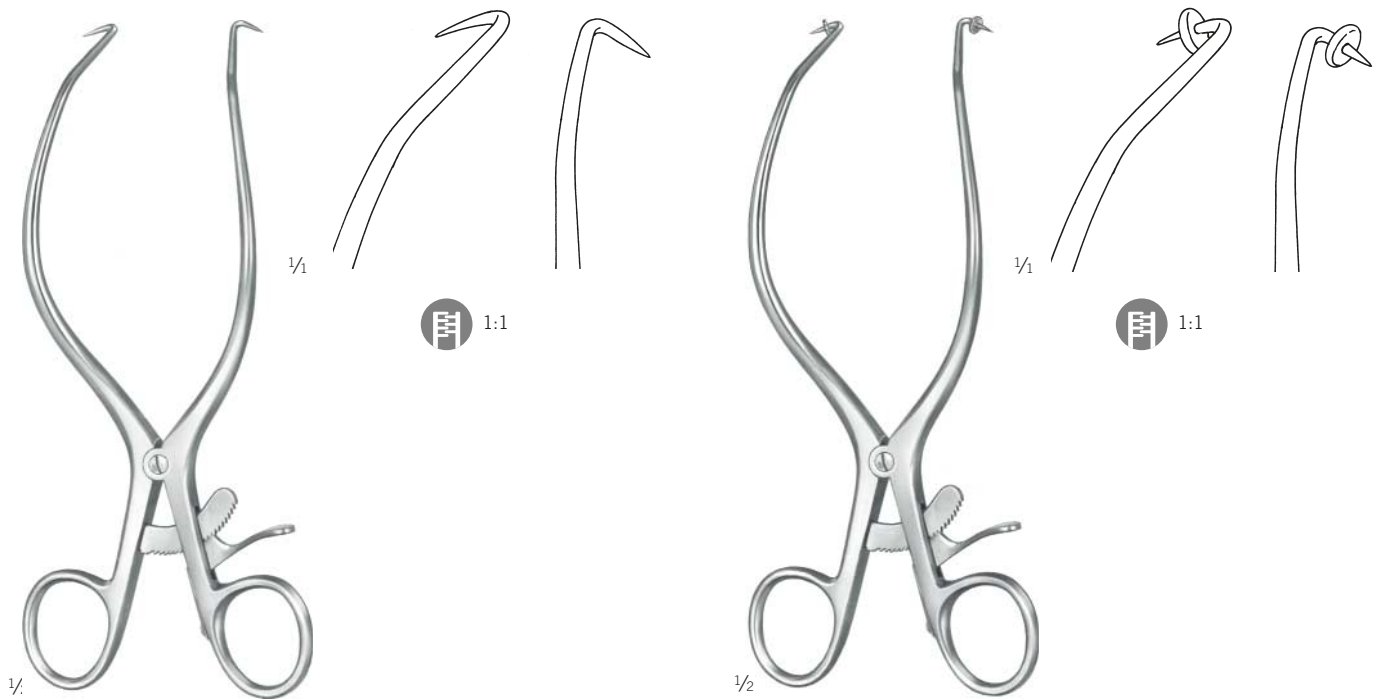

Gelpi  
15-802-18-07  
18 cm / 7 1/8"

Gelpi  
15-804-18-07  
18,5 cm / 7 3/8"

## Zervikales Wirbelkörper-Distraktionssystem

Cervical Vertebral Body Distraction System

Sistema de distractor para los cuerpos vertebrales cervicales

Système de distracteur cervicale

Sistema di distrattore cervicale

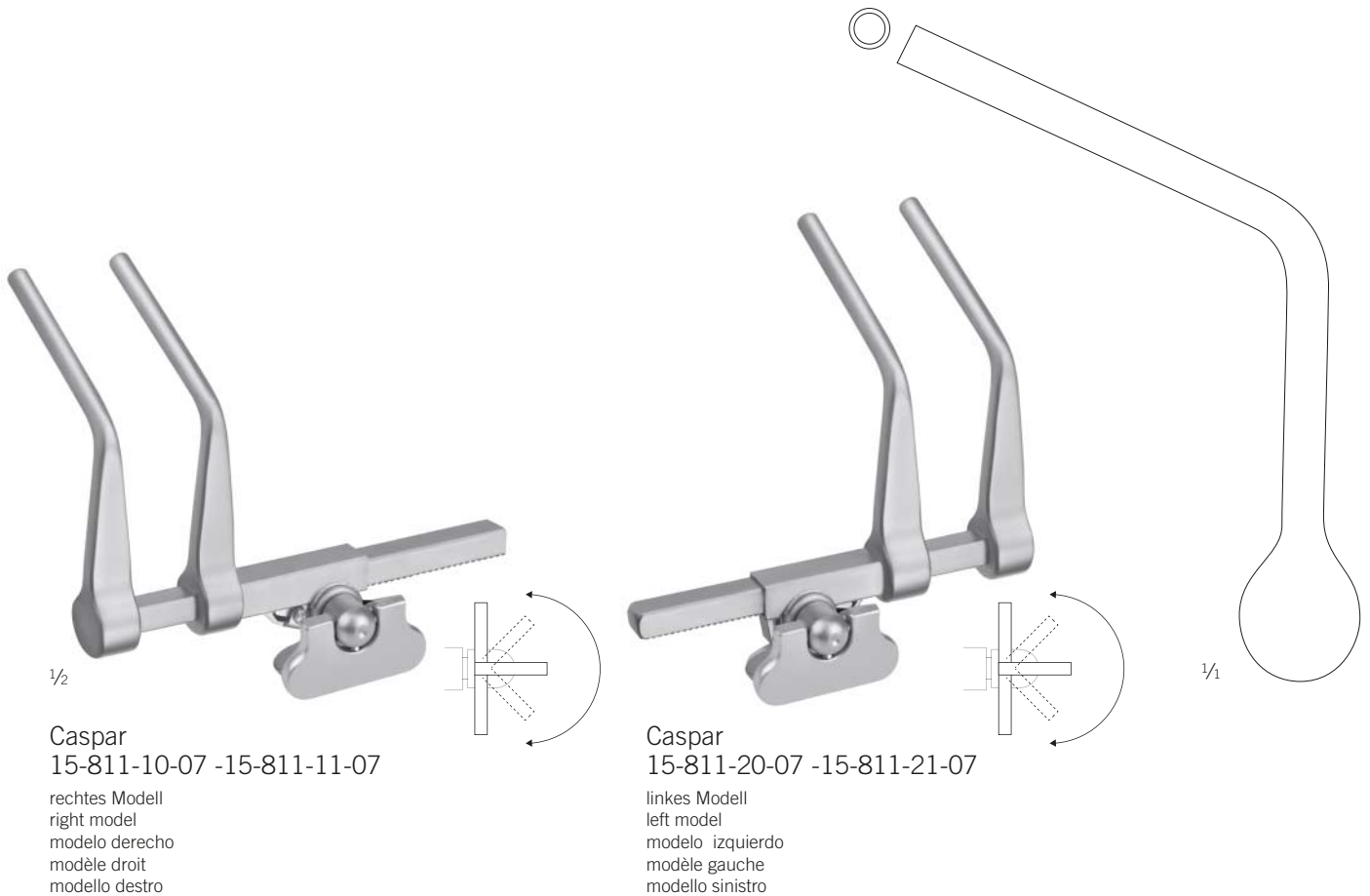

<b>Zervikaler Distraktor</b> <b>Cervical distractor</b> <b>Distractor cervical</b> <b>Distracteur cervicale</b> <b>Distrattore cervicale</b>	kurze Zahnstange short toothed rack cremallera corta crémaillère courte cremagliera corta	lange Zahnstange long toothed rack cremallera larga crémaillère longue cremagliera lunga
rechtes Modell right model modelo derecho modèle droit modello destro	15-811-10-07 11 cm / 4 3/8"	15-811-11-07 13 cm / 5 1/8"
linkes Modell left model modelo izquierdo modèle gauche modello sinistro	15-811-20-07 11 cm / 4 3/8"	15-811-21-07 13 cm / 5 1/8"

## Zervikales Wirbelkörper-Distraktionssystem

Cervical Vertebral Body Distraction System

Sistema de distractor para los cuerpos vertebrales cervicales

Système de distracteur cervicale

Sistema di distrattore cervicale

## Wundhaken, Halte- und Spreizsysteme

Retractors, Holding and spreading systems

Separadores, Sistemas de sujeción y dispersión

Ecarteurs, Systèmes de maintien et d'épandage

Divaricatori, Sistemi di tenuta e diffusione

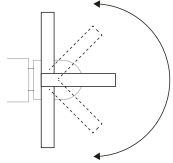

1/2

<b>Bohrbuchse</b> <b>Drillsocket</b> <b>Guía de broca</b> <b>Poignée guide-mèche</b> <b>Boccola di guida</b>	für zervikalen Distraktor for cervical distractor para distractor cervical pour distracteur cervicale per distrattore cervicale
rechtes Modell right model modelo derecho modèle droit modello destro	15-811-30-07 20 cm / 7 7/8"
linkes Modell left model modelo izquierdo modèle gauche modello sinistro	15-811-31-07 20 cm / 7 7/8"

Caspar  
15-811-30-07 - 15-811-31-07



1/2

Caspar  
15-811-40-07

23 cm / 9"

Schraubendreher für zervikale Distraktion (Silikongriff)  
Screw driver for cervical distraction (silicone handle)  
Destornillador para distracción cervical (mango silicona)  
Tournevis pour distracteur cervical (manche silicone)  
Cacciavite per distrazione cervicale (manico silicone)



1/2

12 mm	15-811-50-07
14 mm	15-811-51-07
16 mm	15-811-52-07
18 mm	15-811-53-07

Caspar  
15-811-50-07 - 15-811-53-07

Ø 8 mm

Schraube für zervikale Distraktion  
Screw for cervical distraction  
Tornillo para distracción cervical  
Vis pour distraction cervicale  
Vite per distrazione cervicale



1/2

14 mm	15-811-60-07
8 mm	15-811-61-07

Caspar  
15-811-60-07 - 15-811-61-07

Ø 8 mm

Bohrer für zervikale Distraktion  
Drill for cervical distraction  
Broca para distracción cervical  
Mèche pour distraction cervicale  
Punta per distrazione cervicale



## Instrumente für die lumbale Diskektomie

Instruments for lumbar Discectomy

Instrumentos para la disectomía lumbar

Instrumentes pour la disectomie lumbaire

Strumentario per discectomia lombare



Caspar

15-813-40-07 - 15-813-85-07

15 cm / 5 7/8"

Diskektomie-Spekulum

Discectomy-speculum

Espéculo de discectomía

Spéculum discectomie

Speculum per discectomia

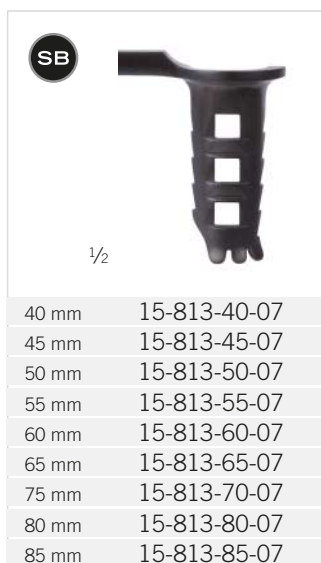

40 mm	15-813-40-07
45 mm	15-813-45-07
50 mm	15-813-50-07
55 mm	15-813-55-07
60 mm	15-813-60-07
65 mm	15-813-65-07
75 mm	15-813-70-07
80 mm	15-813-80-07
85 mm	15-813-85-07

## Instrumente für die lumbale Diskektomie

Instruments for lumbar Discectomy

Instrumentos para la disectomía lumbar

Instrumentes pour la disectomie lumbaire

Strumentario per discectomia lombare

## Wundhaken, Halte- und Spreizsysteme

Retractors, Holding and spreading systems

Separadores, Sistemas de sujeción y dispersión

Ecarteurs, Systèmes de maintien et d'épandage

Divaricatori, Sistemi di tenuta e diffusione



Caspar  
15-814-10-07

Diskektomie-Gegensperrer  
Counter retractor for discectomy  
Contrarretractor para discectomía  
Contre-rétracteur pour discectomie  
Contro-retrattore per discectomia

SB

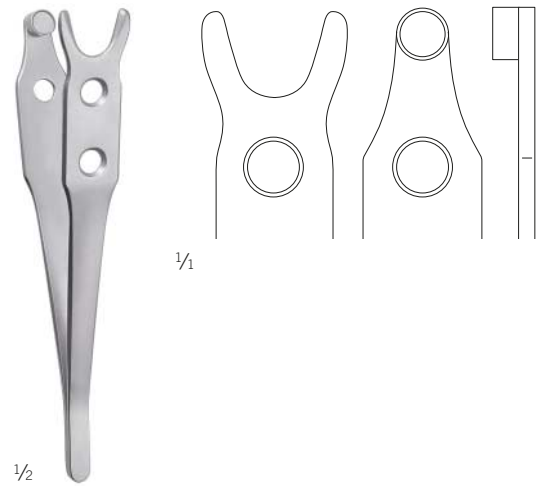

Caspar  
15-814-99-07

12 cm / 4 5/8"

Pinzette zum Austausch von Valven  
Forceps for the change of blades  
Pinzas para cambiar las valvas  
Pince pour changer les valves  
Pinze per sostituzione valve

➔ 15-814-10-07



SB

Valven, medial  
Blades, medial  
Valvas, mediales  
Valves, médiales  
Valve, mediali

40 mm	15-814-20-07
45 mm	15-814-21-07
50 mm	15-814-22-07
55 mm	15-814-23-07
60 mm	15-814-24-07
65 mm	15-814-25-07
70 mm	15-814-26-07
75 mm	15-814-27-07

➔ 15-814-10-07



SB

Valven, lateral  
Blades, lateral  
Valvas, laterales  
Valves, latérales  
Valve, laterali

35 mm	15-814-40-07
40 mm	15-814-41-07
45 mm	15-814-42-07
50 mm	15-814-43-07
55 mm	15-814-44-07
60 mm	15-814-45-07
65 mm	15-814-46-07
75 mm	15-814-47-07
80 mm	15-814-48-07
85 mm	15-814-49-07

➔ 15-814-10-07

## Wundspreizer für die zervikale Wirbelsäule

Retractors for cervical vertebral column

Separadores para la columna cervical

Ecarteurs pour colonne cervicale

Divaricatori per colonna cervicale

Arbeitsenden  
Working end  
El extremo funcional del producto  
Extrémité opératoire du produit  
L'estremità funzionale del prodotto

Ti

SB



Caspar  
15-901-01-07

Retraktor, zervikal  
Cervical base retractor  
Retractor cervical básico  
Rétracteur cervical de base  
Retrattore cervicale di base

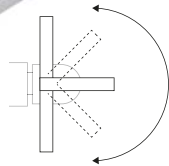

Ti SB



Caspar  
15-901-02-07

Gegensperrer, längs  
Cervical base counter retractor  
Contrarretractor cervical básico  
Contre-rétracteur cervical de base  
Contro-retrattore cervicale di base

Ti SB



Caspar  
15-901-03-07

Gegensperrer, längs  
Cervical base counter retractor  
Contrarretractor cervical básico  
Contre-rétracteur cervical de base  
Contro-retrattore cervicale di base

Ti SB

## Valven für die zervikale Wirbelsäule

Blades for cervical vertebral column

Valvas para la columna cervical

Valves pour colonne cervicale

Valve per colonna cervicale

## Wundhaken, Halte- und Spreizsysteme

Retractors, Holding and spreading systems

Separadores, Sistemas de sujeción y dispersión

Ecarteurs, Systèmes de maintien et d'épandage

Divaricatori, Sistemi di tenuta e diffusione



Ti	Valven, medial-lateral Blades, medial-lateral Valvas, medial-lateral Valves, médio-latérale Valve, mediale-laterale
19 x 25 mm	15-901-11-09
19 x 30 mm	15-901-12-09
19 x 35 mm	15-901-13-09
19 x 40 mm	15-901-14-09
19 x 45 mm	15-901-15-09
19 x 50 mm	15-901-16-09
19 x 55 mm	15-901-17-09
19 x 60 mm	15-901-18-09

Ti	Valven, lateral Blades, lateral Valvas, lateral Valves, latérale Valve, laterale
24 x 30 mm	15-901-21-09
24 x 35 mm	15-901-22-09
24 x 40 mm	15-901-23-09
24 x 45 mm	15-901-24-09
24 x 50 mm	15-901-25-09
24 x 55 mm	15-901-26-09
24 x 60 mm	15-901-27-09
24 x 65 mm	15-901-28-09
24 x 70 mm	15-901-29-09

Ti	Valven, medial Blades, medial Valvas, mediales Valves, médiales Valve, mediale
24 x 30 mm	15-901-31-09
24 x 35 mm	15-901-32-09
24 x 40 mm	15-901-33-09
24 x 45 mm	15-901-34-09
24 x 50 mm	15-901-35-09
24 x 55 mm	15-901-36-09
24 x 60 mm	15-901-37-09
24 x 65 mm	15-901-38-09
24 x 70 mm	15-901-39-09

➔ 15-901-01-07,  
15-901-02-07,  
15-901-03-07

➔ 15-901-01-07,  
15-901-02-07,  
15-901-03-07

➔ 15-901-01-07,  
15-901-02-07,  
15-901-03-07

Ti	Valven, longitudinal, stumpf Blades, longitudinal, blunt Valvas, longitudinal, romo Valves, longitudinal, emousse Valve, longitudinales, mussa
19 x 25 mm	15-901-41-09
19 x 30 mm	15-901-42-09
19 x 35 mm	15-901-43-09
19 x 40 mm	15-901-44-09
19 x 45 mm	15-901-45-09
19 x 50 mm	15-901-46-09
19 x 55 mm	15-901-47-09
19 x 60 mm	15-901-48-09

Ti	Valven, longitudinal, stumpf Blades, longitudinal, blunt Valvas, longitudinal, romo Valves, longitudinal, emousse Valve, longitudinales, mussa
24 x 35 mm	15-901-51-09
24 x 40 mm	15-901-52-09
24 x 45 mm	15-901-53-09
24 x 50 mm	15-901-54-09
24 x 55 mm	15-901-55-09
24 x 60 mm	15-901-56-09
24 x 65 mm	15-901-57-09
24 x 70 mm	15-901-58-09
24 x 75 mm	15-901-59-09

➔ 15-901-01-07,  
15-901-02-07,  
15-901-03-07

➔ 15-901-01-07,  
15-901-02-07,  
15-901-03-07



## Wundspreizer für die lumbale Wirbelsäule

Retractors for for lumbal Column

Separadores para la columna lumbar

Instruments pour colonne lumbaire

Strumentario per colonna lombare



1/2

Caspar  
15-902-01-07

Retraktor, lumbal

Lumbal base retractor

Retractor lumbar básico

Rétracteur lumbaire de base

Retrattore lombare di base



## Wundspreizer für die lumbale Wirbelsäule

Retractors for for lumbal Column  
 Separadores para la columna lumbar  
 Instruments pour colonne lumbaire  
 Strumentario per colonna lombare

## Wundhaken, Halte- und Spreizsysteme

Retractors, Holding and spreading systems  
 Separadores, Sistemas de sujeción y dispersión  
 Ecarteurs, Systèmes de maintien et d'épandage  
 Divaricatori, Sistemi di tenuta e diffusione



Ti

Valven, lumbal  
 Blades, lumbal  
 Valvas, lumbar  
 Valves, lumbaire  
 Valve, lombare

20 x 35 mm	15-902-11-09
20 x 40 mm	15-902-12-09
20 x 45 mm	15-902-13-09
20 x 55 mm	15-902-14-09
20 x 65 mm	15-902-15-09



Ti

Valven, lumbal  
 Blades, lumbal  
 Valvas, lumbar  
 Valves, lumbaire  
 Valve, lombare

40 x 35 mm	15-902-31-09
40 x 40 mm	15-902-32-09
40 x 45 mm	15-902-33-09
40 x 55 mm	15-902-34-09
40 x 65 mm	15-902-35-09
40 x 75 mm	15-902-36-09



Ti

Valven, lumbal  
 Blades, lumbal  
 Valvas, lumbar  
 Valves, lumbaire  
 Valve, lombare

60 x 35 mm	15-902-51-09
60 x 40 mm	15-902-52-09
60 x 45 mm	15-902-53-09
60 x 55 mm	15-902-54-09
60 x 65 mm	15-902-55-09
60 x 75 mm	15-902-56-09
60 x 85 mm	15-902-57-09

➔ 15-902-01-07

➔ 15-902-01-07

➔ 15-902-01-07



Ti

Hemi-Laminektomie-Haken, klein  
 Hemi laminectomy hook, small  
 Hemi gancho para laminectomía, pequeño  
 Hemi crochet pour laminectomie, petit  
 Hemi uncino per laminectomia, piccolo

15-902-21-09



Ti

Hemi-Laminektomie-Haken, groß  
 Hemi laminectomy hook, large  
 Hemi gancho para laminectomía, grande  
 Hemi crochet pour laminectomie, grand  
 Hemi uncino per laminectomia, grande

15-902-41-09

➔ 15-902-01-07

➔ 15-902-01-07

## Instrumente für die zervikale Wirbelsäule

Instruments for cervical vertebral column

Instrumentos para la columna cervical

Instrumentes pour colonne cervicale

Instrumentario per colonna cervicale

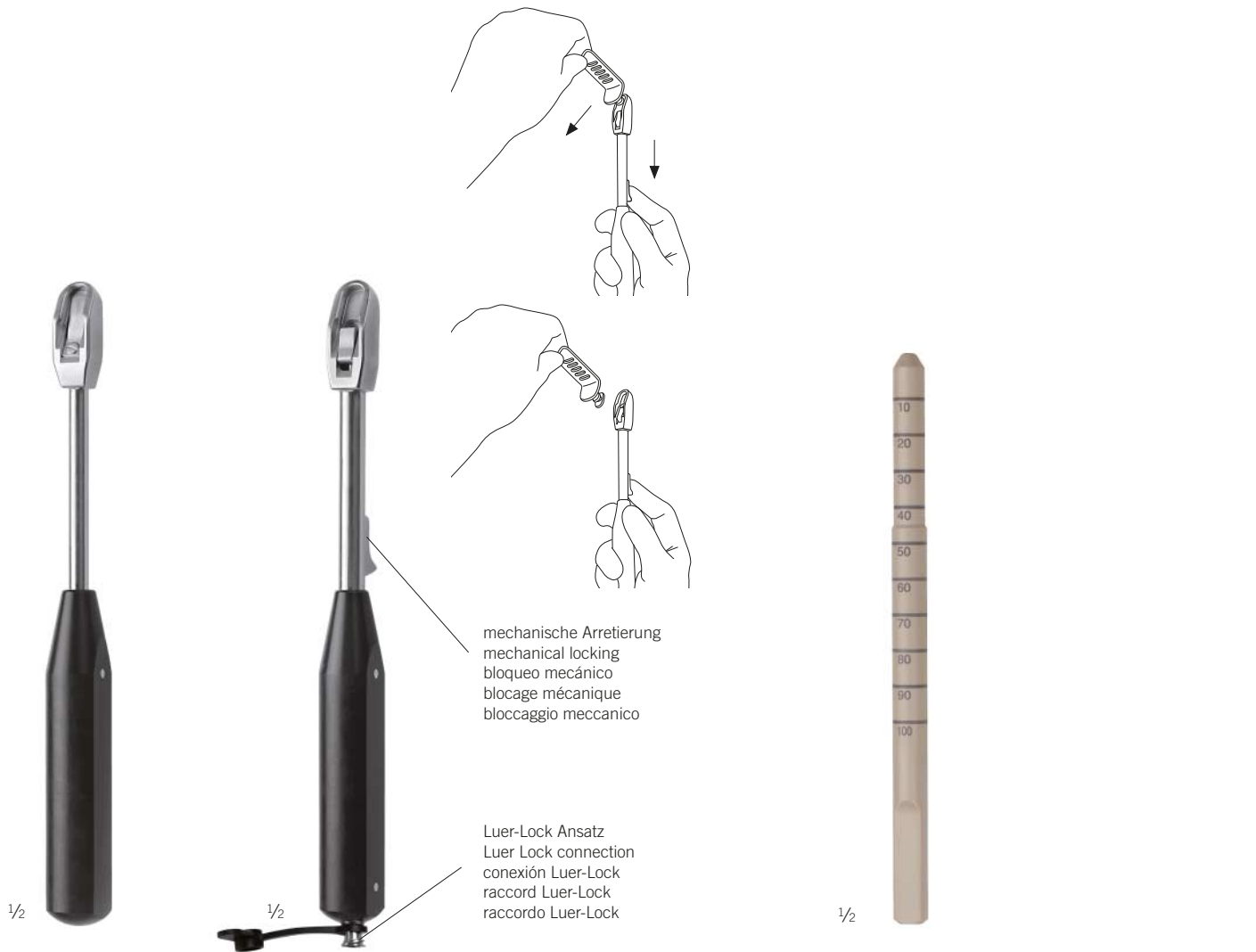

Caspar  
15-903-01-07

19 cm / 7 <sup>4</sup>/<sub>8</sub>"

Handgriff  
Handle  
Mango  
Poignée  
Impugnatura

Caspar  
15-903-02-07

19 cm / 7 <sup>4</sup>/<sub>8</sub>"

Handgriff mit Luer-Lock-Ansatz und Schutzkappe  
Handle with Luer Lock connection and protection cap  
Mango con conexión Luer-Lock y caperuza protectora  
Poignée avec raccord Luer-Lock et capuchon protecteur  
Impugnatura con raccordo Luer-Lock e calotta protettiva

Caspar  
15-903-03-04

17 cm / 6 <sup>6</sup>/<sub>8</sub>"

Messstab für zervikales Retraktorsystem  
Measurement handle for cervical retractor system  
Varilla de medición para el sistema de retracción cervical  
Jauge pour système de rétracteur cervical  
Asta di misurazione per sistema retrattore cervicale

## Laminectomiesperrer

Laminectomy Retractors  
Separadores para laminectomía  
Ecarteurs pour laminectomie  
Divaricatori per laminectomia

## Wundhaken, Halte- und Spreizsysteme

Retractors, Holding and spreading systems  
Separadores, Sistemas de sujeción y dispersión  
Ecarteurs, Systèmes de maintien et d'épandage  
Divaricatori, Sistemi di tenuta e diffusione



1/2

Scoville  
15-906-00-07  
22 cm / 8 5/8"



190 mm



1/2

Scoville-Haverfield  
15-906-50-07  
22 cm / 8 5/8"

Rahmen allein, mit Gelenk  
frame only, with joint  
bastidor suelto, con articulación  
cadre seul, avec articulation  
telaio solo, con articolazione



190 mm



## Valven

Blades  
Valvas  
Valves  
Valve



1/2

15-906-01-07

5 cm / 2"

Hakenvalve, Stück  
Hook, piece  
Gancho, pieza  
Valve à griffes, pièce  
Uncino, pezzo

50 mm tief, stumpf  
50 mm deep, blunt  
50 mm de profundidad, romo  
profondeur 50 mm, mousse  
profondità 50 mm, smusso

➔ 15-906-00-07,  
15-906-50-07



15-906-02-07

7 cm / 2 6/8"

Hakenvalve, Stück  
Hook, piece  
Gancho, pieza  
Valve à griffes, pièce  
Uncino, pezzo

70 mm tief, stumpf  
70 mm deep, blunt  
70 mm de profundidad, romo  
profondeur 70 mm, mousse  
profondità 70 mm, smusso

➔ 15-906-00-07,  
15-906-50-07



15-906-06-07

5 cm / 2"

Hakenvalve, Stück  
Hook, piece  
Gancho, pieza  
Valve à griffes, pièce  
Uncino, pezzo

50 mm tief, spitz  
50 mm deep, sharp  
50 mm de profundidad, agudo  
profondeur 50 mm, pointu  
profondità 50 mm, acuto

➔ 15-906-00-07,  
15-906-50-07



15-906-07-07

7 cm / 2 6/8"

Hakenvalve, Stück  
Hook, piece  
Gancho, pieza  
Valve à griffes, pièce  
Uncino, pezzo

70 mm tief, spitz  
70 mm deep, sharp  
70 mm de profundidad, agudo  
profondeur 70 mm, pointu  
profondità 70 mm, acuto

➔ 15-906-00-07,  
15-906-50-07



1/2

15-906-11-07 -  
15-906-13-07

Blattvalven, Stück  
Blades, piece  
Valvas, pieza  
Valves, pièce  
Valve, pezzo

gezahnt  
toothed  
dentado  
dentelé  
dentato

15-906-11-07	60 x 25 mm
15-906-12-07	61 x 50 mm
15-906-13-07	86 x 25 mm

➔ 15-906-00-07,  
15-906-50-07



15-906-41-07 -  
15-906-44-07

Hakenvalve, Stück  
Hook, piece  
Valva, pieza  
Valve, pièce  
Valvola, pezzo

spitz  
sharp  
agudo  
pointu  
acuto

15-906-41-07	48 x 50 mm
15-906-42-07	64 x 50 mm
15-906-43-07	64 x 64 mm
15-906-44-07	80 x 57 mm

➔ 15-906-00-07,  
15-906-50-07



15-906-46-07 -  
15-906-47-07

Hakenvalve, Stück  
Hook, piece  
Valva, pieza  
Valve, pièce  
Valvola, pezzo

spitz  
sharp  
agudo  
pointu  
acuto

15-906-46-07	44 x 38 mm
15-906-47-07	67 x 44 mm

➔ 15-906-00-07,  
15-906-50-07

## Wirbelkörperspreizer

Lamina Spreaders

Separadores para cuerpos vertebrales

Ecarteurs pour corps vertébraux

Separatori per vertebre

## Wundhaken, Halte- und Spreizsysteme

Retractors, Holding and spreading systems

Separadores, Sistemas de sujeción y dispersión

Ecarteurs, Systèmes de maintien et d'épandage

Divaricatori, Sistemi di tenuta e diffusione



15-812-01-07

12,7 cm / 4 9/8"



15-812-21-07

**Wirbelkörperspreizer**

**Lamina Spreaders**

**Separadores para cuerpos vertebrales**

**Ecarteurs pour corps vertébraux**

**Separatori per vertebre**

lange Zahnstange  
long toothed rack  
cremallera larga  
crémaillère longue  
cremagliera lunga

3 Zähne  
3 teeth  
3 dientes  
3 dents  
3 denti

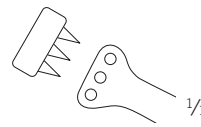

15-812-21-07

13 cm / 5 1/8"



Cloward  
24-973-16-07

16 cm / 6 3/8"

## Wirbelkörperspreizer

Lamina Spreaders

Separadores para cuerpos vertebrales

Ecarteurs pour corps vertébraux

Separatori per vertebre

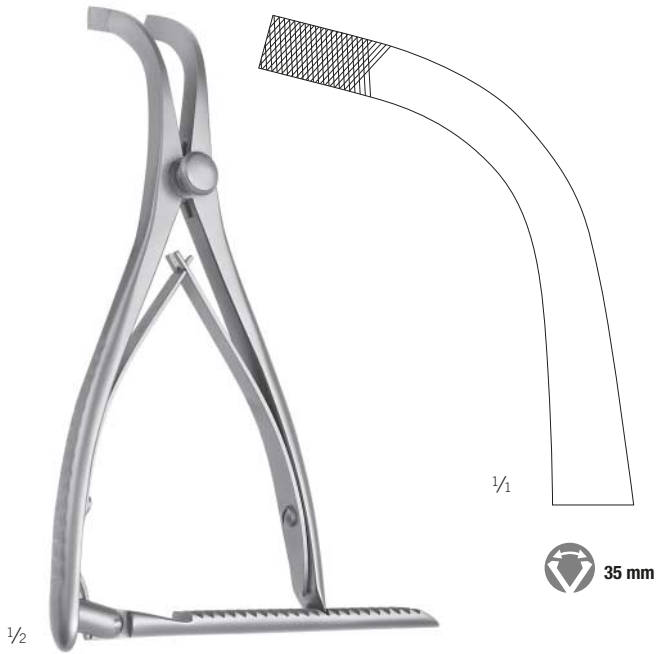

Inge  
24-974-17-07  
16 cm / 6 2/8"

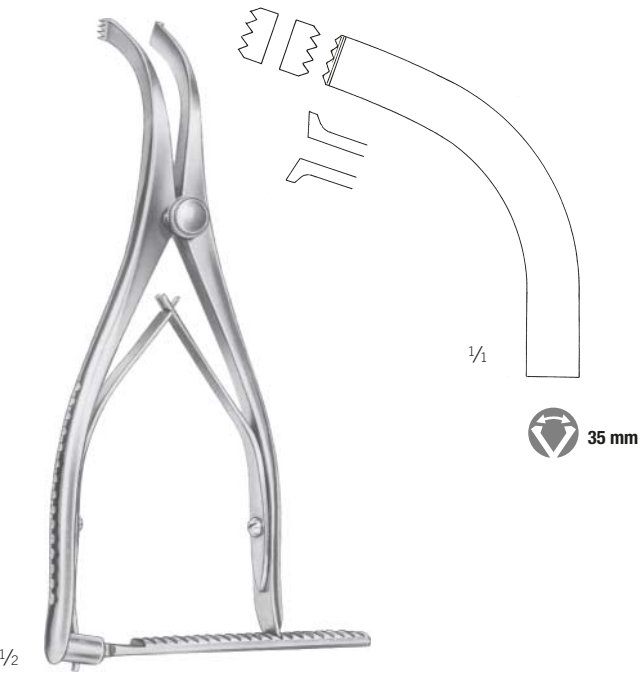

Inge  
24-975-17-07  
16 cm / 6 2/8"



Inge  
24-977-27-07  
25,5 cm / 10 "

## Schädelhalter

Skull Traction Tongs

Estribos de tracción craneal

Pinces de traction crânienne

Pinze per trazione craniale

## Wundhaken, Halte- und Spreizsysteme

Retractors, Holding and spreading systems

Separadores, Sistemas de sujeción y dispersión

Ecarteurs, Systèmes de maintien et d'épandage

Divaricatori, Sistemi di tenuta e diffusione



1/2

Crutchfield  
24-641-01-07

kleines Modell  
small pattern  
modelo pequeño  
modèle petit  
modello piccolo



1/2

Crutchfield  
24-641-02-07

mittleres Modell  
medium pattern  
modelo mediano  
modèle moyen  
modello medio



1/2

24-641-04-07

7 cm / 2 5/8"  
Vorböhrer  
Drill point  
Perforador  
Alésoir  
Alesatore  
3,5 mm Ø



24-641-05-07

7 cm / 2 5/8"  
Vorböhrer  
Drill point  
Perforador  
Alésoir  
Alesatore  
5 mm Ø



24-641-02-07



24-641-02-07



1/2

24-643-01-07

großes Modell  
large pattern  
modelo grande  
modèle grand  
modello grande

24-643-10-07

Ersatzdorn  
Spare pin  
Espina de repuesto  
Pointe de rechange  
Punta di ricambio



24-643-01-07

## Retraktoren zur Fixation am Schädel

Self-Retaining Retractors, for Skull Mounting

Separadores para la fijación del cráneo

Ecarteurs autofixants au crâne

Autofissatore per retrattori, per il supporto del cranio

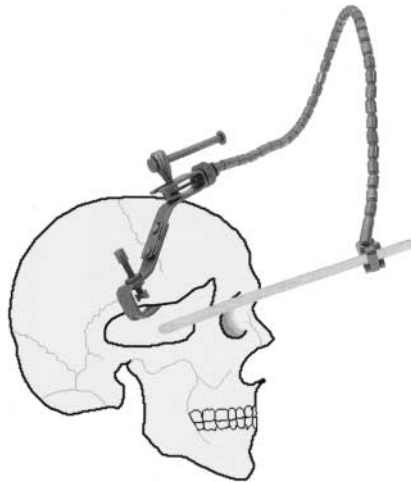

Leyla 24-702-01-07	Selbsthaltender Hirnspatel mit 1 Spannarm, komplett, bestehend aus:	Self-retaining brain retractor with 1 flexible arm, complete, consisting of:	Separador automático para el cerebro con 1 brazo, completo, compuesto de:	Ecarteur autofixant au crâne avec 1 bras complet, composé de:	Autofissatore per retrattore cervicale con 1 braccio, completo, composto da:
24-702-03-07	1 Spannarm, flexibel	Flexible arm	Brazo, flexible	Bras flexible	Braccio flessibile
24-702-04-07	1 Fixiervorrichtung für 1 Spannarm	Fixation base for 1 arm	Fijador para 1 brazo	Base de fixation pour 1 bras	Base di fissaggio per 1 braccio
24-702-08-07	1 Spatelhalter für flache Spatel	Support for flat brain spatulas	Porta-espátula para espátulas planas	Support pour spatules plats	Supporto per spatole cervicali piatte

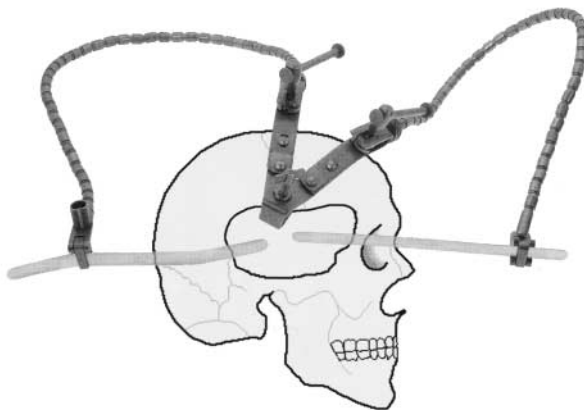

Leyla 24-702-02-07	Selbsthaltender Hirnspatel mit 2 Spannarmen, komplett, bestehend aus:	Self-retaining brain retractor with 2 arms, complete, consisting of:	Separador automático para el cerebro con 2 brazos, completo, compuesto de:	Ecarteur autofixant au crâne avec 2 bras complet, composé de:	Autofissatore per retrattore cervicale con 2 bracci, completo, composto da:
24-702-03-07	2 Spannarme, flexibel	Flexible arms	Brazos, flexibles	Bras, flexibles	Bracci, flessibili
24-702-05-07	1 Fixiervorrichtung für 2 Spannarme	Fixation base for 2 arms	Fijador para 2 brazos	Base de fixation pour 2 bras	Base di fissaggio per 2 bracci
24-702-08-07	2 Spatelhalter für flache Spatel	Supports for flat brain spatulas	Porta-espátulas para espátulas planas	Supports pour spatules plats	Supporti per spatole cervicali piatte

## Zubehör zu Leyla-Retraktoren

Accessories for Leyla Self Retaining Retractors  
Accesorios para separadores automáticos de Leyla  
Accessoires pour écarteurs autofixants de Leyla  
Accessori per autofissatori per retrattori di Leyla

## Wundhaken, Halte- und Spreizsysteme

Retractors, Holding and spreading systems  
Separadores, Sistemas de sujeción y dispersión  
Ecarteurs, Systèmes de maintien et d'épandage  
Divaricatori, Sistemi di tenuta e diffusione



Leyla  
24-702-03-07

Spannarm zum Aufstecken auf Kupplungsköpfe 24-702-15-07 / 24-702-16-07 und Fixiervorrichtungen 24-702-04-07 / 24-702-05-07 / 24-702-06-07

Flexible arm for attaching coupling heads 24-702-15-07 / 24-702-16-07 and fixation bases 24-702-04-07 / 24-702-05-07 / 24-702-06-07

Brazo para colocar sobre el acoplamiento 24-702-15-07 / 24-702-16-07 y los fijadores 24-702-04-07 / 24-702-05-07 / 24-702-06-07

Bras flexible pour fixation aux têtes d'accouplement 24-702-15-07 / 24-702-16-07 et base de fixation 24-702-04-07 / 24-702-05-07 / 24-702-06-07

Braccio flessibile per il fissaggio delle teste di accoppiamento 24-702-15-07 / 24-702-16-07 e le basi di fissaggio 24-702-04-07 / 24-702-05-07 / 24-702-06-07



Leyla  
24-702-04-07

Fixiervorrichtung für 1 Spannarm 24-702-03-07, zum Festschrauben am Schädel

Fixation base for 1 flexible arm 24-702-03-07, for skull mounting

Fijador para 1 brazo 24-702-03-07, para atornillar al cráneo

Base de fixation pour 1 bras 24-702-03-07, pour fixer au crâne

Base di fissaggio per 1 braccio flessibile 24-702-03-07, per il supporto del cranio



Leyla  
24-702-05-07

Fixiervorrichtung für 2 Spannarme 24-702-03-07, zum Festschrauben am Schädel

Fixation base for 2 flexible arms 24-702-03-07, for skull mounting

Fijador para 2 brazos 24-702-03-07, para atornillar al cráneo

Base de fixation pour 2 bras 24-702-03-07, pour fixer au crâne

Base di fissaggio per 2 bracci flessibili 24-702-03-07, per il supporto del cranio



Leyla  
24-702-06-07

Fixiervorrichtung für 1 Spannarm 24-702-03-07, zum Festschrauben an Rohrteilen bis Ø 16 mm

Fixation base for 1 flexible arm 24-702-03-07, for mounting to bars up to Ø 16 mm

Fijador para 1 brazo 24-702-03-07, para atornillar a tubos hasta Ø 16 mm

Base de fixation pour 1 bras 24-702-03-07, pour fixer aux tubes jusqu'à Ø 16 mm

Base di fissaggio per 1 braccio flessibile 24-702-03-07, per il supporto di asta di raccordo da Ø 16 mm



Leyla  
24-702-07-07

Spatelhalter mit Rundschaft bis Ø 5,5 mm, zur Befestigung am Spannarm 24-702-03-07

Support for brain spatulas with round shaft up to Ø 5.5 mm, fixation to flexible arm 24-702-03-07

Porta-espátula con vástago redondo hasta Ø 5,5 mm, para sujetarlo al brazo 24-702-03-07

Support pour spatules avec tiges ronds jusqu'à Ø 5,5 mm, pour fixation au bras 24-702-03-07

Supporto per spatole craniali con diametro asse Ø 5,5 mm, fissato al braccio flessibile 24-702-03-07



Leyla  
24-702-08-07

Spatelhalter für flache Spatel, zur Befestigung am Spannarm 24-702-03-07

Support for flat brain spatulas, fixation to flexible arm 24-702-03-07

Porta-espátula para espátulas planas, para sujetarlo al brazo 24-702-03-07

Support pour tiges plats, pour fixation au bras 24-702-03-07

Supporto per spatole cervicali piate, fissato al braccio flessibile 24-702-03-07

## Retraktoren zur Fixation am OP-Tisch

Self-Retaining Retractors, Fixation to Operating Table

Separadores para la fijación a la mesa de operaciones

Ecarteurs pour fixation à la table d'opération

Autofissatore per retrattori, da fissare alla tavola operatoria



Leyla 24-702-11-07	Selbsthaltender Hirnspatel mit 1 Spannarm, komplett, bestehend aus:	Self-retaining brain retractor with 1 flexible arm, complete, consisting of:	Separador automático para el cerebro con 1 brazo, completo, compuesto de:	Ecarteur du cerveau auto-fixant avec 1 bras complet, composé de:	Autofissatore per retrattori cervicali con 1 braccio flessibile, composto da:
24-702-03-07	1 Spannarm	Flexible arm	Brazo	Bras flexible	Braccio flessibile
24-702-07-07	1 Spatelhalterung für Spatel mit rundem Griff	Support, for brain spatulas with round shaft	Porta-espátula para espátulas con mangos redondos	Support pour spatules avec manches ronds	Supporto per spatole craniali con albero rotondo
24-702-13-07	1 Kugelgelenkkloben	Ball and socket joint	Articulación esférica	Articulation sphérique	Giunto a sfera ad incastro
24-702-14-07	1 Haltearm	Holding rod	Brazo de apoyo	Bras de fixation	Porta-asta
24-702-15-07	1 Kupplungskopf	Coupling head	Acoplamiento	Tête d'accouplement	Testa accoppiamento



Leyla 24-702-12-07	Selbsthaltender Hirnspatel mit 2 Spannarmen, komplett, bestehend aus:	Self-retaining brain retractor with 2 flexible arms, complete, consisting of:	Separador automático para el cerebro con 2 brazos, completo, compuesto de:	Ecarteur du cerveau auto-fixant avec 2 bras complet, composé de:	Autofissatore per retrattori cervicali con 2 bracci flessibili, composto da:
24-702-03-07	2 Spannarme	Flexible arms	Brazos	Bras flexibles	Bracci flessibili
24-702-07-07	1 Spatelhalterung, für flache Spatel	Support, for flat brain spatulas	Porta-espátula, para espátulas planas	Support pour spatules plats	Supporto per spatole craniali piatte
24-702-08-07	1 Spatelhalterung, für Spatel mit rundem Griff	Support, for brain spatulas with round shaft	Porta-espátula para espátulas con mangos redondos	Support pour spatules avec manches ronds	Supporto per spatole craniali con albero rotondo
24-702-13-07	1 Kugelgelenkkloben	Ball and socket joint	Articulación esférica	Articulation sphérique	Giunto a sfera ad incastro
24-702-14-07	1 Haltearm	Holding rod	Brazo de apoyo	Bras de fixation	Porta-asta
24-702-16-07	2 Kupplungsköpfe	Coupling heads	Acoplamientos	Têtes d'accouplement	Teste accoppiamento



## Zubehör zu Leyla-Retraktoren

Accessories for Leyla Retractors

Accesorios para separadores automáticos Leyla

Accessoires pour écarteurs de Leyla

Accessori per autofissatori per retrattori di Leyla

## Wundhaken, Halte- und Spreizsysteme

Retractors, Holding and spreading systems

Separadores, Sistemas de sujeción y dispersión

Ecarteurs, Systèmes de maintien et d'épandage

Divaricatori, Sistemi di tenuta e diffusione



### Leyla 24-702-13-07

Kugelgelenkkloben, zur Befestigung des Haltearms 24-702-14-07 an OP-Tisch-Schienen

Ball and socket joint, for fixation of holding rod 24-702-14-07 to pole of operating table

Articulación esférica, para sujetar el brazo de apoyo 24-702-14-07 sobre la mesa de operaciones

Articulation sphérique pour fixation du bras 24-702-14-07 aux bandes de la table d'opération

Giunto a sfera ad incastro, per il fissaggio dell'asta 24-702-14-07 all'estremità del tavolo operatorio

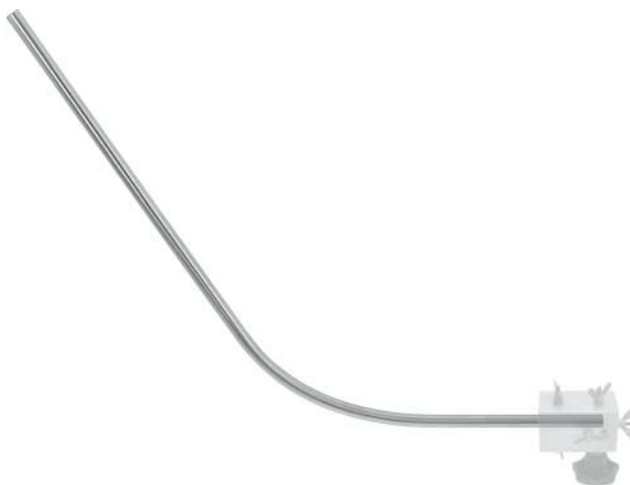

### Leyla 24-702-14-07

Haltearm zur Fixation im Kugelgelenkkloben 24-702-13-07 und zur Aufnahme der Kupplungsköpfe 24-702-15-07 / 24-702-16-07

Holding rod for fixation in ball and socket joint 24-702-13-07 and to take coupling heads 24-702-15-07 / 24-702-16-07

Brazo de apoyo para fijar en la articulación esférica 24-702-13-07 y para recoger los acoplamientos 24-702-15-07 / 24-702-16-07

Bras d'appui pour fixer dans l'articulation sphérique 24-702-13-07 pour prendre les têtes d'accouplement 24-702-15-07 / 24-702-16-07

Porta asta per il fissaggio al giunto a sfera 24-702-13-07 e per prendere le teste di accoppiamento 24-702-15-07 / 24-702-16-07



### Leyla 24-702-15-07

Kupplungskopf zur Aufnahme von 1-5 Spannarmen 24-702-03-07

Coupling head to take 1-5 flexible arms 24-702-03-07

Acoplamiento para sujetar 1-5 brazos 24-702-03-07

Tête d'accouplement pour prendre 1-5 bras flexibles 24-702-03-07

Testa accoppiamento per prendere 1-5 bracci flessibili 24-702-03-07



### Leyla 24-702-16-07

Kupplungskopf, drehbar, in allen Ebenen fixierbar, zur Aufnahme von 1 Spannarm 24-702-03-07

Coupling head, turnable, can be fixed in any position, to take 1 flexible arm 24-702-03-07

Acoplamiento, girable y se puede fijar en todas las posturas para sujetar un brazo 24-702-03-07

Tête d'accouplement, rotative, peut être fixée en toute position, pour tenir 1 bras flexible 24-702-03-07

Testa accoppiamento, girevole, può essere fissata in qualsiasi posizione, supporta 1 braccio flessibile 24-702-03-07



# Spatel

Spatulas  
Espátulas  
Spatules  
Spatole



15-975-13-01

20 cm / 7 7/8"

13 mm

15-975-16-01

20 cm / 7 7/8"

16 mm

1/2

## Martin

15-975-13-01 -  
15-975-16-01

biegsam, sehr weich  
malleable, very soft  
maleable, muy blando  
malléable, très souple  
malleabile, molto dolce



1/1

24-535-18-07

18,5 cm / 7 2/8"

24-535-21-07

21,5 cm / 8 4/8"

1/2

24-535-18-07 -  
24-535-21-07

Intimaspatel  
Intima Spatulas  
Espátulas para la íntima  
Spatules pour la tunique interne  
Spatole per intima

➔ 24-702-08-07



1/2

24-720-08-01	155 x 8 mm
24-720-11-01	155 x 11 mm
24-720-14-01	155 x 14 mm
24-720-17-01	155 x 17 mm

## Heifetz

24-720-08-01 -  
24-720-17-01

biegsam  
malleable  
maleable  
malléable  
malleabile

➔ 24-702-07-07



1/1

24-721-14-01	200 x 14 mm
24-721-17-01	200 x 17 mm
24-721-20-01	200 x 20 mm

## Heifetz

24-721-14-01 -  
24-721-20-01

biegsam  
malleable  
maleable  
malléable  
malleabile

➔ 24-702-07-07

Diagnostik  
Diagnostics  
Diagnóstico  
Diagnostic  
Diagnostica

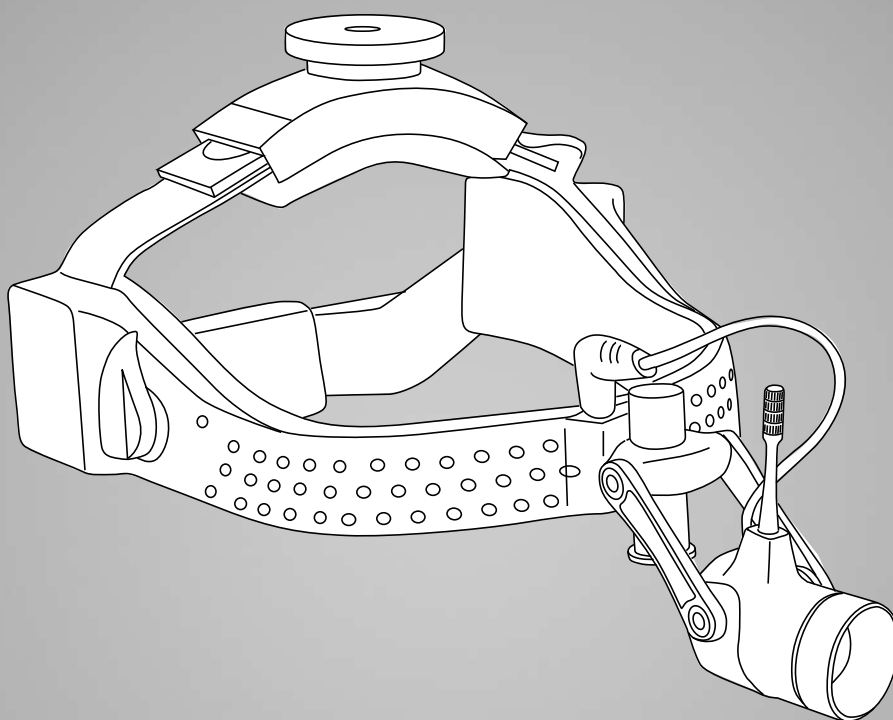

## Spezial-Produkte

Special Products

Produits spéciaux

Prodotti speciali

Productos especiales

Informationen zu den KLS-Martin-Stirnleuchten entnehmen Sie bitte der separaten Broschüre „MedLED Chrome“.

Please refer to the separate brochure for information about KLS-Martin headlights “MedLED Chrome”.

Encontrará información sobre las lámparas frontal de KLS-Martin en el folletos individual “MedLED Chrome”.

Veuillez vous reporter au brochure séparée pour obtenir des informations détaillées relatives aux lampes frontales «MedLED Chrome» .

Per informazioni sulle lampada frontale di KLS Martin, consultare le brochure separate KLS Martin “MedLED Chrome”.

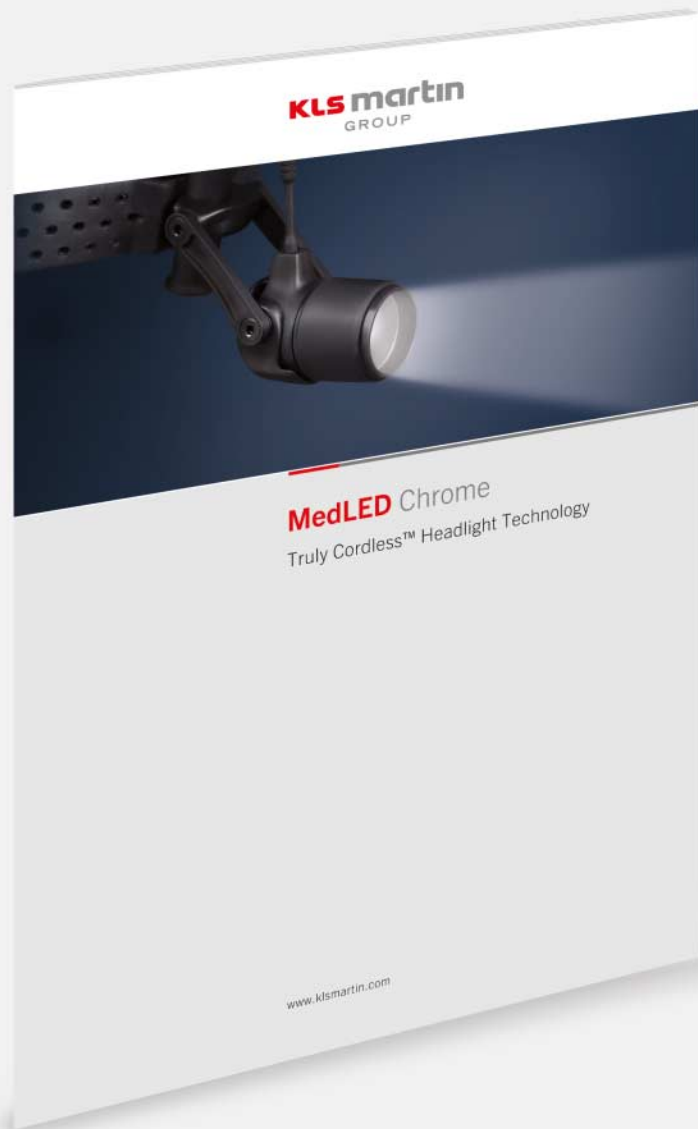
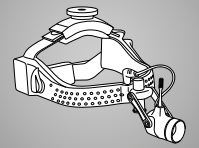



Sauger, Kanülen  
Suction Tubes, Cannulas  
Tubos de Aspiración, Cánulas  
Tubes d'aspiration, Canules  
Tubi d'aspirazione, Cannule

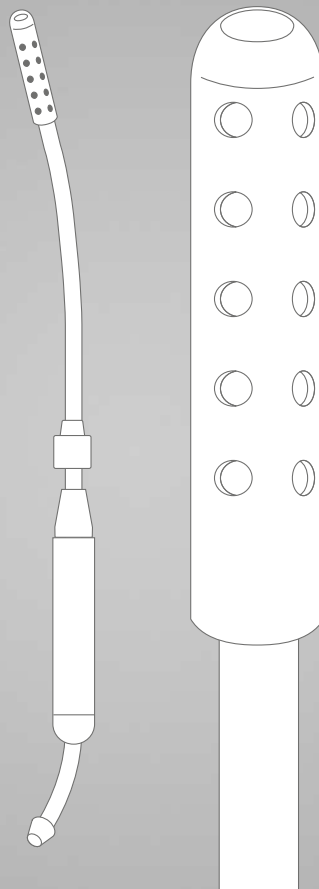

## Saugrohre

Suction Cannulas

Tubos de aspiración

Tubes d'aspiration

Tubi di aspirazione



	Arbeitslänge working length largo útil longueur utile lunghezza utile	
18-523-06-01	130 mm	Ø 2,0 mm
18-523-07-01	130 mm	Ø 2,3 mm
18-523-08-01	130 mm	Ø 2,7 mm
18-523-09-01	130 mm	Ø 3,0 mm
18-523-10-01	130 mm	Ø 3,3 mm
18-523-11-01	130 mm	Ø 3,6 mm
18-523-12-01	130 mm	Ø 4,0 mm
18-523-13-01	130 mm	Ø 5,0 mm

**Ø 4 mm**  
Adson  
18-521-21-01  
20 cm / 7 <sup>7</sup>/<sub>8</sub>"

**Ø 5 mm**  
Adson  
18-521-51-01  
20 cm / 7 <sup>7</sup>/<sub>8</sub>"

**Ø 3,3 mm**  
Frazier  
18-522-10-01  
24 cm / 9 <sup>4</sup>/<sub>8</sub>"

Frazier  
18-523-06-01 -  
18-523-13-01  
19,5 cm / 7 <sup>5</sup>/<sub>8</sub>"

## Saugrohre

Suction Cannulas  
Tubos de aspiración  
Tubes d'aspiration  
Tubi di aspirazione

## Sauger, Kanülen

Suction Tubes, Cannulas  
Tubos de Aspiración, Cánulas  
Tubes d'aspiration, Canules  
Tubi d'aspirazione, Cannule

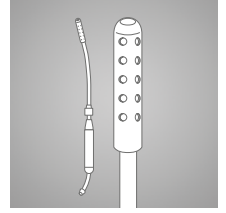

1/2

Fergusson  
18-524-15-01 -  
18-524-50-01  
18 cm / 7 1/8"

	Arbeitslänge working length largo útil longueur utile lunghezza utile	
18-524-15-01	110 mm	Ø 1,5 mm
18-524-20-01	110 mm	Ø 2,0 mm
18-524-25-01	110 mm	Ø 2,5 mm
18-524-30-01	110 mm	Ø 3,0 mm
18-524-40-01	110 mm	Ø 4,0 mm
18-524-50-01	110 mm	Ø 5,0 mm



1/2

Fergusson  
18-524-60-01 -  
18-524-65-01

	Arbeitslänge working length largo útil longueur utile lunghezza utile	
18-524-60-01	130 mm	Ø 1,5 mm
18-524-61-01	130 mm	Ø 2,0 mm
18-524-62-01	130 mm	Ø 2,5 mm
18-524-63-01	130 mm	Ø 3,0 mm
18-524-64-01	130 mm	Ø 4,0 mm
18-524-65-01	130 mm	Ø 5,0 mm



## Saugrohre

Suction Cannulas  
Tubos de aspiración  
Tubes d'aspiration  
Tubi di aspirazione



	Arbeitslänge working length largo útil longueur utile lunghezza utile	
18-524-70-01	160 mm	Ø 1,5 mm
18-524-71-01	160 mm	Ø 2,0 mm
18-524-72-01	160 mm	Ø 2,5 mm
18-524-73-01	160 mm	Ø 3,0 mm
18-524-74-01	160 mm	Ø 4,0 mm
18-524-75-01	160 mm	Ø 5,0 mm

Fergusson  
18-524-70-01 -  
18-524-75-01



	Arbeitslänge working length largo útil longueur utile lunghezza utile	
18-524-80-01	200 mm	Ø 1,5 mm
18-524-81-01	200 mm	Ø 2,0 mm
18-524-82-01	200 mm	Ø 2,5 mm
18-524-83-01	200 mm	Ø 3,0 mm
18-524-84-01	200 mm	Ø 4,0 mm
18-524-85-01	200 mm	Ø 5,0 mm

Fergusson  
18-524-80-01 -  
18-524-85-01

## Saugrohre

Suction Cannulas  
Tubos de aspiración  
Tubes d'aspiration  
Tubi di aspirazione

## Sauger, Kanülen

Suction Tubes, Cannulas  
Tubos de Aspiración, Cánulas  
Tubes d'aspiration, Canules  
Tubi d'aspirazione, Cannule

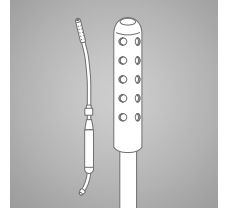

1/2

Poppen  
18-525-06-01 -  
18-525-12-01

	Arbeitslänge working length largo útil longueur utile lunghezza utile	
18-525-06-01	90 mm	Ø 2,0 mm
18-525-08-01	90 mm	Ø 2,6 mm
18-525-10-01	90 mm	Ø 3,3 mm
18-525-12-01	90 mm	Ø 4,0 mm

## Sauger, Saugrohre

Suction cannulas, Suction Tubes

Cánulas de aspiración, Tubos de aspiración

Canules d'aspiration, Tubes d'aspiration

Cannule di'aspirazione, Tubi di aspirazione



	Saugaufsatz Suction tip Punta de succión Pointe de succion Punta per aspirazione
18-526-05-01	Ø 0,5 mm
18-526-07-01	Ø 0,7 mm
18-526-09-01	Ø 0,9 mm
18-526-12-01	Ø 1,2 mm



1/2

Zoellner

18-526-00-01

Saugkanüle, allein

Suction cannula, only

Tubo de aspiración, solo

Tube d'aspiration, seul

Tubo di aspirazione, solo



1/2

Ø 2,3 mm

Wullstein

18-527-00-01

14 cm / 5 4/8"

komplett mit Griff und drei Aufsätzen  
complete, with handle and 3 tips  
completo, con mango y 3 puntas  
complet, avec manche et 3 pointes  
completo, con manico e 3 punte



1/1

18-527-04-01 Ø 0,4 mm

18-527-06-01 Ø 0,6 mm

18-527-08-01 Ø 0,8 mm

18-527-04-01 - 18-527-08-01

4,5 cm / 1 5/8"

Mikro-Saugkanüle

Micro suction cannula

Micro-tubo de aspiración

Micro-tube d'aspiration

Micro-tubo di aspirazione



18-527-00-01



1/2

Ø 2,5 mm

Wullstein

18-527-01-01

14 cm / 5 4/8"

Handgriff mit Rohr, allein  
Handle with tube, only  
Mango con tubo, solo  
Manche avec tube, seul  
Manico con tubo, solo

## Sauger, Saugrohre

Suction cannulas, Suction Tubes  
 Cánulas de aspiración, Tubos de aspiración  
 Canules d'aspiration, Tubes d'aspiration  
 Cannule di'aspirazione, Tubi di aspirazione

## Sauger, Kanülen

Suction Tubes, Cannulas  
 Tubos de Aspiración, Cánulas  
 Tubes d'aspiration, Canules  
 Tubi d'aspirazione, Cannule

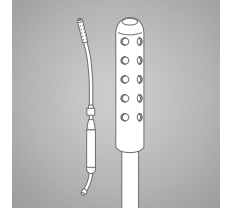

1/2

	Arbeitslänge working length largo útil longueur utile lunghezza utile	
18-528-10-01	75 mm	Ø 1,0 mm
18-528-15-01	75 mm	Ø 1,5 mm
18-528-20-01	75 mm	Ø 2,0 mm

## Baron-Schuknecht

18-528-10-01 -  
 18-528-20-01

mit Unterbrecher  
 with finger cut-off  
 con placa interruptor  
 avec plaque interrupteur  
 con placa interruttore



1/2

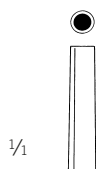

**Ø 3,0 mm**  
 18-529-30-07  
 16,5 cm / 6 4/8"  
 Arbeitslänge  
 working length  
 largo útil  
 longueur utile  
 lunghezza utile  
**110 mm**

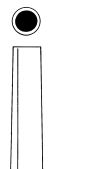

**Ø 3,5 mm**  
 18-529-35-07  
 16,5 cm / 6 4/8"  
 Arbeitslänge  
 working length  
 largo útil  
 longueur utile  
 lunghezza utile  
**110 mm**



**Ø 4,5 mm**  
 18-529-45-07  
 18 cm / 7 4/8"  
 Arbeitslänge  
 working length  
 largo útil  
 longueur utile  
 lunghezza utile  
**130 mm**



1/2

## Luer

18-529-30-07 -  
 18-529-45-07

konisch  
 conical  
 cónico  
 conique  
 conico

18-531-01-07

Saughandgriff für Tonsillenkanüle  
 Suction handle for tonsil cannula

Mango de aspiración para  
 cánula para amígdalas

Poignée d'aspiration pour  
 aiguille pour amygdales

Impugnatura di aspirazione  
 per cannula per tonsille

➔ 18-640-20-07,  
 18-641-20-07,  
 18-642-20-07

## Sauger, Saugrohre

Suction cannulas, Suction Tubes

Cánulas de aspiración, Tubos de aspiración

Canules d'aspiration, Tubes d'aspiration

Cannule di aspirazione, Tubi di aspirazione



**Ø 3,2 mm**  
Landolt  
18-533-01-07

25 cm / 9 7/8"

Sauger für Hypophyse  
Suction tube for pituitary  
Aspirador para pituitaria  
Tube d'aspiration pour hypophyse  
Tubo di aspirazione per ipofisi



Cerullo  
18-535-00-07

Saugventil  
Suction valve  
Válvula de aspiración  
Vanne d'aspiration  
Valvola di aspirazione



Yasargil  
18-540-15-01 -  
18-540-35-01

17 cm / 6 5/8"

	Arbeitslänge working length largo útil longueur utile lunghezza utile	
18-540-15-01	150 mm	Ø 1,5 mm
18-540-20-01	150 mm	Ø 2,0 mm
18-540-25-01	150 mm	Ø 2,5 mm
18-540-35-01	150 mm	Ø 3,5 mm

## Sauger

Suction Tubes  
Tubos de aspiración  
Tubes d'aspiration  
Tubi d'aspirazione

## Sauger, Kanülen

Suction Tubes, Cannulas  
Tubos de Aspiración, Cánulas  
Tubes d'aspiration, Canules  
Tubi d'aspirazione, Cannule

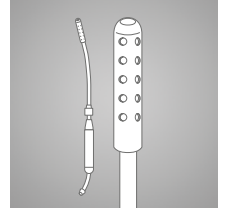

1/2

**Ø 8,0 mm**  
Baby-Yankauer  
18-542-21-01  
21 cm / 8 2/8"

1/2

**Ø 9,4 mm**  
Yankauer  
18-543-27-01  
31 cm / 12 2/8"  
komplett, mit Saugspitze  
und Schlaucholive  
complete, with suction tip  
and connector  
completo, con punta de succión  
et raccord  
complet, avec pointe de succion  
et raccord  
completi, con punte d'aspirazione  
e raccordo

1/2

**Ø 4,0 mm**  
De Bakey-Adson  
18-544-16-07  
16 cm / 6 2/8"

1/2

**Ø 4,0 mm**  
De Bakey-Adson  
18-544-20-07  
20 cm / 7 7/8"

1/2

**Ø 9,0 mm**  
De Bakey-Adson  
18-544-28-07  
28 cm / 6 2/8"

## Sauger

Suction Tubes

Tubos de aspiración

Tubes d'aspiration

Tubi d'aspirazione



Yankauer  
18-545-00-01

31 cm / 12 2/8"

komplett, mit Griff, 4 Saugrohren Fig. 0/1/2/3,  
Saugspitze und Schlaucholive

complete, with handle, 4 tubes fig. 0/1/2/3,  
suction tip and tube connector

completo, con mango, 4 tubos, fig. 0/1/2/3,  
punta de succión y conector para tubos

complet, avec manche, 4 tubes, fig. 0/1/2/3,  
pointe de succion et raccord ou tubes

completi, con manico, 4 tubi, fig. 0/1/2/3,  
punta per aspirazione e raccordo per tubi

18-545-00-01

Set bestehend aus:

Set consisting of:

Juego formado por:

Set composé de:

Set composto da:

18-545-01-01

18-545-02-01

18-545-10-01

18-545-11-01

18-545-12-01

18-545-13-01

18-545-15-01

18-545-01-01

15 cm / 5 7/8"

Handgriff

Handle

Mango

Manche

Manico

18-545-02-01

2,5 cm / 1"

Schlaucholive

Olive

Olive

Olive

Olive

Ø 9,9 mm

18-545-15-01

Saugspitze

suction tip

punta de succión

pointe de succion

punta per aspirazione

## Sauger

Suction Tubes  
Tubos de aspiración  
Tubes d'aspiration  
Tubi d'aspirazione

## Sauger, Kanülen

Suction Tubes, Cannulas  
Tubos de Aspiración, Cánulas  
Tubes d'aspiration, Canules  
Tubi d'aspirazione, Cannule

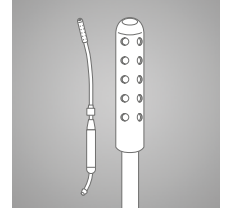

	Saugrohr Suction tube Tubo de aspiración Tube d'aspiration Tubo di aspirazione	Spülrohr Irrigation tube Tubo de irrigación Tube d'irrigation Tubo d'irrigazione
18-553-09-07	<b>Ø 0,9 mm</b>	<b>Ø 0,7 mm</b>
18-554-09-07	<b>Ø 1,2 mm</b>	<b>Ø 0,9 mm</b>
18-555-09-07	<b>Ø 1,5 mm</b>	<b>Ø 1,2 mm</b>

House  
18-553-09-07 -  
18-555-09-07

17 cm / 6 5/8"

Saugrohr  
Suction tube  
Tubo de aspiración  
Tube d'aspiration  
Tubo di aspirazione



House  
18-556-06-07

4,5 cm / 1 5/8"

Saugadapter  
Suction adapter  
Adaptador de aspiración  
Adaptateur d'aspiration  
Adattatore di aspirazione



## Sauger, Saugrohre

Suction cannulas, Suction Tubes

Cánulas de aspiración, Tubos de aspiración

Canules d'aspiration, Tubes d'aspiration

Cannule di aspirazione, Tubi di aspirazione



1/2

**Ø 6 mm**  
Nuboer  
18-569-21-01  
21 cm / 8 2/8"  
runde Öffnung  
round opening  
abertura redonda  
ouverture ronde  
apertura rotonda



1/2

**Ø 6 mm**  
Nuboer  
18-571-21-01  
21 cm / 8 2/8"  
ovale Öffnung  
oval opening  
abertura ovalada  
ouverture ovale  
apertura ovale



1/2

Jamieson  
18-572-05-07 -  
18-572-15-07  
27 cm / 10 6/8"

18-572-05-07	<b>Ø 0,5 mm</b>
18-572-10-07	<b>Ø 1,0 mm</b>
18-572-15-07	<b>Ø 1,5 mm</b>



1/2

Jamieson  
18-573-05-07 -  
18-573-10-07  
27 cm / 10 6/8"

18-573-05-07	<b>Ø 0,5 mm</b>
18-573-10-07	<b>Ø 1,0 mm</b>

## Sauger, Saugrohre

Suction cannulas, Suction Tubes

Cánulas de aspiración, Tubos de aspiración

Canules d'aspiration, Tubes d'aspiration

Cannule di aspirazione, Tubi di aspirazione

## Sauger, Kanülen

Suction Tubes, Cannulas

Tubos de Aspiración, Cánulas

Tubes d'aspiration, Canules

Tubi d'aspirazione, Cannule

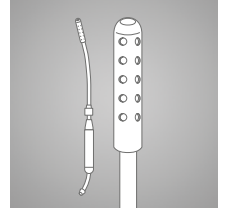

1/1 ○

○

**Ø 1,5 mm**

18-575-05-01

9 cm / 3 4/8"

**Ø 2,0 mm**

18-575-06-01

9 cm / 3 4/8"

1/1 ○

○

**Ø 2,5 mm**

18-575-07-01

9 cm / 3 4/8"

**Ø 3,5 mm**

18-575-08-01

9 cm / 3 4/8"

18-575-05-01-

18-575-08-01

Spitze seitlich perforiert  
tip laterally perforated  
punta perforada lateralmente  
pointe côté perforée  
punta con perforazione laterale



**18-575-24-01**

**Ø 3,0 mm**

18-577-01-01

**Ø 3,5 mm**

18-577-02-01

1/1 ○

**Ø 4,3 mm**

18-577-03-01

Coupland  
18-575-24-01

17 cm / 6 5/8"

Handgriff mit Schlauchansatz  
Handle with connector  
Mango con conexión para tubos  
Manche avec connection pour tubes  
Manico con raccordo per tubi

Byrd  
18-577-01-01 -  
18-577-03-01

21,5 cm / 8 4/8"

**Ø 3,8 mm**  
Cogswell  
18-579-23-01

24,5 cm / 9 5/8"

mit Unterbrecher  
with finger cut-off  
con placa desconectadona  
avec plaque interrupteur  
con placa interuttore

## Spezialkanülen

Special Needles

Agujas especiales

Aiguilles spéciales

Aghi speciali



1/2

	Arbeitslänge working length largo útil longueur utile lunghezza utile	1/1
18-632-12-07	<b>76 mm</b>	<b>Ø 1,2 mm</b>
18-632-14-07	<b>76 mm</b>	<b>Ø 1,4 mm</b>
18-632-16-07	<b>76 mm</b>	<b>Ø 1,6 mm</b>

mit Spezialspitze, Luer-Lock Ansatz  
with special tip, Luer-Lock connection  
con punta especial, conexión Luer-Lock  
avec pointe spéciale, raccord Luer-Lock  
con punta speciale, raccordo Luer-Lock

Tuohy

18-632-12-07 -

18-632-16-07

Lumbalpunktionskanüle  
Lumbar Puncture Needle  
Aguja para punción lumbar  
Aiguille pour ponction lombaire  
Cannula per puntura lumbale



1/2

**Ø 1,5 mm**

Verhoeven

18-635-10-07

10 cm / 3 7/8"

Saugkanüle  
Suction cannula  
Cánula de aspiración  
Canule d'aspiration  
Cannula di aspirazione



1/2

1/1

abgesetzte Spitze  
tapered tip  
punta reducida  
pointe de reduction  
punta ridotta  
**Ø 0,65 mm**

18-640-10-07

Luer-Lock Ansatz  
Luer Lock connection  
conexión Luer-Lock  
raccord Luer-Lock  
raccordo Luer-Lock

1/1



1/2

abgesetzte Spitze  
tapered tip  
punta reducida  
pointe de reduction  
punta ridotta  
**Ø 0,80 mm**



1/1

abgesetzte Spitze  
tapered tip  
punta reducida  
pointe de reduction  
punta ridotta  
**Ø 0,65 mm**

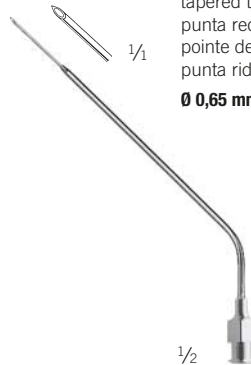

1/2



1/2

18-641-20-07 **Ø 1,0 mm**

18-642-20-07 **Ø 1,3 mm**

18-640-15-07

Luer-Lock Ansatz  
Luer Lock connection  
conexión Luer-Lock  
raccord Luer-Lock  
raccordo Luer-Lock

18-640-20-07

Tonsillenkanüle, Luer-Lock-Ansatz  
Tonsil cannula, Luer Lock connection  
Cánula para amígdalas, conexión Luer-Lock  
Aiguille pour amygdales, raccord Luer-Lock  
Cannula per tonsille, raccordo Luer-Lock

18-641-20-07 -

18-642-20-07

Tonsillenkanüle, gewinkelt  
Tonsil cannula, angled  
Cánula para amígdalas, acodada  
Aiguille pour amygdales, angulée  
Cannula per tonsille, angolata

## Saugkanülen

Suction Cannulas  
Cánulas de aspiración  
Canules d'aspiration  
Cannule di aspirazione

## Sauger, Kanülen

Suction Tubes, Cannulas  
Tubos de Aspiración, Cánulas  
Tubes d'aspiration, Canules  
Tubi d'aspirazione, Cannule

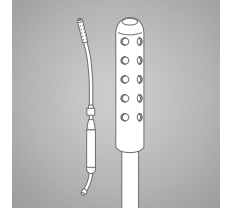

### Plester

18-645-15-07 -  
18-645-30-07

19,5 cm / 7 5/8"

Saugkanüle  
Suction cannula  
Cánula de aspiración  
Canule d'aspiration  
Cannula di aspirazione

18-647-15-07 -  
18-647-20-07

16 cm / 6 2/8"

Saugkanüle, biegsam  
Suction cannula, malleable  
Cánula de aspiración, maleable  
Canule d'aspiration, malléable  
Cannula di aspirazione, malleabile

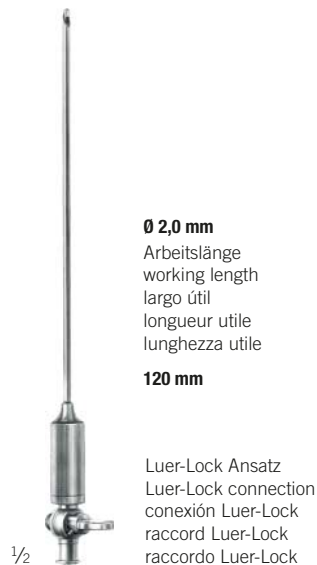
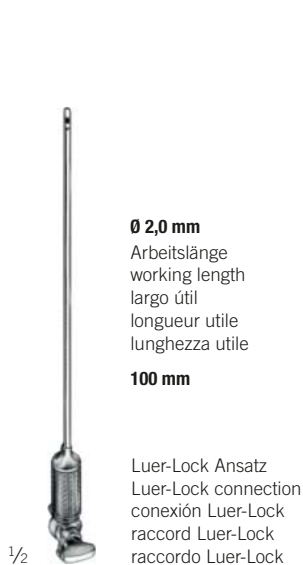

### Verres

18-665-20-07

Insufflationskanüle  
Insufflation Cannula  
Cánula para insuflación  
Canule pour insufflation  
Cannula per insufflazione

### Verres

18-666-20-07

Insufflationskanüle  
Insufflation Cannula  
Cánula para insuflación  
Canule pour insufflation  
Cannula per insufflazione

### Vollmar

18-691-15-07 -  
18-691-40-07

6 cm / 2 3/8"

Luer-Lock Ansatz  
Luer-Lock connection  
conexión Luer-Lock  
raccord Luer-Lock  
raccordo Luer-Lock



Naht  
Suture  
Sutura  
Suture  
Sutura

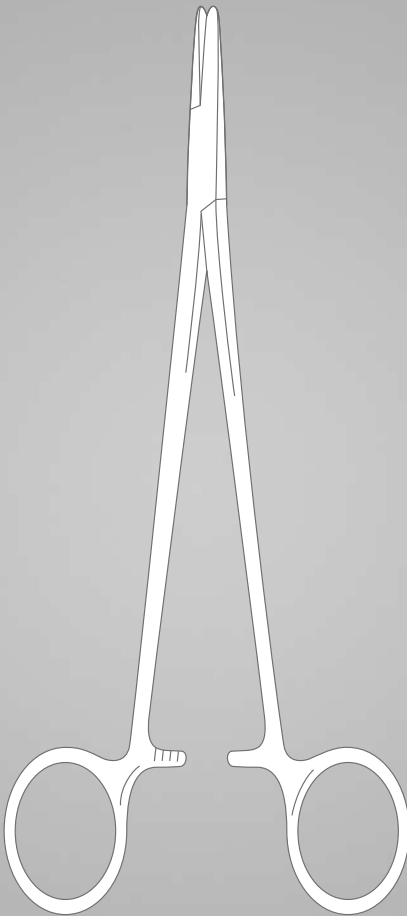

# Nadelhalter

Needle Holders

Porta-agujas

Porte-aiguilles

Portaghi

## TC GOLD



Webster  
20-630-13-07  
13 cm / 5 1/8"



Kilner  
20-631-13-07  
14,5 cm / 5 9/16"

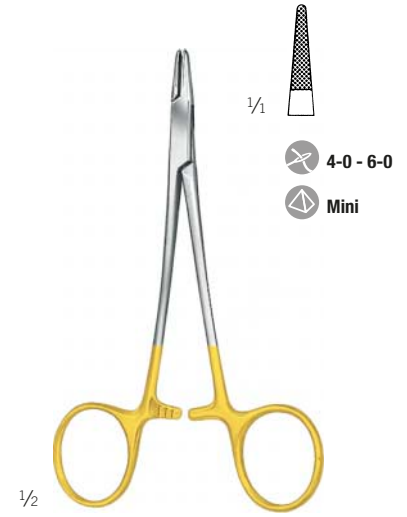

Derf  
20-632-12-07  
12 cm / 4 9/16"



Hegar-Baumgartner  
20-634-13-07 -  
20-634-14-07



Halsey  
20-636-13-07 -  
20-637-13-07  
13 cm / 5 1/8"

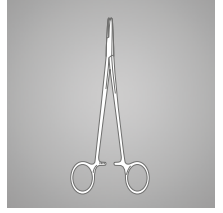

**TC GOLD**

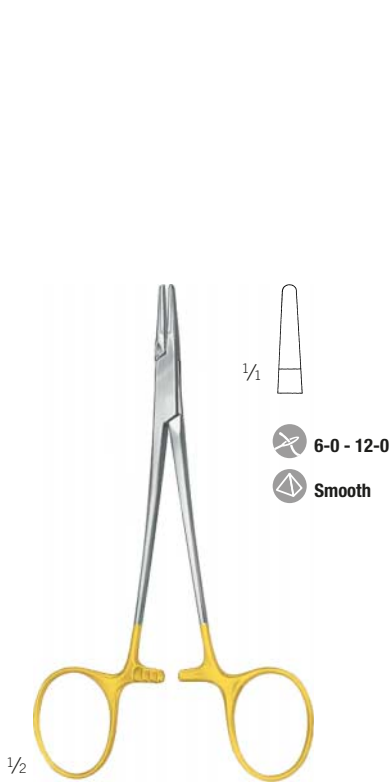

Webster  
 20-637-12-07  
 12 cm / 4 5/8"

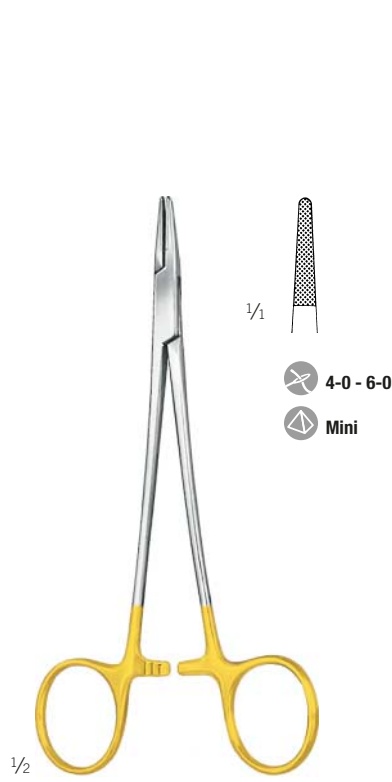

Crile-Wood  
 20-638-15-07  
 15 cm / 5 7/8"



Crile-Wood  
 20-638-20-07  
 20,5 cm / 8 1/8"



# Nadelhalter

Needle Holders

Porta-agujas

Porte-aiguilles

Portaghi

## TC GOLD



1/2

Sarot  
20-640-18-07 -  
20-640-26-07



20-640-18-07  
18 cm / 7 1/8"



20-640-20-07  
20 cm / 7 7/8"



20-640-26-07  
26 cm / 10 2/8"



1/2

Mayo-Hegar  
20-642-16-07 - 20-642-30-07



20-642-16-07  
16 cm / 6 2/8"



20-642-18-07  
18,5 cm / 7 2/8"



20-642-20-07  
20 cm / 7 7/8"



20-642-24-07  
24 cm / 9 4/8"



20-642-26-07  
26,5 cm / 10 3/8"



20-642-30-07  
30 cm / 11 6/8"



# Nadelhalter

Needle Holders  
Porta-agujas  
Porte-aiguilles  
Portaghi

# Naht

Suture  
Sutura  
Suture  
Sutura



## TC GOLD



1/2

Heaney  
20-643-20-07 -  
20-643-26-07



1/1

20-643-20-07  
20,5 cm / 8 1/8"



20-643-24-07  
24 cm / 9 4/8"



20-643-26-07  
26,5 cm / 10 3/8"



1/2

DeBakey  
20-646-18-07 - 20-646-31-07

schlankes Model  
slender pattern  
modelo delgado  
modèle gracile  
modello delicato

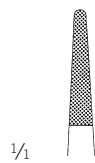

1/1

20-646-18-07  
18 cm / 7 1/8"



20-646-20-07  
20,5 cm / 8 1/8"



20-646-23-07  
23 cm / 9 "



1/1

20-646-26-07  
26,5 cm / 10 3/8"



20-646-31-07  
31 cm / 12 2/8"



# Nadelhalter

Needle Holders

Porta-agujas

Porte-aiguilles

Portaghi

## TC GOLD

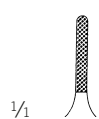

20-650-13-07  
12,5 cm / 4 7/8"



20-650-15-07  
15 cm / 5 7/8"



20-650-18-07  
18 cm / 7 1/8"

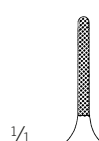

20-650-20-07  
20 cm / 7 7/8"



20-650-23-07  
23 cm / 9"



20-650-26-07  
26 cm / 10 2/8"



Ryder (Martin)  
20-650-13-07 -  
20-650-26-07

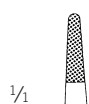

20-652-15-07  
15 cm / 5 7/8"



20-652-17-07  
17 cm / 6 5/8"



20-652-20-07  
20,5 cm / 8 1/8"



Martin  
20-652-15-07 -  
20-652-20-07

elastisches Modell  
elastic tip  
modelo elástico  
modèle souple  
modello molle



**TC GOLD**



1/2

Martini  
20-668-00-07 -  
20-668-03-07

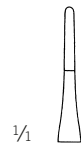

20-668-00-07

14 cm / 5 4/8"



20-668-01-07

15 cm / 5 7/8"



20-668-02-07

17,5 cm / 6 7/8"



20-668-03-07

20 cm / 7 7/8"

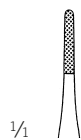

20-670-00-07

14 cm / 5 4/8"

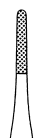

20-670-01-07

15 cm / 5 7/8"



20-670-02-07

17,5 cm / 6 7/8"

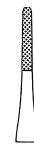

20-670-03-07

20 cm / 7 7/8"



1/2

Martini  
20-670-00-07 -  
20-670-03-07

schlankes Modell  
delicate pattern  
modelo delgado  
modèle gracile  
modelo gracile



Knochenchirurgie  
Bone Surgery  
Cirugía ósea  
Chirurgie osseuse  
Chirurgia ossea

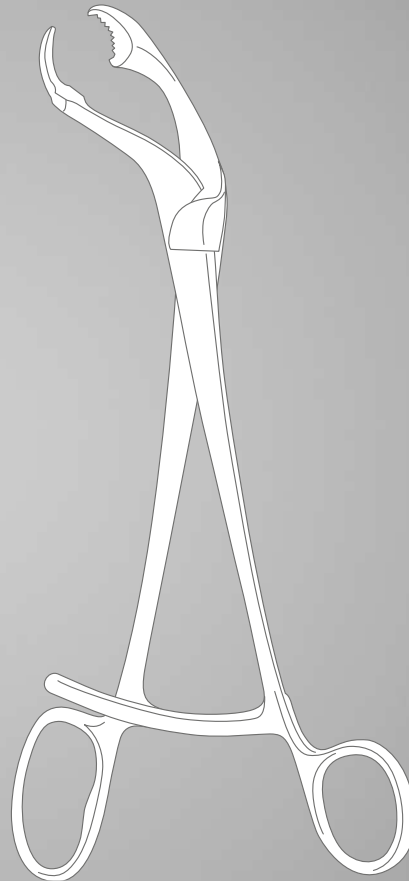
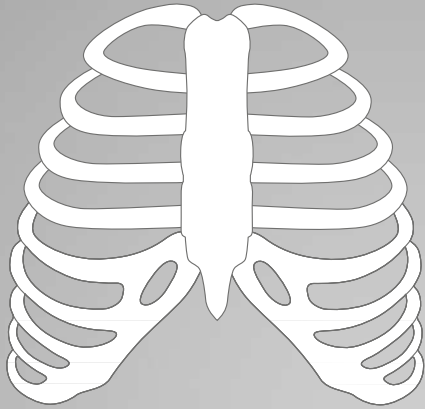

# Handbohrapparate

Hand Drills

Perforadores de mano

Perforateurs à main

Perforatori a mano



1/3

**Fig. 1**  
22-152-01-07



Kegelfräser  
Conical burr  
Fresa cónica  
Fraise conique  
Fresa cuneiforme



**Fig. 2**  
22-152-02-07



Kegelfräser  
Conical burr  
Fresa cónica  
Fraise conique  
Fresa cuneiforme



**Fig. 3**  
22-152-03-07



Kugelfräser  
Spherical burr  
Fresa esférica  
Fraise sphérique  
Fresa sferica



**Fig. 4**  
22-152-04-07

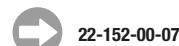

Kugelfräser  
Spherical burr  
Fresa esférica  
Fraise sphérique  
Fresa sferica



1/3

**Hudson**  
22-152-00-07

28 cm / 11 "

komplett, mit Fräsern Fig. 1 - 4  
und Verlängerungsstück

complete, with burrs no. 1 - 4  
and extension piece

completo, con fresas no. 1 - 4  
y pieza de extensión

complet, avec fraises no. 1 - 4  
et pièce de rallonge

completo, con frese no. 1 - 4  
e giunto di prolungamento



1/3

**Fig. 5**  
22-152-05-07



Flachfräser  
Flat burr  
Taladro cónica  
Fraise conique  
Trapano cuneiforme



**Fig. 6**  
22-152-06-07



Spiralbohrer  
Twist drill  
Broca espiral  
Mèche hélicoïdale  
Punta a spirale



**Fig. 7**  
22-152-07-07



Bohrer  
Burr  
Fresa  
Fraise  
Punta



**Fig. 8**  
22-152-08-07



Bohrer  
Burr  
Fresa  
Fraise  
Punta



**Fig. 9**  
22-152-09-07



Verlängerungsstück  
Extension piece  
Pieza de prolongación  
Pièce de rallonge  
Giunto di prolungamento

# Hohlmeißel, Flachmeißel, Osteotome

Gouges, Chisels, Osteotomes  
 Gubias, Cinceles, Osteótomos  
 Gouges, Ciseaux-burins, Ostéotomes  
 Sgorbie, Scalpelli, Osteotomi

# Knochenchirurgie

Bone Surgery  
 Cirugía ósea  
 Chirurgie osseuse  
 Chirurgia ossea

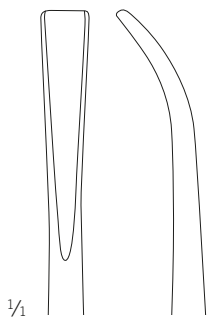
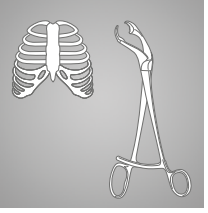

5,5 mm  
23-112-05-04

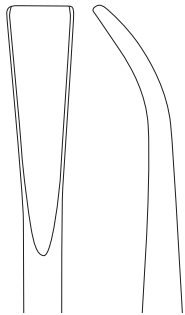

9 mm  
23-112-09-04



1/2

Zielke  
 23-112-05-04 -  
 23-112-09-04  
 23 cm / 9"

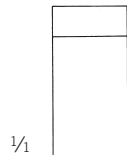

1/1  
 10 mm  
 23-123-10-07

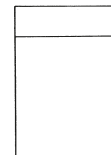

12 mm  
 23-123-12-07

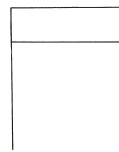

15 mm  
 23-123-15-07



20 mm  
 23-123-20-07

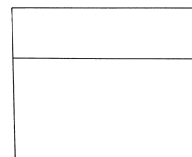

25 mm  
 23-123-25-07



1/2

Stille  
 23-123-10-07 -  
 23-123-25-07  
 20,5 cm / 8 1/8"

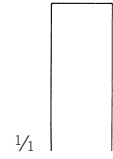

1/1  
 8 mm  
 23-124-08-07



10 mm  
 23-124-10-07

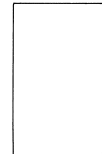

12 mm  
 23-124-12-07

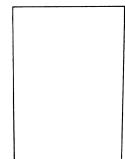

15 mm  
 23-124-15-07

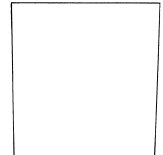

20 mm  
 23-124-20-07

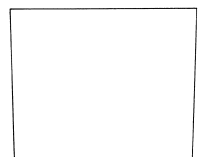

25 mm  
 23-124-25-07



1/2

Stille  
 23-124-08-07 -  
 23-124-25-07  
 20,5 cm / 8 1/8"



## Flachmeißel, Hohlmeißel

Chisels, Gouges

Cinceles, Gubias

Ciseaux-burins, Gouges

ScalPELLI, Sgorbie

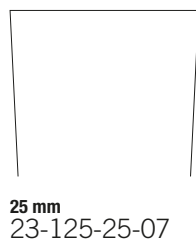
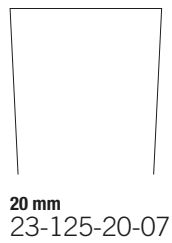
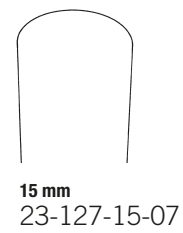
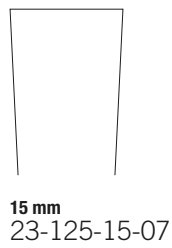
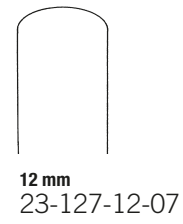
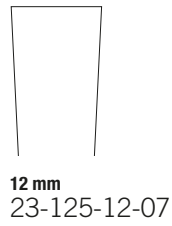
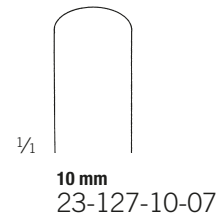
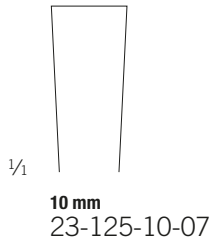

Stille  
 23-125-10-07 -  
 23-125-25-07

20,5 cm / 8 1/8"

fein  
 delicate  
 fino  
 fin  
 fino

Stille  
 23-127-10-07 -  
 23-127-25-07

20,5 cm / 8 1/8"

## Meißelklingen, Meißelgriff

Chisel Blades, Chisel Handle

Hojas de cincel, Mango para hojas de cincel

Lames-gouges, Manche pour ciseaux-burins

Lame per sgorbie, Manico per scalpello

## Knochenchirurgie

Bone Surgery

Cirugía ósea

Chirurgie osseuse

Chirurgia ossea

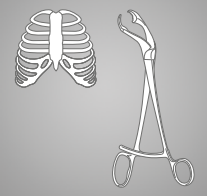

1/4

Hohlmeißelklingen, auswechselbar  
Gouge blades, interchangeable  
Hojas de gubia, intercambiables  
Lames-gouges, interchangeables  
Lame intercambiabili, concavo

r = 50 mm

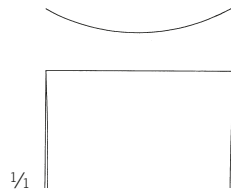

1/4

25 mm  
23-128-50-07  
13,5 cm / 5 3/8"

➔ 23-130-00-04

r = 60 mm

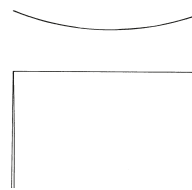

25 mm  
23-128-60-07  
13,5 cm / 5 3/8"

➔ 23-130-00-04

r = 70 mm

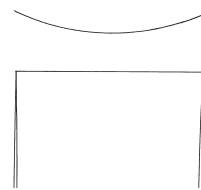

25 mm  
23-128-70-07  
13,5 cm / 5 3/8"

➔ 23-130-00-04

23-128-50-07 -  
23-128-70-07

Meißelklingen, auswechselbar  
Chisel blades, interchangeable  
Hojas de cincel, intercambiables  
Lames ciseaux-burin, interchangeables  
Lame intercambiabili



1/2

23-130-90-98  
Halteschraube  
Spare Screw  
Tornillo de repuesto  
Vis de rechange  
Vite di ricambio

➔ 23-130-00-04

23-130-99-07  
Spannschlüssel  
Key  
Llave  
Clé  
Chiave

➔ 23-130-00-04

23-130-00-04  
18,5 cm / 7 2/8"

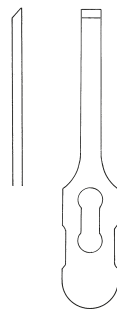

5 mm  
23-130-05-07  
8 cm / 3 1/8"

➔ 23-130-00-04



10 mm  
23-130-10-07  
8 cm / 3 1/8"

➔ 23-130-00-04



16 mm  
23-130-16-07  
8 cm / 3 1/8"

➔ 23-130-00-04

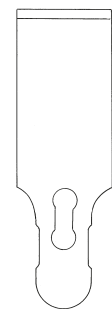

25 mm  
23-130-25-07  
8 cm / 3 1/8"

➔ 23-130-00-04

Osteotomklingen, auswechselbar  
Osteotome blades, interchangeable  
Hojas de osteótomo, intercambiables  
Lame per osteotomia, intercambiabili  
Lame per osteotomia, intercambiabili

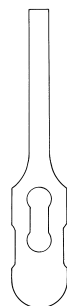

5 mm  
23-130-55-07  
8 cm / 3 1/8"

➔ 23-130-00-04



10 mm  
23-130-60-07  
8 cm / 3 1/8"

➔ 23-130-00-04

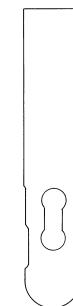

16 mm  
23-130-66-07  
8 cm / 3 1/8"

➔ 23-130-00-04

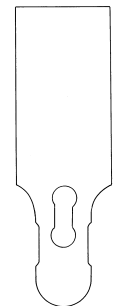

25 mm  
23-130-85-07  
8 cm / 3 1/8"

➔ 23-130-00-04

## Osteotome, Hohlmeißel

Osteotomes, Gouges

Osteótomos, Gubias

Ostéotomes, Gouges

Osteotomi, Sgorbie

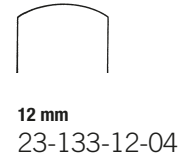
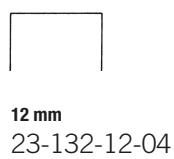
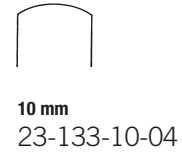
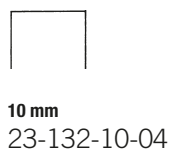
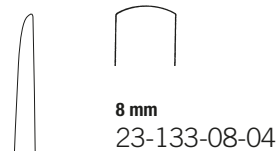
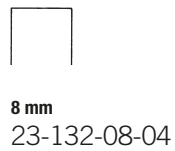
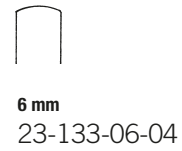

Lexer-Mini  
23-132-04-04 -  
23-132-12-04  
18 cm / 7  $\frac{1}{8}$ "

Lexer-Mini  
23-133-04-04 -  
23-133-12-04  
18 cm / 7  $\frac{1}{8}$ "



## Osteotome, Hohlmeißel

Osteotomes, Gouges  
Osteótomos, Gubias  
Ostéotomes, Gouges  
Osteotomi, Sgorbie

## Knochenchirurgie

Bone Surgery  
Cirugía ósea  
Chirurgie osseuse  
Chirurgia ossea

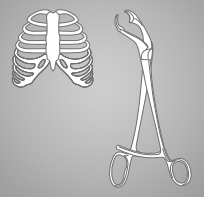

5 mm

23-134-05-04



7 mm

23-134-07-04



10 mm

23-134-10-04

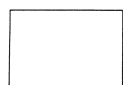

15 mm

23-134-15-04

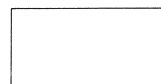

20 mm

23-134-20-04

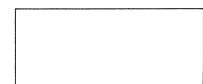

25 mm

23-134-25-04

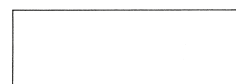

30 mm

23-134-30-04

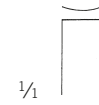

5 mm

23-135-05-04



7 mm

23-135-07-04



10 mm

23-135-10-04

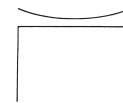

15 mm

23-135-15-04

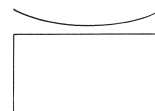

20 mm

23-135-20-04

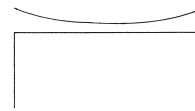

25 mm

23-135-25-04



30 mm

23-135-30-04



1/2

Lexer  
23-134-05-04 -  
23-134-30-04  
22 cm / 8 5/8"



1/2

Lexer  
23-135-05-04 -  
23-135-30-04  
22 cm / 8 5/8"



# Osteotome

Osteotomes

Osteótomos

Ostéotomes

Osteotomi



**2 mm**  
23-136-02-07



**3 mm**  
23-136-03-07



**4 mm**  
23-136-04-07



**6 mm**  
23-136-06-07



**8 mm**  
23-136-08-07



**10 mm**  
23-136-10-07



**12 mm**  
23-136-12-07



**15 mm**  
23-136-15-07



**3 mm**  
23-136-53-07



**4 mm**  
23-136-54-07



**6 mm**  
23-136-56-07



**8 mm**  
23-136-58-07



**10 mm**  
23-136-60-07

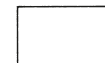

**12 mm**  
23-136-62-07

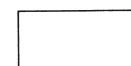

**15 mm**  
23-136-65-07



Lambotte-Mini  
23-136-02-07 -  
23-136-15-07  
12,5 cm / 4 7/8"



Lambotte-Mini  
23-136-53-07 -  
23-136-65-07  
17 cm / 6 5/8"

# Osteotome

Osteotomes  
Osteótomos  
Ostéotomes  
Osteotomi

# Knochenchirurgie

Bone Surgery  
Cirugía ósea  
Chirurgie osseuse  
Chirurgia ossea

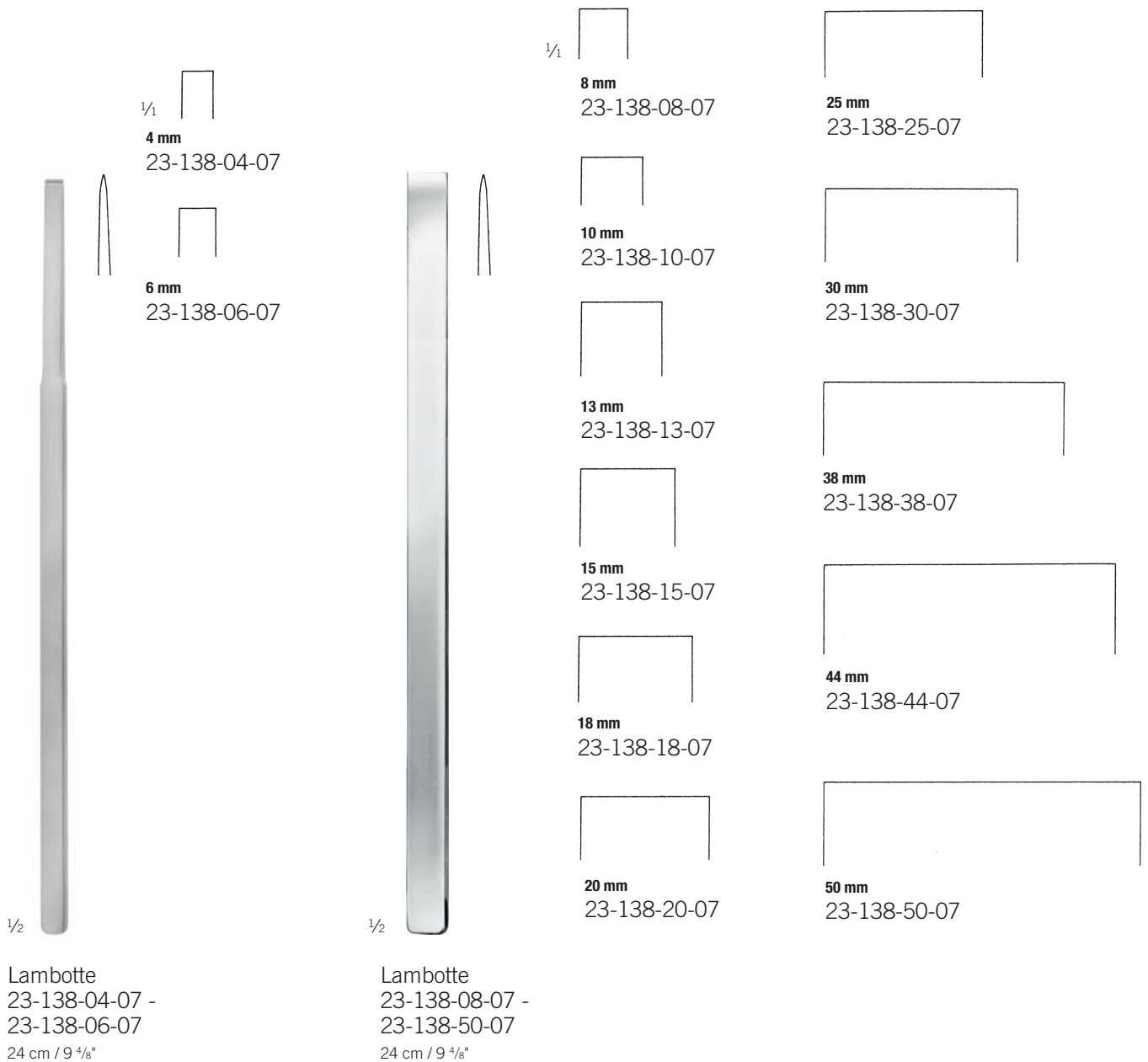
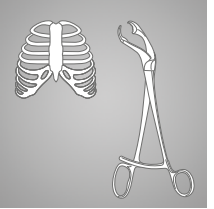

# Osteotome

Osteotomes

Osteótomos

Ostéotomes

Osteotomi

1/4



**4 mm**

23-139-04-07

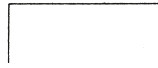

**20 mm**

23-139-20-07



**6 mm**

23-139-06-07

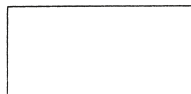

**25 mm**

23-139-25-07



**8 mm**

23-139-08-07

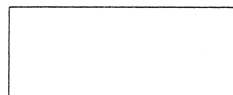

**30 mm**

23-139-30-07



**10 mm**

23-139-10-07

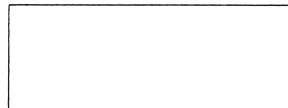

**38 mm**

23-139-38-07

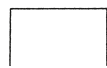

**13 mm**

23-139-13-07

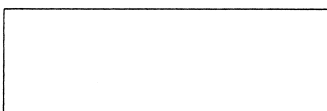

**44 mm**

23-139-44-07

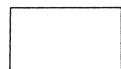

**15 mm**

23-139-15-07

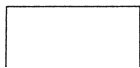

**18 mm**

23-139-18-07

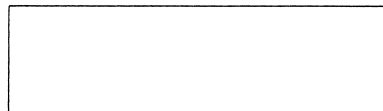

**50 mm**

23-139-50-07

1/2



Lambotte  
23-139-04-07 -  
23-139-50-07  
24 cm / 9 4/8"

# Osteotome

Osteotomes  
Osteótomos  
Ostéotomes  
Osteotomi

# Knochenchirurgie

Bone Surgery  
Cirugía ósea  
Chirurgie osseuse  
Chirurgia ossea

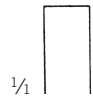
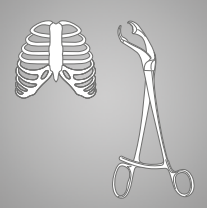

**6 mm**  
23-154-06-07



**9 mm**  
23-154-09-07

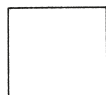

**13 mm**  
23-154-13-07

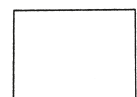

**16 mm**  
23-154-16-07

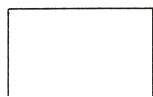

**19 mm**  
23-154-19-07

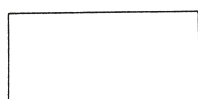

**25 mm**  
23-154-25-07

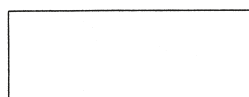

**32 mm**  
23-154-32-07

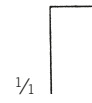

**6 mm**  
23-155-06-07



**9 mm**  
23-155-09-07

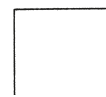

**13 mm**  
23-155-13-07

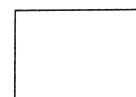

**16 mm**  
23-155-16-07

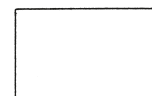

**19 mm**  
23-155-19-07

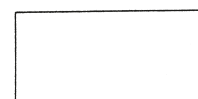

**25 mm**  
23-155-25-07

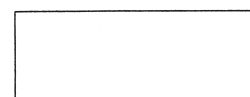

**32 mm**  
23-155-32-07



1/2

Smith-Petersen  
23-154-06-07 -  
23-154-32-07  
20,5 cm / 8 1/8"



1/2

Smith-Petersen  
23-155-06-07 -  
23-155-32-07  
20,5 cm / 8 1/8"



# Hohlmeißel, Osteotome

Gouges, Osteotomes

Gubias, Osteótomos

Gouges, Ostéotomes

Sgorbie, Osteotomi

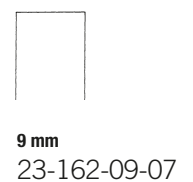
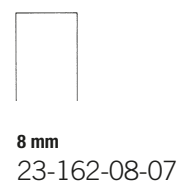
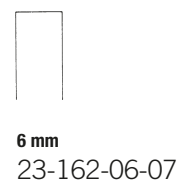
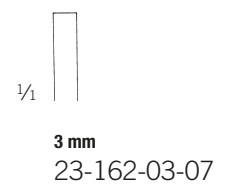
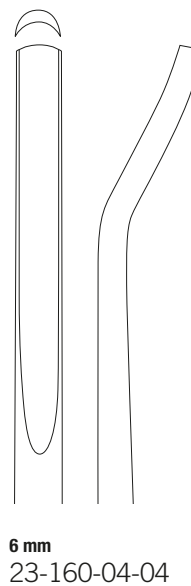
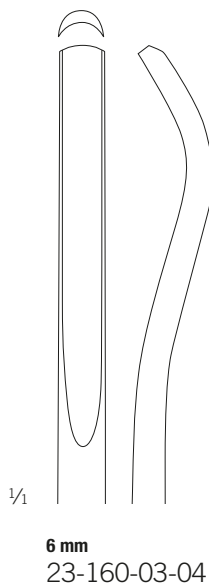
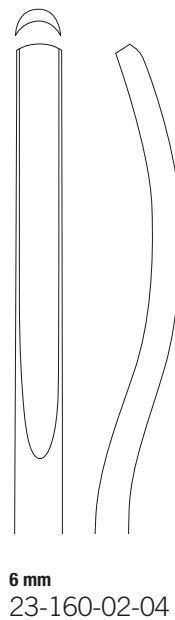
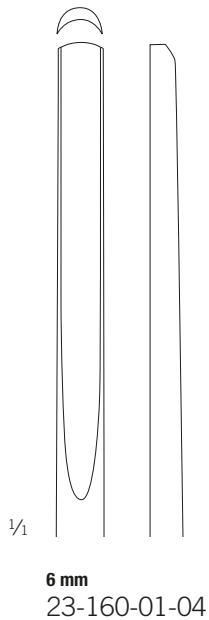

Cobb  
23-160-01-04 -  
23-160-04-04  
28 cm / 11"

Hoke  
23-162-03-07 -  
23-162-09-07  
17 cm / 6 5/8"



## Septummeißel, Septum-Hohlmeißel

Septum Chisels, Septum Gouges

Cinceles para tabique nasal, Gubias para tabique nasal

Élévateurs pour le périoste, Gouges pour la cloison nasale

Elevatori per il periosto, Sgorbie per il setto nasale

## Knochenchirurgie

Bone Surgery

Cirugía ósea

Chirurgie osseuse

Chirurgia ossea

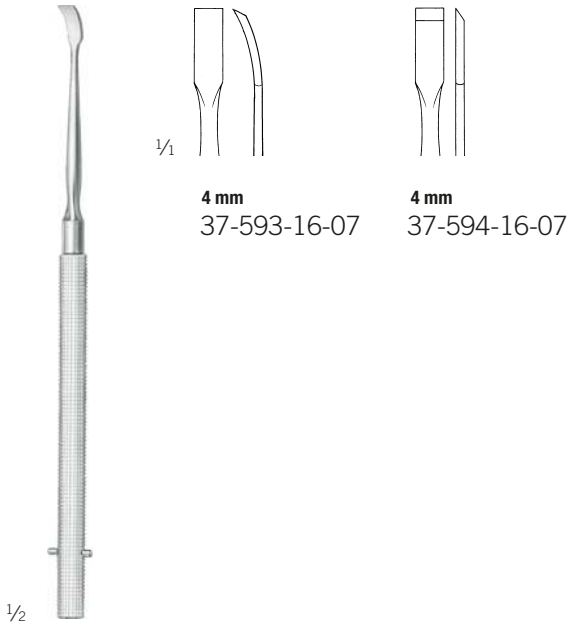
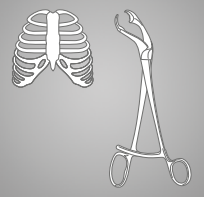

Freer  
37-593-16-07 -  
37-594-16-07  
16,5 cm / 6 5/8"

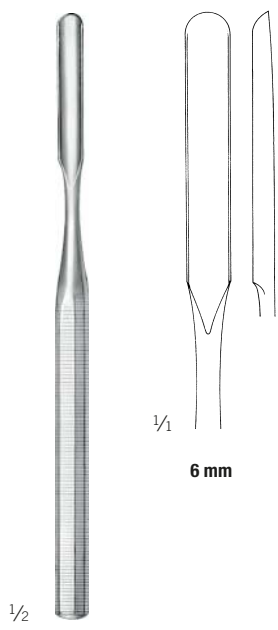

Freer  
37-595-15-07  
16 cm / 6 2/8"

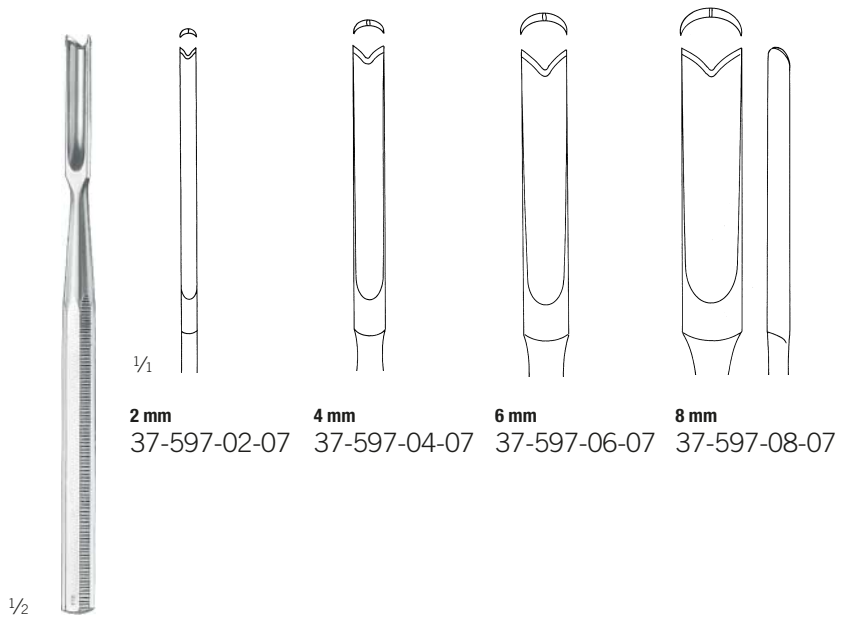

Ballenger  
37-597-02-07 -  
37-597-08-07  
15 cm / 5 7/8"

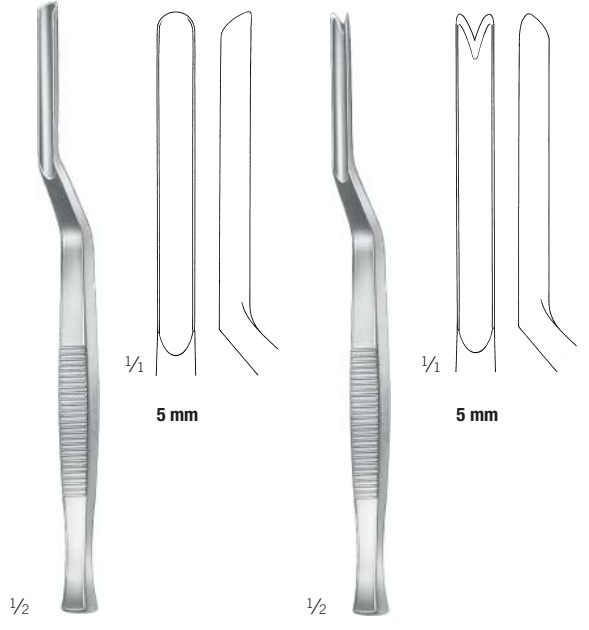

Killian  
37-601-16-07  
16 cm / 6 2/8"

Killian-Claus  
37-605-16-07  
16 cm / 6 2/8"

## Osteotome

Osteotomes

Osteótomos

Ostéotomes

Osteotomi

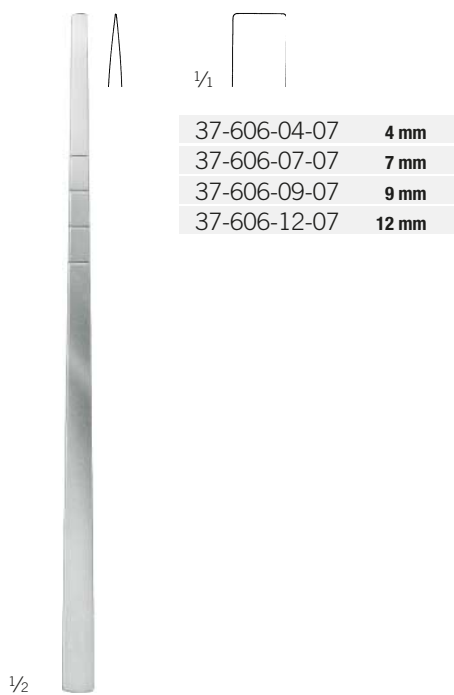

Cottle  
37-606-04-07 -  
37-606-12-07  
18,5 cm / 7 2/8"



Cottle  
37-607-06-07  
18,5 cm / 7 2/8"

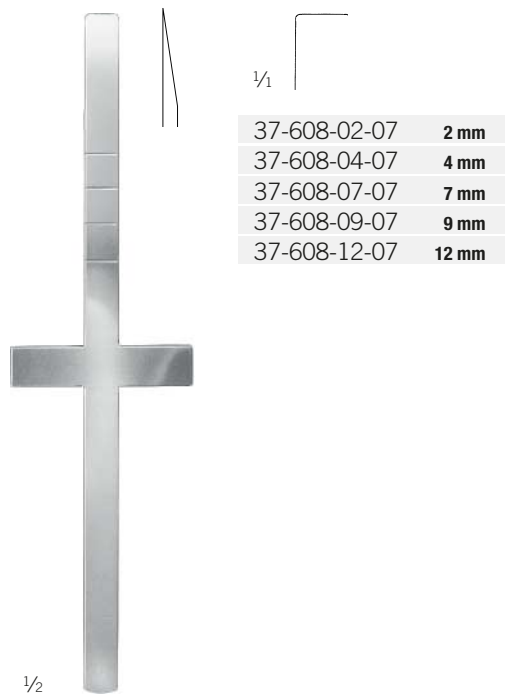

Cottle  
37-608-02-07 -  
37-608-12-07  
18,5 cm / 7 2/8"

## Osteotome

Osteotomes  
Osteótomos  
Ostéotomes  
Osteotomi

## Knochenchirurgie

Bone Surgery  
Cirugía ósea  
Chirurgie osseuse  
Chirurgia ossea

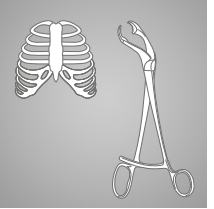

Cottle  
37-609-06-07  
18,5 cm / 7 2/8"

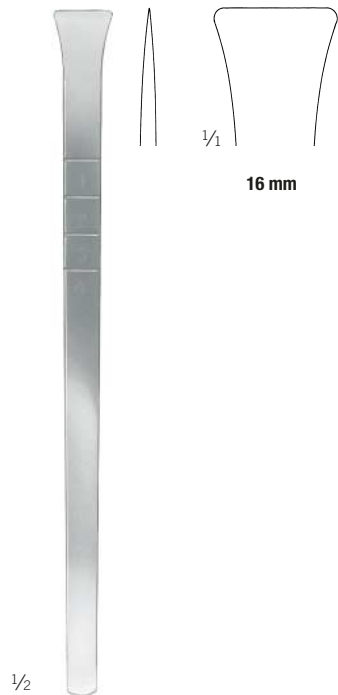

Cottle  
37-610-16-07  
18,5 cm / 7 2/8"

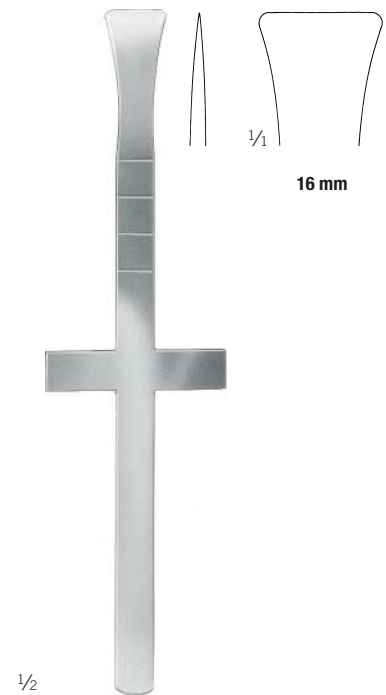

Cottle  
37-612-16-07  
18,5 cm / 7 2/8"

## Osteotome, Meißel

Osteotomes, Chisels  
 Osteótomos, Cinceles  
 Ostéotomes, Ciseaux-burins  
 Osteotomi, Scalpelli

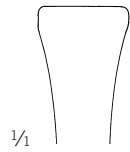

37-616-10-07	<b>10 mm</b>
37-616-12-07	<b>12 mm</b>
37-616-14-07	<b>14 mm</b>

Rubin  
 37-616-10-07 -  
 37-616-14-07  
 18,5 cm / 7 <sup>2</sup>/<sub>8</sub>"



**3 mm**  
 37-620-03-07

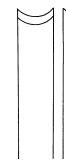

**4,5 mm**  
 37-620-04-07

Walter  
 37-620-03-07 -  
 37-620-04-07  
 19 cm / 7 <sup>4</sup>/<sub>8</sub>"

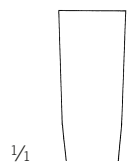

37-622-03-07	<b>3 mm</b>
37-622-04-07	<b>4 mm</b>
37-622-07-07	<b>7 mm</b>
37-622-09-07	<b>9 mm</b>
37-622-12-07	<b>12 mm</b>

Walter  
 37-622-03-07 -  
 37-622-12-07  
 19 cm / 7 <sup>4</sup>/<sub>8</sub>"



37-623-04-07	<b>4 mm</b>
37-623-05-07	<b>5 mm</b>
37-623-06-07	<b>6 mm</b>
37-623-07-07	<b>7 mm</b>

Fomon  
 37-623-04-07 -  
 37-623-07-07  
 16 cm / 6 <sup>2</sup>/<sub>8</sub>"

# Stößel

Tamper  
Punzón  
Pilon  
Pestone

# Knochenchirurgie

Bone Surgery  
Cirugía ósea  
Chirurgie osseuse  
Chirurgia ossea

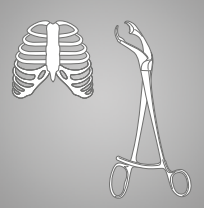

1/1 

23-197-03-04

Ø 3 mm



23-197-05-04

Ø 5 mm



23-197-08-04

Ø 8 mm



1/2

Caspar  
23-197-03-04 -  
23-197-08-04  
22 cm / 8 5/8"

 Sic

1/1

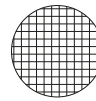

23-199-12-04

Ø 12 mm

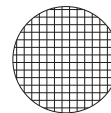

23-199-14-04

Ø 14 mm

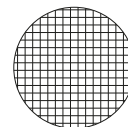

23-199-16-04

Ø 16 mm



1/2

23-199-12-04 -  
23-199-16-04  
20 cm / 8"

 Sic

## Hämmer

Mallets  
Martillos  
Maillets  
Martelli

Ø Kopf	Kopfgewicht
Ø Head	Head weight
Ø Cabeza	Peso de la cabeza
Ø Tête	Poids de tête
Ø Testa	Peso della testa
<b>34 mm</b>	<b>460 g</b>

Ø Kopf	Kopfgewicht
Ø Head	Head weight
Ø Cabeza	Peso de la cabeza
Ø Tête	Poids de tête
Ø Testa	Peso della testa
<b>30 mm</b>	<b>200 g</b>



Cottle  
23-215-19-07

19 cm / 7 7/8"

plan/konvex  
plane / convex  
plano / convexo  
plan / convexe  
plano / convesso

Gesamtgewicht  
Total weight  
Peso total  
Poids total  
Peso totale

**300 g**



23-256-00-04

Ersatzbacke  
Spare facing  
Tapa de repuesto  
Placque de rechange  
Placche di ricambio



23-240-29-04,  
23-254-22-04



23-240-29-04

25 cm / 9 7/8"

plan (Kunststoff), konvex (Stahl),  
plane (nylon), convex (steel),  
plano (nilón), convexo (acero),  
plan (nylon), convexe (acier),  
plano (nilon), convesso (acciaio),



Gesamtgewicht  
Total weight  
Peso total  
Poids total  
Peso totale

**700 g**

## Hämmer

Mallets  
Martillos  
Maillets  
Martelli

## Knochenchirurgie

Bone Surgery  
Cirugía ósea  
Chirurgie osseuse  
Chirurgia ossea

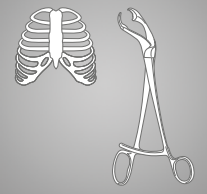

Ø Kopf  
Ø Head  
Ø Cabeza  
Ø Tête  
Ø Testa

Kopfgewicht  
Head weight  
Peso de la cabeza  
Poids de tête  
Peso della testa

**34 mm**     **270 g**



1/2



23-256-00-04

Ersatzbacke  
Spare facing  
Tapa de repuesto  
Plaque de rechange  
Placche di ricambio



23-240-29-04,  
23-254-22-04

Ø Kopf  
Ø Head  
Ø Cabeza  
Ø Tête  
Ø Testa

Kopfgewicht  
Head weight  
Peso de la cabeza  
Poids de tête  
Peso della testa

**25 mm**     **130 g**



1/2



23-262-90-98

Ersatzbacken (Paar)  
Spare facings (pair)  
Tapas de repuesto (par)  
Plaques de rechange (paire)  
Placche di ricambio (paio)



23-262-19-04

23-254-22-04

25 cm / 9 7/8"



Gesamtgewicht  
Total weight  
Peso total  
Poids total  
Peso totale

**510 g**

23-262-19-04

19 cm / 7 1/8"



Gesamtgewicht  
Total weight  
Peso total  
Poids total  
Peso totale

**260 g**



## Scharfe Löffel

Bone Currettes

Cucharillas cortantes

Curettes tranchantes

Curette taglienti

1/1 ○

2,5 mm  
Fig. 0000

23-280-40-04

○

3,0 mm  
Fig. 000

23-280-30-04

1/1 ○

4,5 mm  
Fig. 0

23-282-10-04

○

5,5 mm  
Fig. 1

23-282-01-04

○

3,5 mm  
Fig. 00

23-280-20-04

○

4,5 mm  
Fig. 0

23-280-10-04

○

6,0 mm  
Fig. 2

23-282-02-04

○

7 mm  
Fig. 3

23-282-03-04

○

5,5 mm  
Fig. 1

23-280-01-04

○

6,0 mm  
Fig. 2

23-280-02-04

○

8,5 mm  
Fig. 4

23-282-04-04

○

7,0 mm  
Fig. 3

23-280-03-04

○

8,5 mm  
Fig. 4

23-280-04-04

○

9,5 mm  
Fig. 5

23-280-05-04

○

11,5 mm  
Fig. 6

23-280-06-04



1/2

Volkman  
23-282-01-04 -  
23-282-10-04

27 cm / 10 5/8"

oval  
oval  
ovalada  
ovale  
ovala



1/2

Volkman  
23-280-01-04 -  
23-280-40-04

17 cm / 6 5/8"

oval  
oval  
ovalada  
ovale  
ovala

## Scharfe Löffel

Bone Curettes  
Cucharillas cortantes  
Curettes tranchantes  
Curette taglienti

## Knochenchirurgie

Bone Surgery  
Cirugía ósea  
Chirurgie osseuse  
Chirurgia ossea

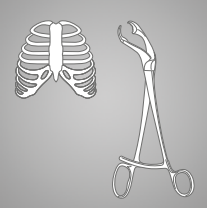

1/4 ○

**3,0 mm**  
**Fig. 0000**  
23-304-40-07

○

**3,7 mm**  
**Fig. 000**  
23-304-30-07

1/4 ○

**2,8 mm**  
**Fig. 0000**  
23-306-40-07

○

**4,5 mm**  
**Fig. 00**  
23-304-20-07

○

**5,2 mm**  
**Fig. 0**  
23-304-10-07

○

**3,6 mm**  
**Fig. 000**  
23-306-30-07

○

**6,8 mm**  
**Fig. 1**  
23-305-01-07

○

**8,5 mm**  
**Fig. 2**  
23-305-02-07

○

**4,4 mm**  
**Fig. 00**  
23-306-20-07

○

**10,0 mm**  
**Fig. 3**  
23-305-03-07

○

**11,5 mm**  
**Fig. 4**  
23-305-04-07

○

**5,2 mm**  
**Fig. 0**  
23-306-10-07

○

**13,0 mm**  
**Fig. 5**  
23-305-05-07

○

**14,5 mm**  
**Fig. 6**  
23-305-06-07



1/2

**Volkman**  
23-304-10-07 - 23-305-06-07  
17 cm / 6 5/8"  
oval, mit Hohlheft  
oval, with hollow handle  
ovalada, con mango hueco  
ovale, avec manche creux  
ovale, con manico vuoto



1/2

**Daubenspeck**  
23-306-10-07 - 23-306-40-07  
17 cm / 6 5/8"  
oval, mit Hohlheft  
oval, with hollow handle  
ovalada, con mango hueco  
ovale, avec manche creux  
ovale, con manico vuoto

## Scharfe Löffel

Bone Currettes

Cucharillas cortantes

Curettes tranchantes

Curette taglienti



1/1

4,8 mm  
23-336-25-07



1/1

3,5 mm  
Fig. 3  
23-340-03-07



4,0 mm  
Fig. 4  
23-340-04-07



4,8 mm  
23-337-25-07



4,5 mm  
Fig. 5  
23-340-05-07



4,8 mm  
23-339-25-07



5,5 mm  
Fig. 6  
23-340-06-07

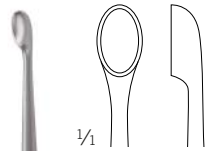

1/1

5,5 mm

1/2



Williger  
23-321-02-07

17,5 cm / 6 7/8"  
oval, mit Hohlheft  
oval, with hollow handle  
ovalada, con mango hueco  
ovale, avec manche creux  
ovala, con manico vuoto

1/2



Scoville  
23-336-25-07 -  
23-339-25-07

25 cm / 9 7/8"  
oval, mit Hohlheft  
oval, with hollow handle  
ovalada, con mango hueco  
ovale, avec manche creux  
ovala, con manico vuoto

1/2



Simon  
23-340-03-07 - 23-340-06-07

22,5 cm / 8 7/8"  
oval, mit Hohlheft  
oval, with hollow handle  
ovalada, con mango hueco  
ovale, avec manche creux  
ovala, con manico vuoto

## Scharfe Löffel

Bone Curettes  
Cucharillas cortantes  
Curettes tranchantes  
Curette taglienti

## Knochenchirurgie

Bone Surgery  
Cirugía ósea  
Chirurgie osseuse  
Chirurgia ossea

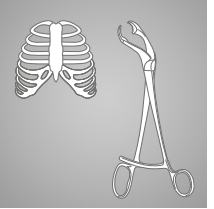

6,0 mm

Fig. 1

23-342-01-07



4,8 mm

Fig. 1

23-350-01-07



2,7 mm

Fig. 1

36-743-10-07



5,0 mm

Fig. 0

23-342-10-07



5,8 mm

Fig. 2

23-350-02-07



2,5 mm

Fig. 2

36-743-20-07



4,5 mm

Fig. 00

23-342-20-07



6,8 mm

Fig. 3

23-350-03-07



2,2 mm

Fig. 3

36-743-30-07



3,5 mm

Fig. 000

23-342-30-07



2,0 mm

Fig. 4

36-743-40-07



1/2



1/2



1/2

23-342-01-07 - 23-342-30-07

25 cm / 9 7/8"  
oval, mit Hohlheft  
oval, with hollow handle  
ovalada, con mango hueco  
ovale, avec manche creux  
ovale, con manico vuoto

Halle  
23-350-01-07 - 23-350-03-07

21 cm / 8 2/8"  
oval, biegsamer Schaft, mit Hohlheft  
oval, malleable shaft, with hollow handle  
ovalada, vástago maleable, con mango hueco  
ovale, tige malléable, avec manche creux  
ovale, gambo malleabile, con manico vuoto

Lempert  
36-743-10-07 - 36-743-50-07

21,5 cm / 8 4/8"  
scharf  
sharp  
agudo  
pointu  
acuto

## Scharfe Doppellöffel

Bone Curettes, double-ended

Cucharillas de doble extremo

Curettes doubles

Curette doppia

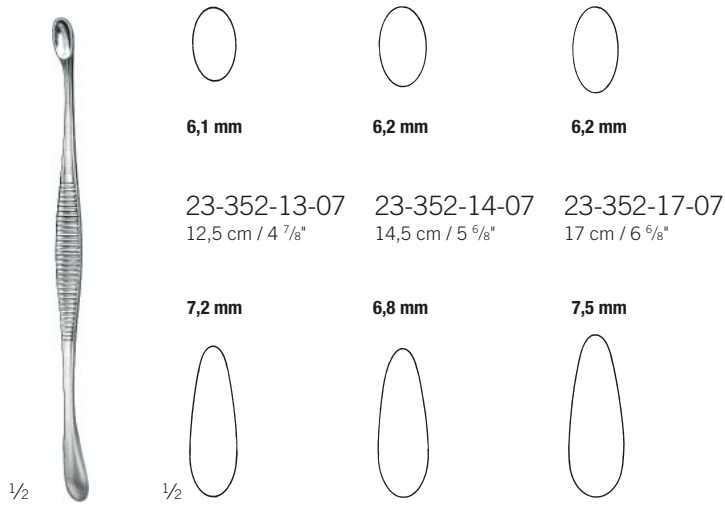

6,1 mm

6,2 mm

6,2 mm

23-352-13-07  
12,5 cm / 4 7/8"

23-352-14-07  
14,5 cm / 5 5/8"

23-352-17-07  
17 cm / 6 5/8"

7,2 mm

6,8 mm

7,5 mm

Volkman  
23-352-13-07 - 23-352-17-07



Ø 6,5 mm

6,0 mm

23-356-21-07  
21 cm / 8 2/8"

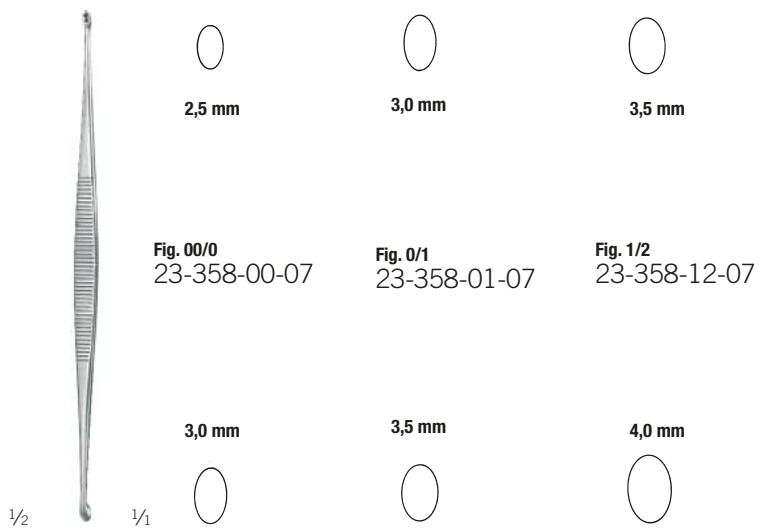

2,5 mm

3,0 mm

3,5 mm

Fig. 00/0  
23-358-00-07

Fig. 0/1  
23-358-01-07

Fig. 1/2  
23-358-12-07

3,0 mm

3,5 mm

4,0 mm

Williger  
23-358-00-07 -  
23-358-12-07  
14 cm / 5 4/8"  
oval  
oval  
ovalada  
ovale  
ovala

**Scharfe Doppellöffel**  
 Bone Currettes, double-ended  
 Cucharillas de doble extremo  
 Curettes doubles  
 Curette doppie

**Knochenchirurgie**  
 Bone Surgery  
 Cirugía ósea  
 Chirurgie osseuse  
 Chirurgia ossea

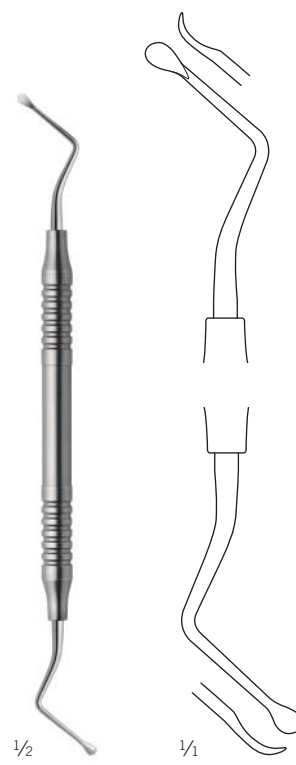
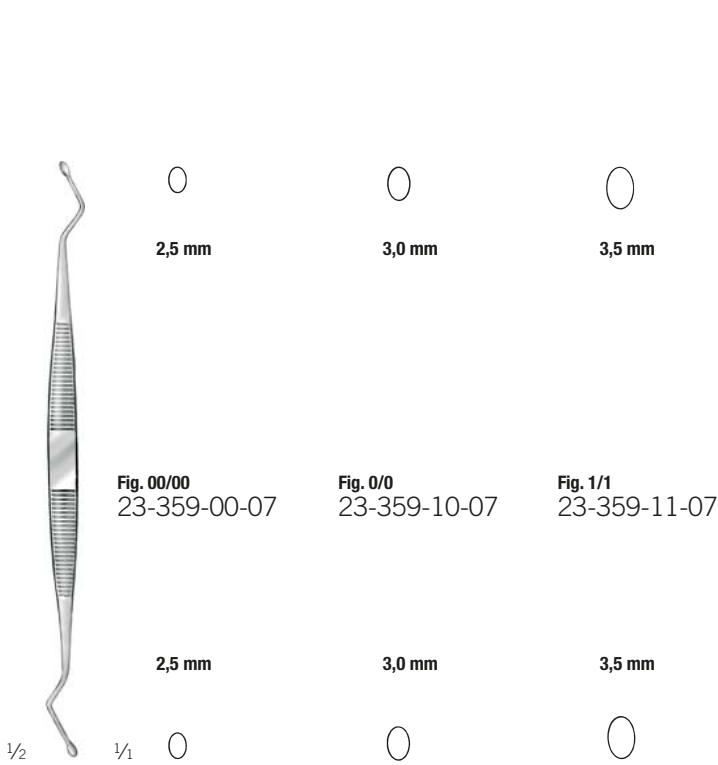
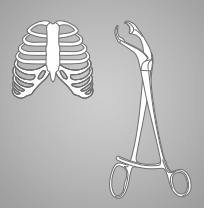

Williger  
 23-359-00-07 -  
 23-359-11-07  
 16,5 cm / 6 7/8"  
 oval  
 oval  
 ovalada  
 ovale  
 ovale

Lucas-Martin  
 23-362-11-07  
 17,5 cm / 6 7/8"  
**Fig. 1/1**

## Löffel für die zervikale Mikrodisektomie





Curettes for cervical Microdissectomy

Cucharillas para la microdissectomía cervical

Curettes pour la microdissectomie cervicale

Curette per microdissectomia cervicale

### Löffel, zervikal Curette, cervical Cucharilla, cervical Curette, cervicale Curetta, cervicale

			¼	0	0	0	0
			Fig. 1	Fig. 2	Fig. 3	Fig. 4	
¼		vorwärts gewinkelt / gerade angled forward / straight	<b>21,5 cm / 8 ½"</b>	23-997-01-07	23-997-02-07	23-997-03-07	23-997-04-07
		acodada adelante / recta angulée vers l'avant / droite angolata in avanti / diritta	<b>24 cm / 9 ½"</b>	23-997-40-07	23-997-41-07	23-997-42-07	23-997-43-07
¼		vorwärts gewinkelt / gebogen angled forward / curved	<b>21,5 cm / 8 ½"</b>	23-997-10-07	23-997-11-07	23-997-12-07	23-997-13-07
		acodada adelante / curvada angulée vers l'avant / coudée angolata in avanti / curva	<b>24 cm / 9 ½"</b>	23-997-50-07	23-997-51-07	23-997-52-07	23-997-53-07
¼		rückwärts gewinkelt / gerade angled backward / straight	<b>21,5 cm / 8 ½"</b>	23-997-20-07	23-997-21-07	23-997-22-07	23-997-23-07
		acodada atrás / recta angulée vers l'arrière / droite angolata indietro / diritta	<b>24 cm / 9 ½"</b>	23-997-60-07	23-997-61-07	23-997-62-07	23-997-63-07
¼		rückwärts gewinkelt / gebogen angled backward / curved	<b>21,5 cm / 8 ½"</b>	23-997-30-07	23-997-31-07	23-997-32-07	23-997-33-07
		acodada atrás / curvada angulée vers l'arrière / coudée angolata indietro / curva	<b>24 cm / 9 ½"</b>	23-997-70-07	23-997-71-07	23-997-72-07	23-997-73-07



½

23-997-01-07 -  
23-997-73-07

## Löffel für die lumbale Mikrodiskektomie

Curettes for lumbar Microdiscectomy  
Cucharillas para la microdissectomía lumbar  
Curettes pour la microdissectomie lumbaire  
Curette per microdissectomia lumbare

## Knochenchirurgie

Bone Surgery  
Cirugía ósea  
Chirurgie osseuse  
Chirurgia ossea

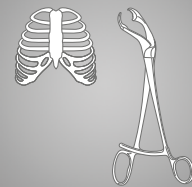

1/2

23-998-01-07 -  
23-998-52-07

### Löffel, lumbal Curette, lumbar Cucharilla, lumbar Curette, lumbaire Curetta, lombare

		1/1			
		Fig. 0	Fig. 1	Fig. 2	
1/1	vorwärts gewinkelt / gerade angled forward / straight acodada adelante / recta angulée vers l'avant / droite angolata in avanti / diritta	24 cm / 9 1/8"	23-998-01-07	23-998-02-07	23-998-03-07
1/1	vorwärts gewinkelt / gebogen angled forward / curved acodada adelante / curvada angulée vers l'avant / coudée angolata in avanti / curva	24 cm / 9 1/8"	23-998-10-07	23-998-11-07	23-998-12-07
1/1	vorwärts gewinkelt / abwärts gebogen angled forward / curved downward acodada adelante / curvada abajo angulée vers l'avant / coudée vers le bas angolata in avanti / curva verso il basso	24 cm / 9 1/8"	23-998-20-07	23-998-21-07	23-998-22-07
1/1	rückwärts gewinkelt / gerade angled backward / straight acodada atrás / recta angulée vers l'arrière / droite angolata indietro / diritta	24 cm / 9 1/8"	23-998-30-07	23-998-31-07	23-998-32-07
1/1	rückwärts gewinkelt / gebogen angled backward / curved acodada atrás / curvada angulée vers l'arrière / coudée angolata indietro / curva	24 cm / 9 1/8"	23-998-40-07	23-998-41-07	23-998-42-07
1/1	rückwärts gewinkelt / abwärts gebogen angled backward / curved downward acodada atrás / curvada abajo angulée vers l'arrière / coudée vers le bas angolata indietro / curva verso il basso	24 cm / 9 1/8"	23-998-50-07	23-998-51-07	23-998-52-07



## Raspatorien

Periosteal Elevators

Periostótomos

Rugines-raspatoires

Periostotomi

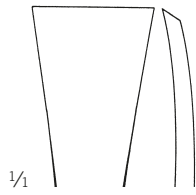

**16 mm**  
23-400-01-07  
19 cm / 7 4/8"



**7 mm**  
23-400-10-07  
16 cm / 6 2/8"

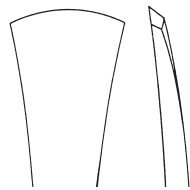

**16 mm**  
23-400-02-07  
20 cm / 7 7/8"

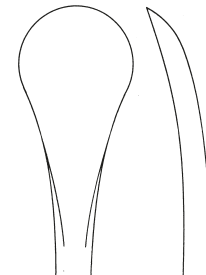

**15 mm**  
23-400-11-07  
18,5 cm / 7 2/8"

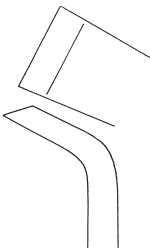

**12 mm**  
23-400-03-07  
19 cm / 7 4/8"

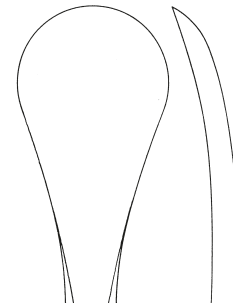

**20 mm**  
23-400-12-07  
19 cm / 7 4/8"



1/2

Martin-Langenbeck  
23-400-01-07 -  
23-400-04-07

massiv  
solid  
macizo  
solide  
pieno

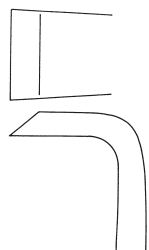

**12 mm**  
23-400-04-07  
18 cm / 7 1/8"



1/2

Martin-Hoen  
23-400-10-07 -  
23-400-12-07

massiv  
solid  
macizo  
solide  
pieno

## Raspatorien

Periosteal Elevators  
Periostótomos  
Rugines-raspatoires  
Periostotomi

## Knochenchirurgie

Bone Surgery  
Cirugía ósea  
Chirurgie osseuse  
Chirurgia ossea

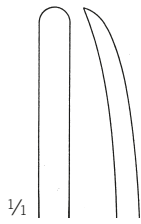
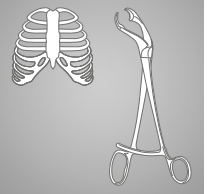

**4 mm**  
23-400-20-07  
17,5 cm / 7 "

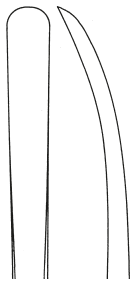

**6 mm**  
23-400-21-07  
17,5 cm / 7 "



**5 mm**  
23-400-25-07  
19,5 cm / 7 6/8"



**7 mm**  
23-400-26-07  
19,5 cm / 7 6/8"

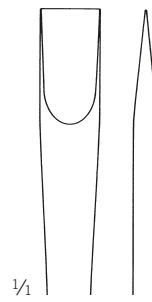

**8 mm**



1/2

Martin-Cushing  
23-400-20-07 -  
23-400-26-07

massiv  
solid  
macizo  
solide  
pieno



1/2

Martin-Cushing  
23-400-30-07

17 cm / 6 6/8"

massiv  
solid  
macizo  
solide  
pieno

## Raspatorien

Periosteal Elevators  
Periostótomos  
Rugines-raspatoires  
Periostotomi

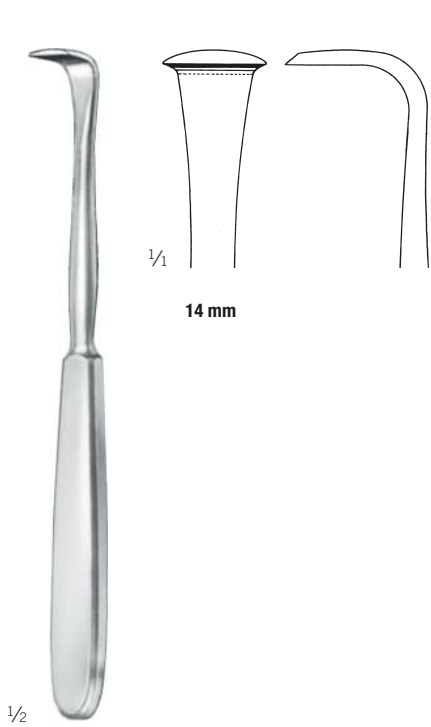

Langenbeck  
23-401-18-07  
18 cm / 7 1/8"  
mit Hohlheft  
with hollow handle  
con mango hueco  
avec manche creux  
con manico vuoto

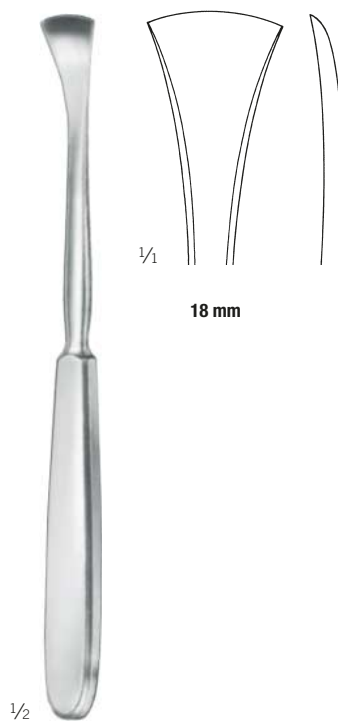

Langenbeck  
23-402-19-07  
19 cm / 7 4/8"  
mit Hohlheft  
with hollow handle  
con mango hueco  
avec manche creux  
con manico vuoto

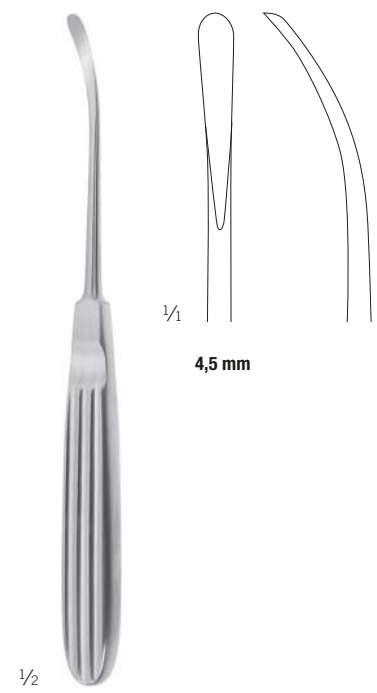

Landolt  
23-404-18-07  
17,5 cm / 6 7/8"

## Raspatorien

Periosteal Elevators  
Periostótomos  
Rugines-raspatoires  
Periostotomi

## Knochenchirurgie

Bone Surgery  
Cirugía ósea  
Chirurgie osseuse  
Chirurgia ossea

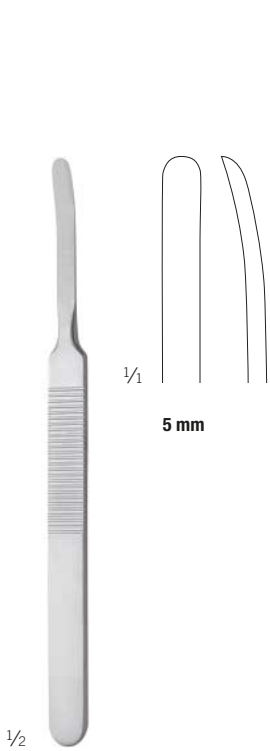
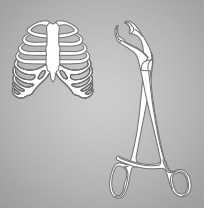

König  
23-406-16-07  
15,5 cm / 6 1/8"

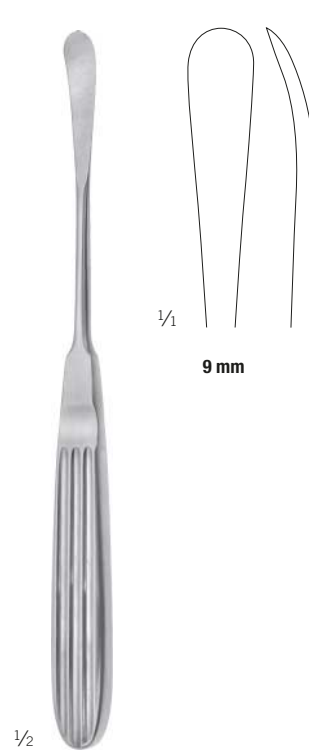

Cottle  
23-412-20-07  
19,5 cm / 7 5/8"

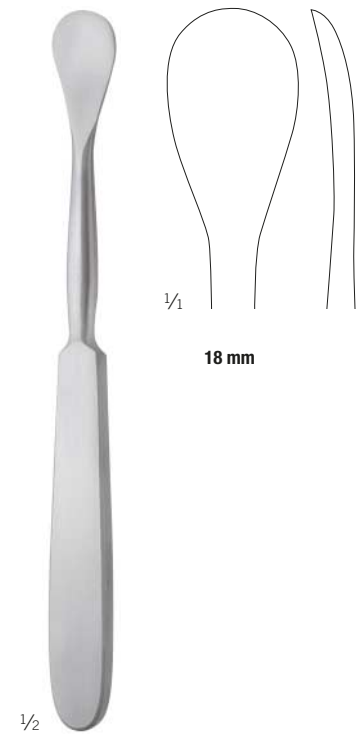

Sedillot  
23-414-19-07  
18,5 cm / 7 2/8"

## Raspatorien

Periosteal Elevators  
 Periostótomos  
 Rugines-raspatoires  
 Periostotomi

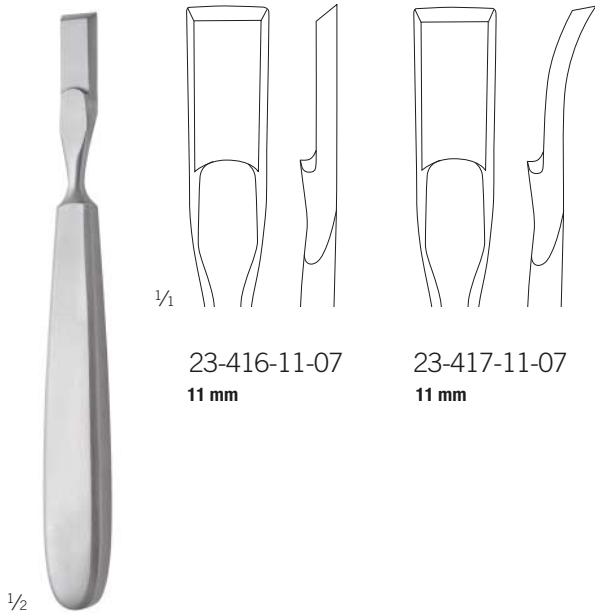

1/4

23-416-11-07  
 11 mm

23-417-11-07  
 11 mm

1/2

Farabeuf-Collin  
 23-416-11-07 - 23-417-11-07  
 15,5 cm / 6 1/8"

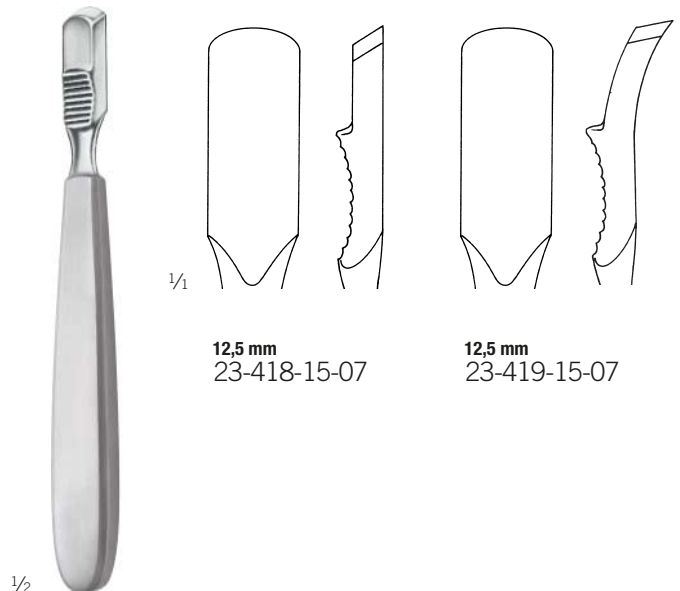

1/4

12,5 mm  
 23-418-15-07

12,5 mm  
 23-419-15-07

1/2

Farabeuf  
 23-418-15-07 -  
 23-419-15-07  
 15,5 cm / 6 1/8"  
 mit Hohlheft  
 with hollow handle  
 con mango hueco  
 avec manche creux  
 con manico vuoto



1/4

3 mm  
 23-423-06-07  
 18 cm / 7 1/8"

6,5 mm  
 23-423-01-07  
 18 cm / 7 1/8"

9,5 mm  
 23-423-02-07  
 19 cm / 7 4/8"

12,5 mm  
 23-423-03-07  
 19 cm / 7 4/8"

16 mm  
 23-423-07-07  
 20 cm / 7 7/8"

19 mm  
 23-423-04-07  
 20 cm / 7 7/8"

25,5 mm  
 23-423-05-07  
 21,5 cm / 8 4/8"

1/2

Key  
 23-423-01-07 -  
 23-423-07-07

## Raspatorien

Periosteal Elevators  
 Periostótomos  
 Rugines-raspatoires  
 Periostotomi

## Knochenchirurgie

Bone Surgery  
 Cirugía ósea  
 Chirurgie osseuse  
 Chirurgia ossea

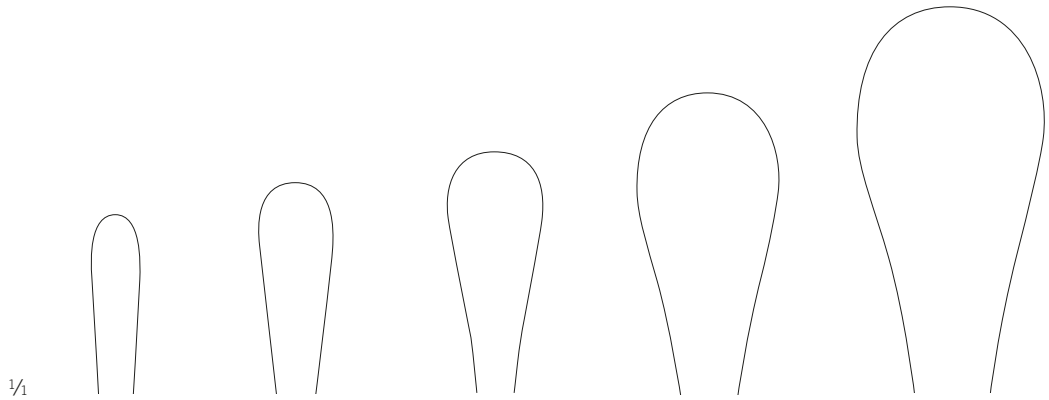
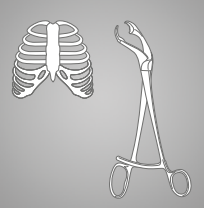

	6 mm	10 mm	13 mm	19 mm	25 mm
23 cm / 9"	23-426-06-07	23-426-10-07	23-426-13-07	23-426-19-07	23-426-25-07
28 cm / 11"	23-425-06-07	23-425-10-07	23-425-13-07	23-425-19-07	23-425-25-07

Cobb  
 23-425-06-07 -  
 23-426-25-07

1/2

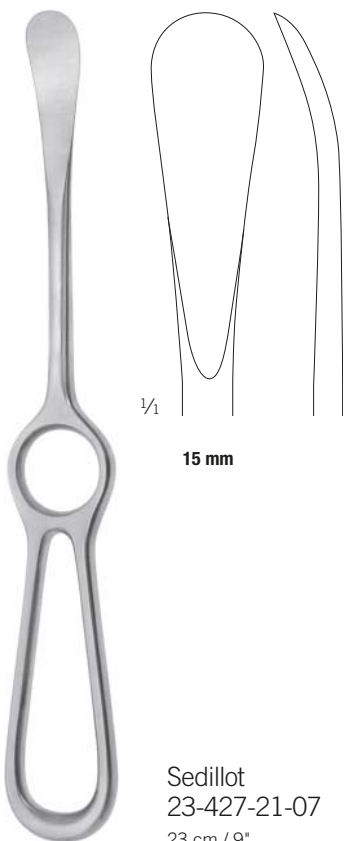

1/4

15 mm

Sedillot  
 23-427-21-07  
 23 cm / 9"

1/2

## Rasporien

Periosteal Elevators  
Periostótomos  
Rugines-raspatoirs  
Periostotomi

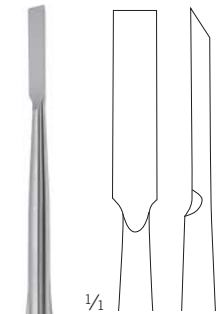

6 mm



14 mm

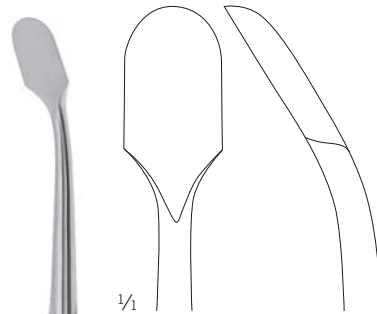

14 mm

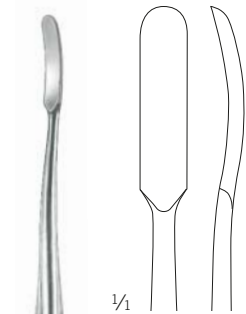

6 mm

1/2



1/2



1/2



1/2



23-428-06-04  
20 cm / 8"

Sic

23-429-14-04  
20 cm / 8"

Sic

23-432-14-04  
20 cm / 8"

Sic

23-432-18-04  
20 cm / 8"

Sic

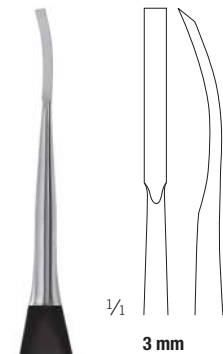

3 mm

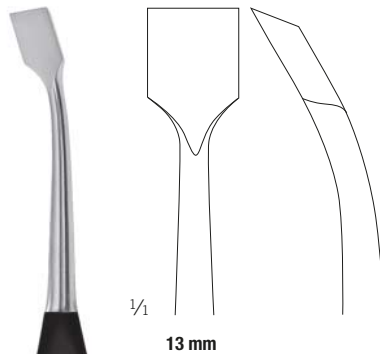

13 mm



6 mm

1/2



1/2



1/2



23-433-03-04  
20 cm / 8"

Sic

23-433-13-04  
20 cm / 8"

Sic

23-433-18-04  
20 cm / 8"

Sic

## Raspatorien

Periosteal Elevators  
Periostótomos  
Rugines-raspatoires  
Periostotomi

## Knochenchirurgie

Bone Surgery  
Cirugía ósea  
Chirurgie osseuse  
Chirurgia ossea

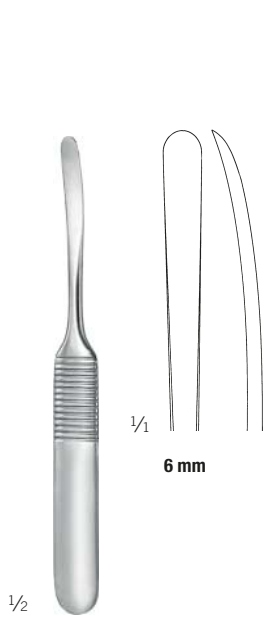
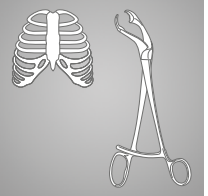

Williger  
23-434-13-07  
12,5 cm / 4 7/8"  
massiv  
solid  
macizo  
solide  
pieno

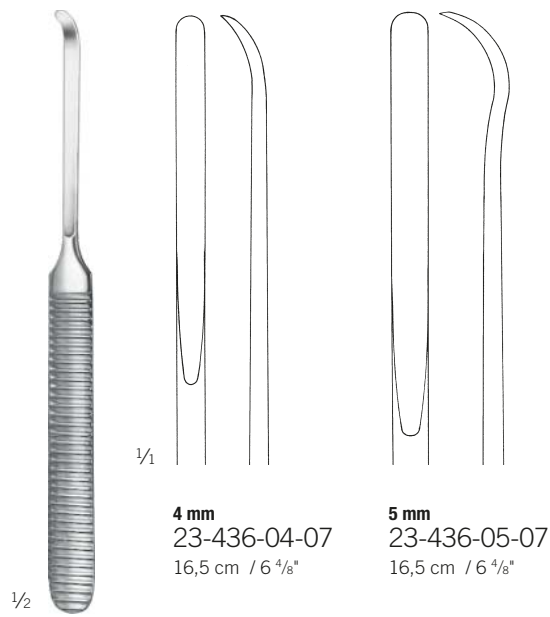

Kahre-Williger  
23-436-04-07 -  
23-436-05-07  
16,5 cm / 6 4/8"  
massiv  
solid  
macizo  
solide  
pieno

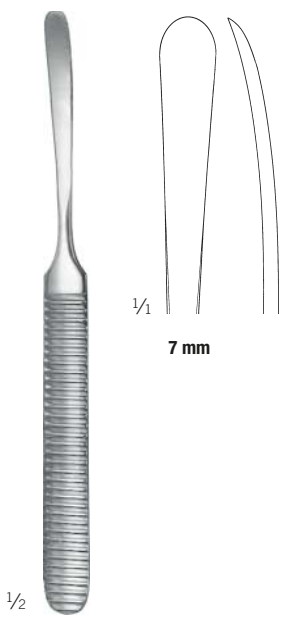

Williger  
23-436-07-07  
16 cm / 6 4/8"  
massiv  
solid  
macizo  
solide  
pieno

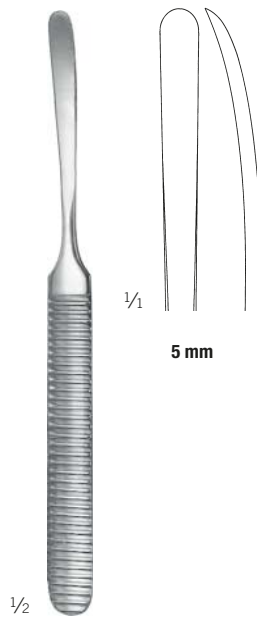

Williger  
23-436-16-07  
16 cm / 6 4/8"  
massiv  
solid  
macizo  
solide  
pieno



## Raspatorien

Periosteal Elevators  
 Periostótomos  
 Rugines-raspatoirs  
 Periostotomi

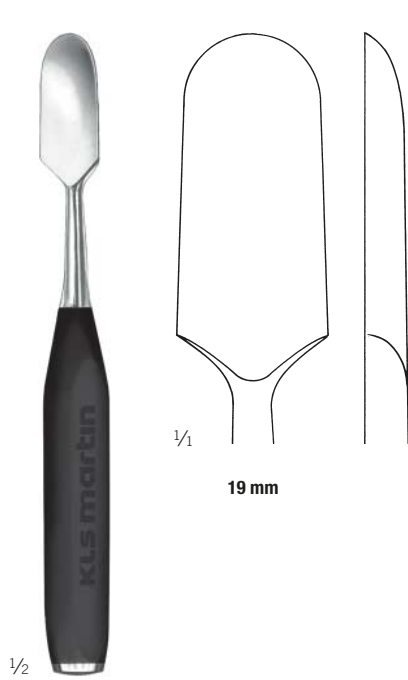

1/2

19 mm

1/2

23-437-20-04

20 cm / 7 7/8"

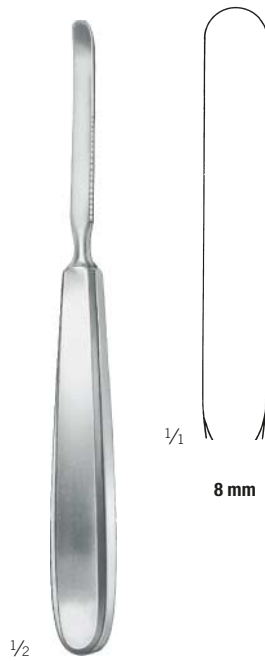

1/2

8 mm

1/2

23-439-08-07

17 cm / 6 5/8"

mit Hohlheft  
 with hollow handle  
 con mango hueco  
 avec manche creux  
 con manico vuoto



1/2

23-461-05-07

5 mm

23-461-10-07

10 mm

23-461-15-07

15 mm

1/2

23-461-20-07

20 mm

23-461-25-07

25 mm

1/2

Lambotte

23-461-05-07 - 23-461-25-07

21,5 cm / 8 1/2"

## Raspatorien

Periosteal Elevators  
Periostótomos  
Rugines-raspatoires  
Periostotomi

## Knochenchirurgie

Bone Surgery  
Cirugía ósea  
Chirurgie osseuse  
Chirurgia ossea

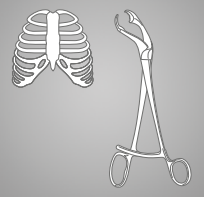

1/2

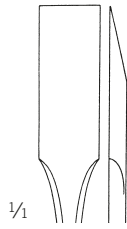

**7,9 mm**  
23-484-17-07  
17 cm / 6 5/8"

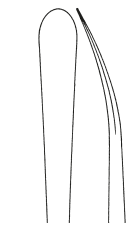

**5,0 mm**  
23-485-17-07  
17,5 cm / 6 7/8"



**7,7 mm**  
23-486-17-07  
17,5 cm / 6 7/8"

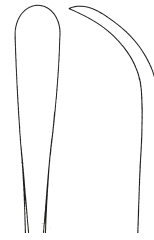

**6,3 mm**  
23-487-17-07  
17 cm / 6 5/8"

Adson  
23-484-17-07 - 23-487-17-07



1/2

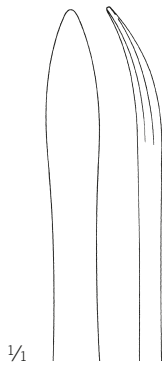

**7 mm**  
23-495-20-07  
19,5 cm / 7 5/8"



**10 mm**  
23-497-20-07  
19,5 cm / 7 5/8"

Langenbeck  
23-495-20-07 - 23-497-20-07

## Glbellaraspeln, Nasenraspeln

Glabella Rasps, Nasal Rasps

Escofinas para glabella, Escofinas nasales

Râpes pour la glabelle, Râpes nasales

Raspe per glabella, Raspe nasali



1/2

Aufricht  
37-671-21-07 -  
37-673-21-07  
21 cm / 8 2/8"

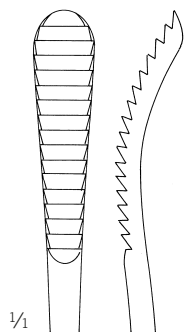

1/1

**32 x 9 mm**  
37-671-21-07  
auf Stoss schneidend  
pushing cut  
cortante a empuje  
tranchante à impact  
tagliente a urto

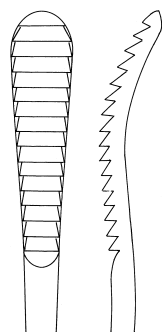

**32 x 9 mm**  
37-673-21-07  
auf Zug schneidend  
drawing cut  
cortante a tracción  
tranchante à traction  
tagliente a trazione



1/2

Lewis  
37-674-18-07 -  
37-676-18-07  
19 cm / 7 4/8"

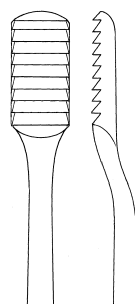

1/1

**15 x 8 mm**  
37-674-18-07  
auf Zug schneidend  
drawing cut  
cortante a tracción  
tranchante à traction  
tagliente a trazione

feine Zahnung  
delicate serration  
dentado fina  
denture fine  
dentatura delicata

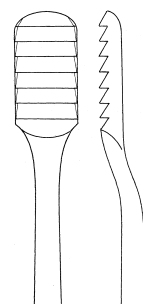

**15 x 8 mm**  
37-676-18-07  
auf Zug schneidend  
drawing cut  
cortante a tracción  
tranchante à traction  
tagliente a trazione

grobe Zahnung  
coarse serration  
dentado grueso  
denture grossière  
dentatura grossolana



1/2

**7,0 mm**  
Fomon  
37-680-21-07  
20,5 cm / 8 1/8"



1/1



# Nasenraspeln

Nasal Rasps  
Escofinas nasales  
Râpes nasales  
Raspe nasali

# Knochenchirurgie

Bone Surgery  
Cirugía ósea  
Chirurgie osseuse  
Chirurgia ossea

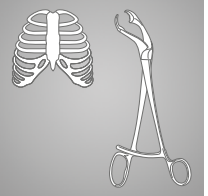

## TC GOLD

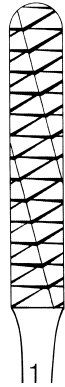
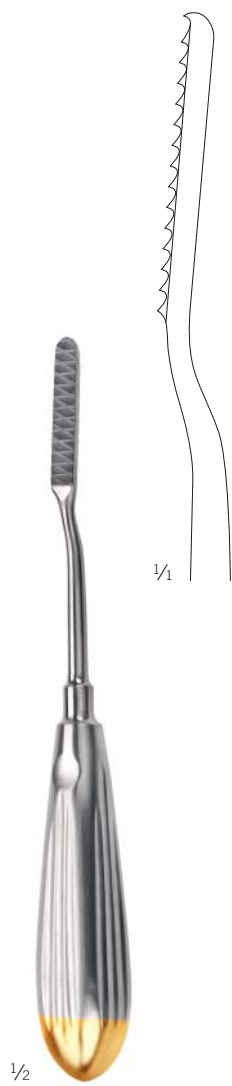

Fig. 1  
37-680-01-07

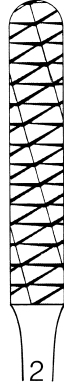

Fig. 2  
37-680-02-07



Fig. 3  
37-680-03-07

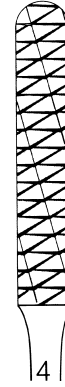

Fig. 4  
37-680-04-07



Fig. 5  
37-680-05-07

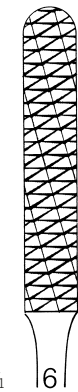

Fig. 6  
37-680-06-07



Fig. 7  
37-680-07-07



Fig. 8  
37-680-08-07

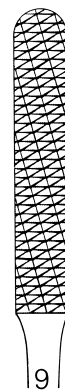

Fig. 9  
37-680-09-07



Fig. 10  
37-680-10-07

7,0 mm  
Maltz  
37-680-01-07 -  
37-680-10-07  
21 cm / 8 2/8"

# Nasenraspeln

Nasal Rasps  
Escofinas nasales  
Râpes nasales  
Raspe nasali

## TC GOLD

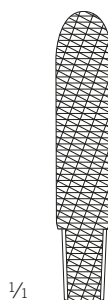

**Fig. 1**  
37-681-01-07  
7 mm



**Fig. 2**  
37-681-02-07  
7 mm



**Fig. 3**  
37-681-03-07  
7 mm

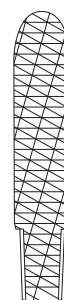

**Fig. 4**  
37-681-04-07  
7 mm

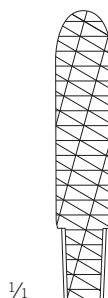

**Fig. 5**  
37-681-05-07  
7 mm

### 37-681-11-07

14 cm / 5 5/8"

Handgriff für TC-Raspeleinsatz  
Handle for TC Inserts  
Mango para escofina TC  
Poignée pour insert de râpe CT  
Manico per inserto raspa TC



**Fig. 6**  
37-681-06-07  
7 mm

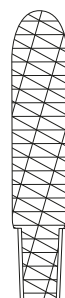

**Fig. 7**  
37-681-07-07  
7 mm

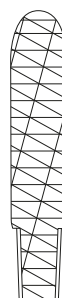

**Fig. 8**  
37-681-08-07  
7 mm



**Fig. 9**  
37-681-09-07  
7 mm



**Fig. 10**  
37-681-10-07  
7 mm



1/2

### 37-681-12-07

15 cm / 5 7/8"

Handgriff für TC-Raspeleinsatz, doppelt  
Handle for TC Inserts, double  
Mango escofina TC, doble extremo  
Poignée pr insert râpe CT, double  
Manico per inserto raspa TC, doppio



1/2

### 37-681-13-07

Schlüssel für Handgriff  
Key for handle  
Llave para mango  
Clé pour poignée  
Chiave per manico



37-681-11-07,  
37-681-12-07

# Nasenraspeln

Nasal Rasps  
Escofinas nasales  
Râpes nasales  
Raspe nasali

# Knochenchirurgie

Bone Surgery  
Cirugía ósea  
Chirurgie osseuse  
Chirurgia ossea

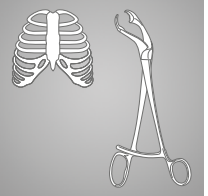

## TC GOLD

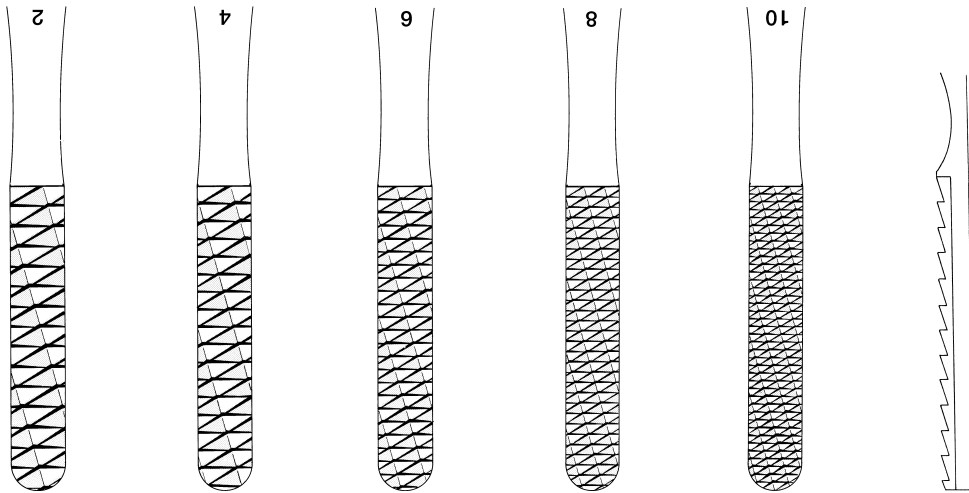
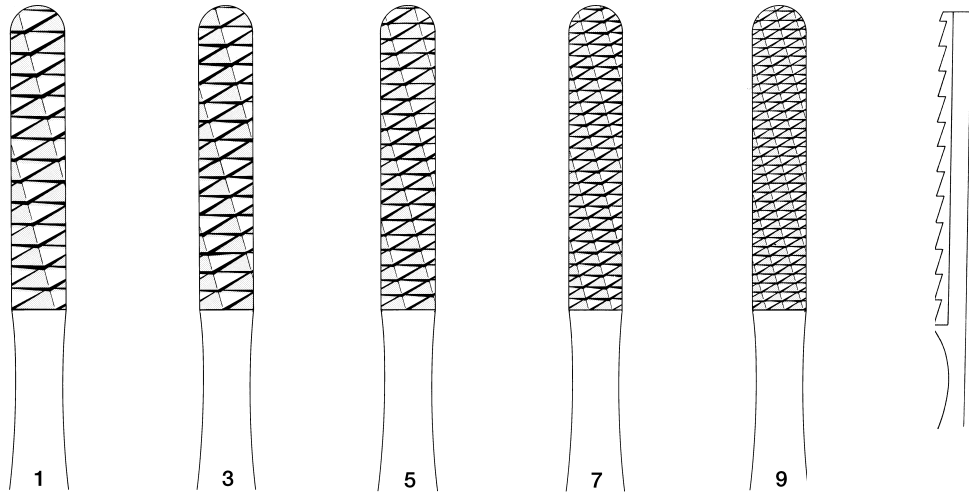

Fig. 1/2  
37-682-01-07  
30 x 8 mm

Fig. 3/4  
37-682-02-07  
40 x 7 mm

Fig. 5/6  
37-682-03-07  
40 x 7 mm

Fig. 7/8  
37-682-04-07  
40 x 7 mm

Fig. 9/10  
37-682-05-07  
40 x 7 mm



Fomon  
37-682-01-07 - 37-682-05-07  
20,5 cm / 8 1/8"

## Elevatorien

Elevators  
Elevadores  
Elévateurs  
Elevatori



1/2



1/1

**5 mm**  
23-499-01-07  
17 cm / 6 5/8"



**7 mm**  
23-499-02-07  
17 cm / 6 5/8"



**8 mm**  
23-499-03-07  
19,5 cm / 7 5/8"



**10 mm**  
23-499-04-07  
19,5 cm / 7 5/8"

Martin-Langenbeck  
23-499-01-07 -  
23-499-04-07

massiv  
solid  
macizo  
solide  
pieno



1/2



1/1

**7 mm**



1/2

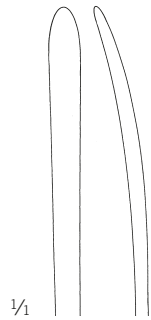

1/1

**4 mm**

Williger  
23-510-17-07  
17 cm / 6 5/8"

massiv  
solid  
macizo  
solide  
pieno

Williger  
23-513-16-07  
16 cm / 6 2/8"

massiv  
solid  
macizo  
solide  
pieno

## Elevatorien, Doppeldissektoren

Elevators, Dissectors, double-ended

Elevadores, Disectores dobles

Elévateurs, Dissecteurs doubles

Elevatori, Dissettori doppi

## Knochenchirurgie

Bone Surgery

Cirugía ósea

Chirurgie osseuse

Chirurgia ossea

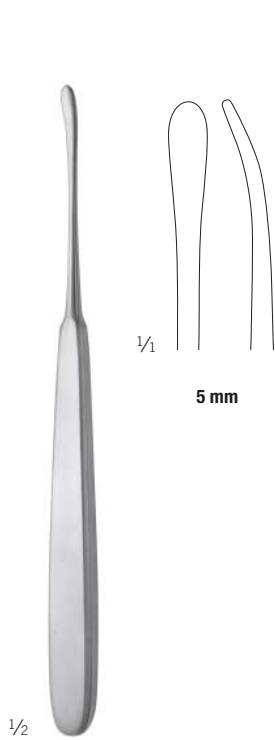
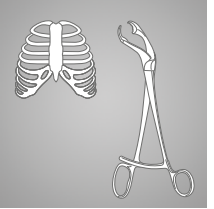

Sebileau  
23-516-18-07  
17,5 cm / 6 7/8"

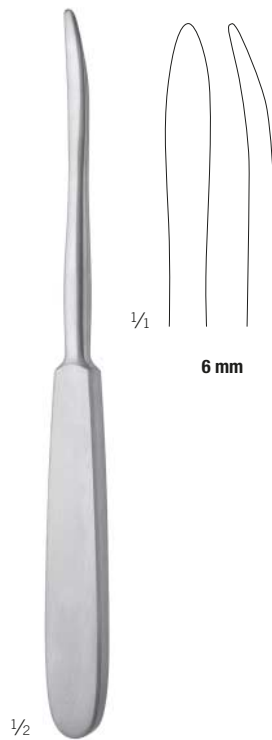

Quervain  
23-517-20-07  
19,5 cm / 7 5/8"

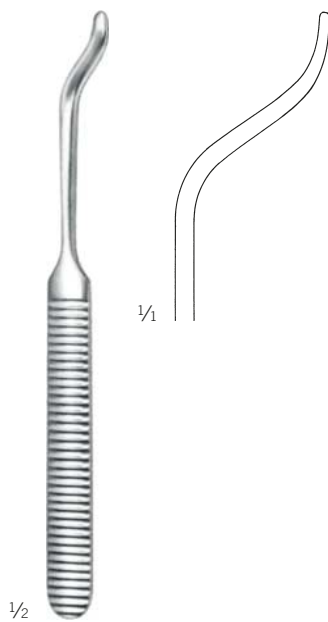

23-523-16-07  
16 cm / 6 2/8"  
Phalangenhebel  
Phalangeal elevator  
Elevador para falanges  
Elévateur pour phalanges  
Divaricatore per falange

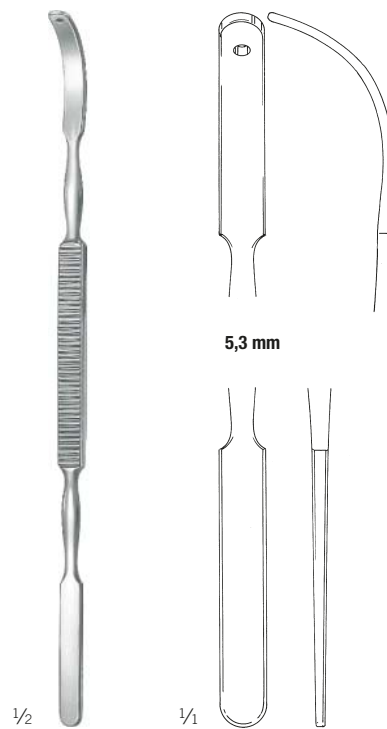

McDonald  
23-527-19-07  
18,5 cm / 7 2/8"



## Septumelevatorien

Septum Elevators

Elevadores para tabique nasal

Élévateurs pour la cloison nasale

Elevatori per il setto nasale

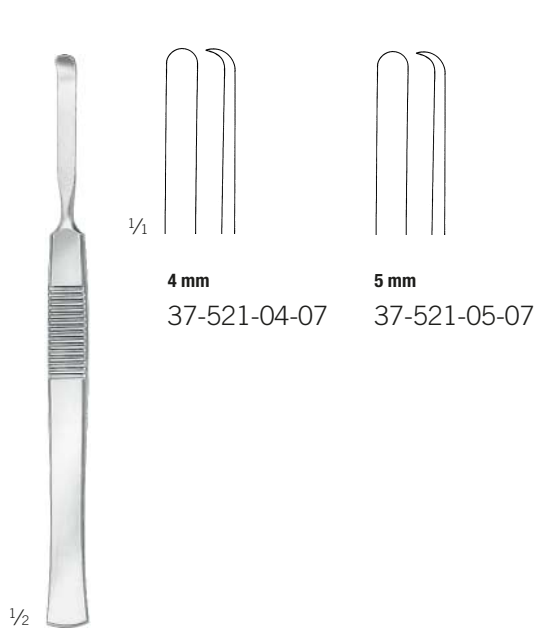

1/2

4 mm

37-521-04-07

5 mm

37-521-05-07

1/2

McKenty

37-521-04-07 -

37-521-05-07

15 cm / 5 7/8"

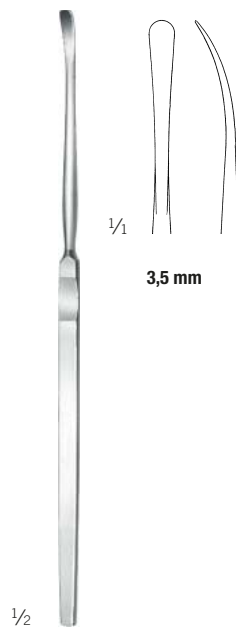

1/2

3,5 mm

1/2

Halle

37-525-16-07

16 cm / 6 2/8"

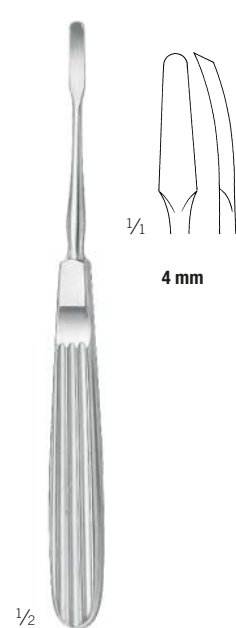

1/2

4 mm

1/2

Joseph

37-531-16-07

16,5 cm / 6 4/8"

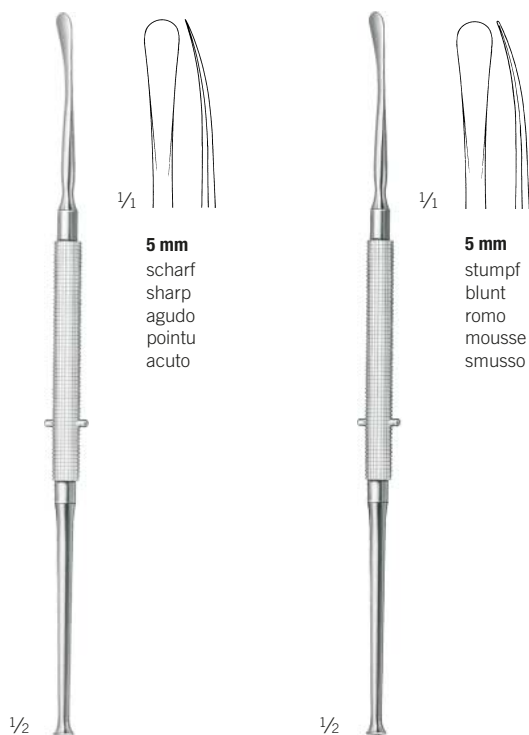

1/2

5 mm

scharf  
sharp  
agudo  
pointu  
acuto

1/2

5 mm

stumpf  
blunt  
romo  
mousse  
smusso

1/2

Freer

37-541-19-07

19 cm / 7 4/8"

1/2

Freer

37-543-19-07

19 cm / 7 4/8"



5 mm

ohne Stift im Griff, scharf / stumpf  
without pin in handle, sharp / blunt  
sin perno en mango, agudo/romo  
sans boulon dans la manche,  
aigu/mousse  
senza perno nella manico,  
tagliante/smussato

5 mm

1/2

Freer

37-545-18-07

18 cm / 7 1/8"

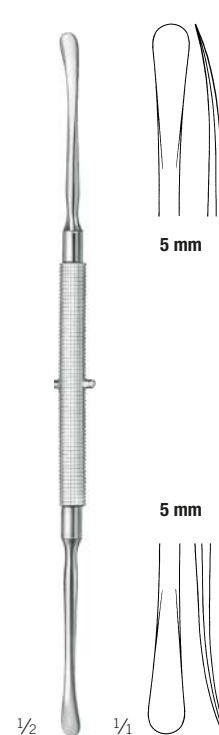

5 mm

5 mm

1/2

Freer

37-546-18-07

18 cm / 7 1/8"

## Septumlevatorien

Septum Elevators

Elevadores para tabique nasal

Élévateurs pour la cloison nasale

Elevatori per il setto nasale

## Knochenchirurgie

Bone Surgery

Cirugía ósea

Chirurgie osseuse

Chirurgia ossea

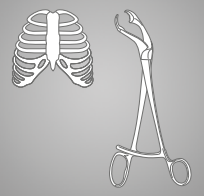

Freer  
37-547-20-07  
21 cm / 8 2/8"



McKenty  
37-549-22-07  
20,5 cm / 8 1/8"

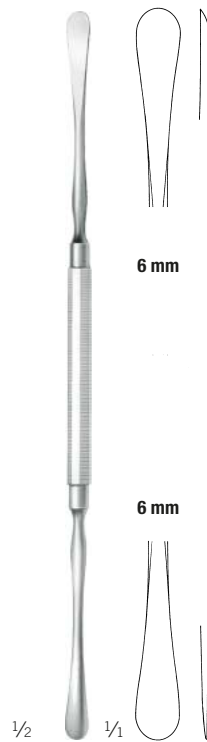

Ballenger-Hajek  
37-550-19-07  
19 cm / 7 4/8"

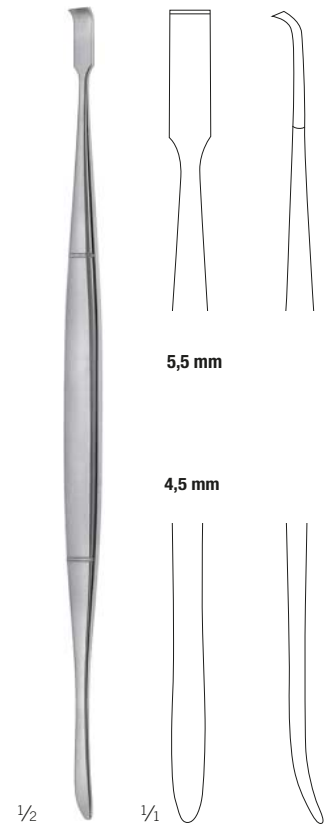

Howard  
37-557-22-07  
21,5 cm / 8 4/8"

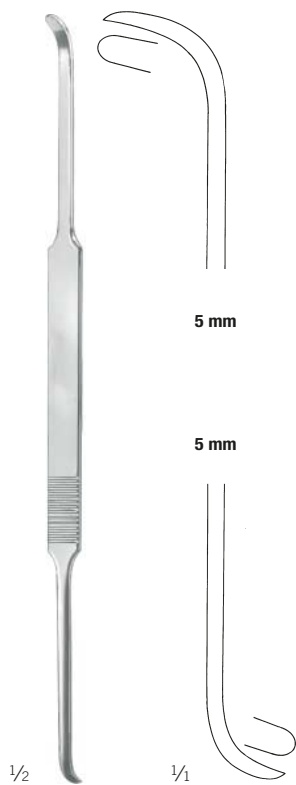

Cottle  
37-559-23-07  
23,5 cm / 9 2/8"

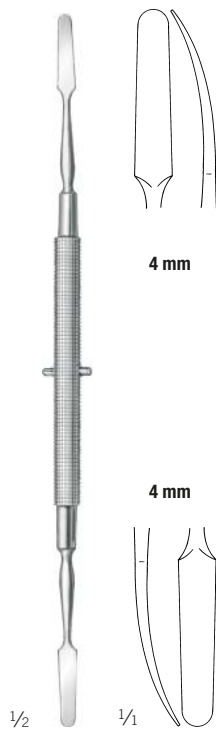

Killian  
37-560-18-07  
18 cm / 7 1/8"

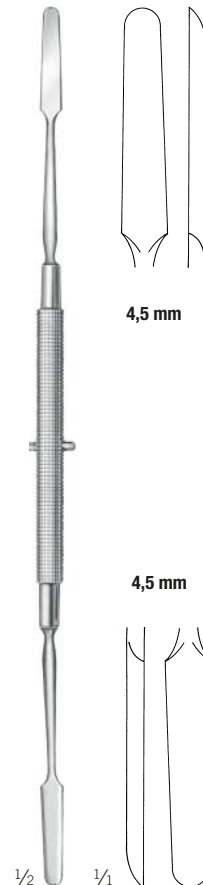

Killian  
37-562-22-07  
23,5 cm / 9 2/8"

## Periostelevatorien

Periosteal Elevators

Legras para periostio

Élévateurs pour le périoste

Elevatori per il periostio

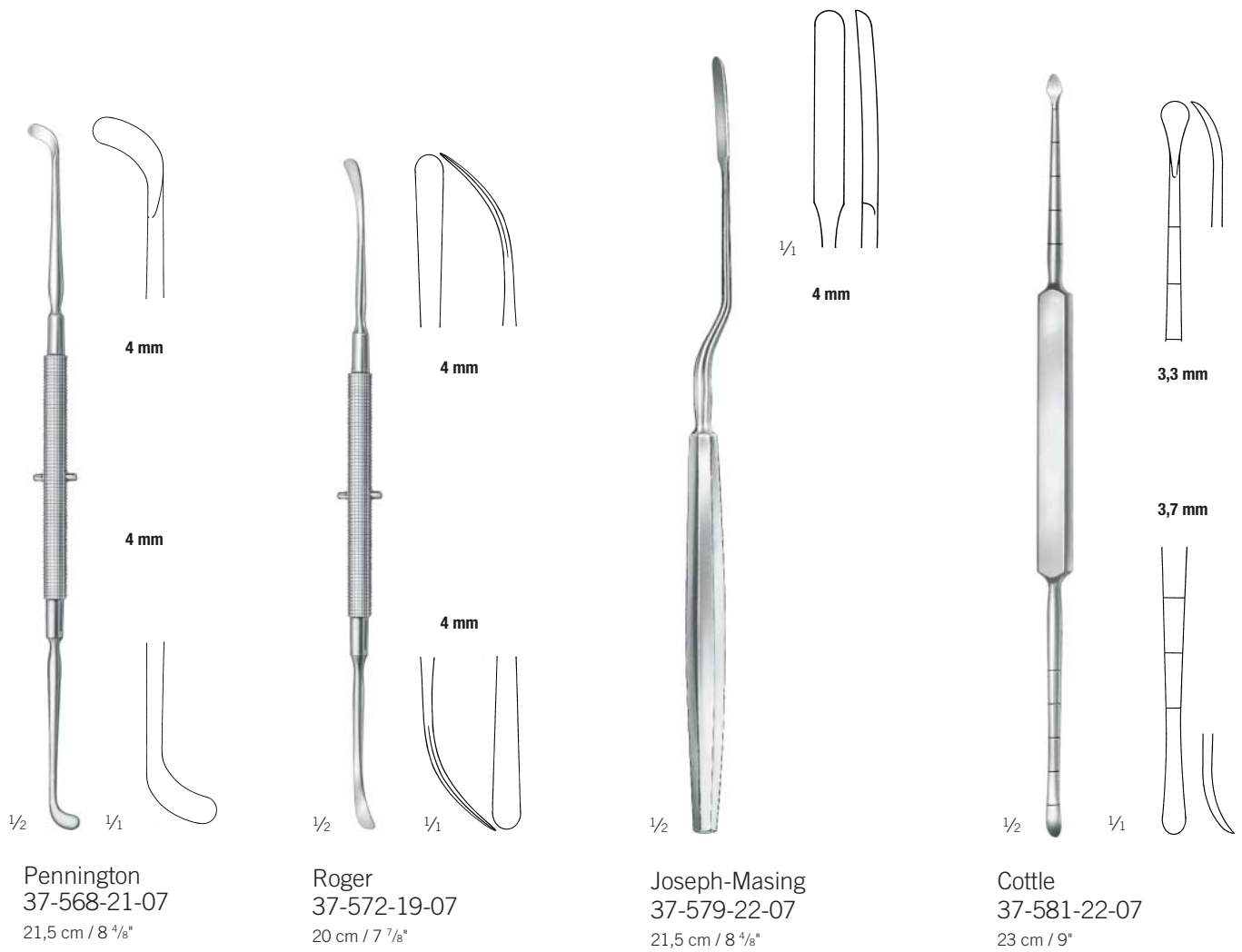

## Periostelevatorien

Periosteal Elevators

Legras para periostio

Élévateurs pour le périoste

Elevatori per il periosto

## Knochenchirurgie

Bone Surgery

Cirugía ósea

Chirurgie osseuse

Chirurgia ossea

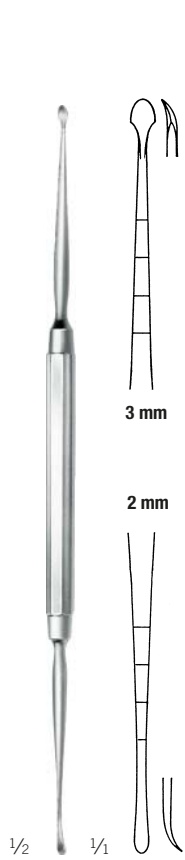
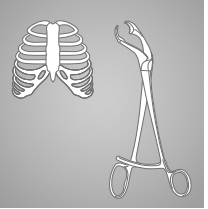

Masing  
37-583-21-07  
19,5 cm / 7 5/8"

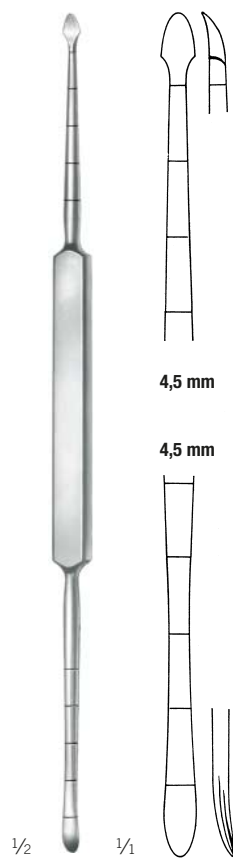

Cottle  
37-584-21-07  
22 cm / 8 5/8"

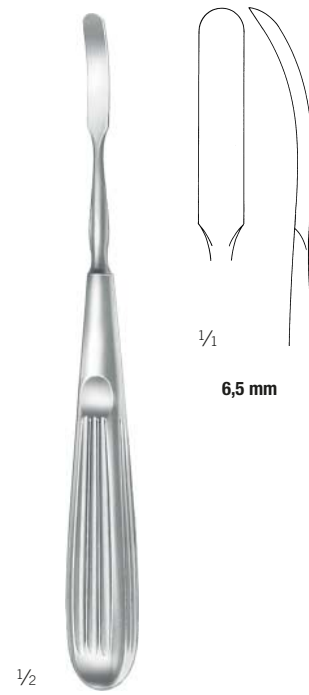

Joseph  
37-585-16-07  
18 cm / 7 1/8"

## Hohlmeißelzangen

Bone Rongeurs

Pinzas gubias

Pinces-gouges

Pinze-sgorbie



23-777-01-07  
17 cm / 6 <sup>5</sup>/<sub>8</sub>"

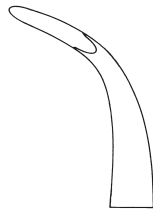

23-777-02-07  
16,5 cm / 6 <sup>4</sup>/<sub>8</sub>"

1/2

Stellbrink  
23-777-01-07 - 23-777-02-07



1/2

Friedmann  
23-801-14-07  
13,5 cm / 5 <sup>3</sup>/<sub>8</sub>"



1/2

Mead  
23-815-16-07  
16,5 cm / 6 <sup>4</sup>/<sub>8</sub>"

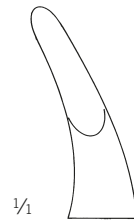

1/2

Hartmann  
23-819-18-07  
17,5 cm / 6 <sup>7</sup>/<sub>8</sub>"

## Hohlmeißelzangen

Bone Rongeurs  
Pinzas gubias  
Pincès-gouges  
Pinze-sgorbie

## Knochenchirurgie

Bone Surgery  
Cirugía ósea  
Chirurgie osseuse  
Chirurgia ossea

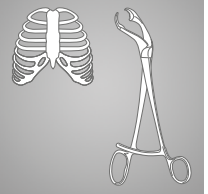

3/4



1/4

23-826-18-07  
18 cm / 7 1/8"

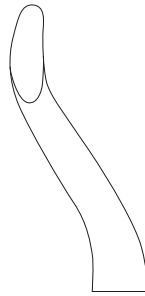

23-828-18-07  
18,5 cm / 7 3/8"



23-829-18-07  
18 cm / 7 1/8"

Jansen  
23-826-18-07 - 23-829-18-07



3/4

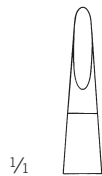

1/4

23-832-19-07



23-833-19-07

Lempert  
23-832-19-07 - 23-833-19-07  
19 cm / 7 4/8"

## Hohlmeißelzangen

Bone Rongeurs

Pinzas gubias

Pinces-gouges

Pinze-sgorbie

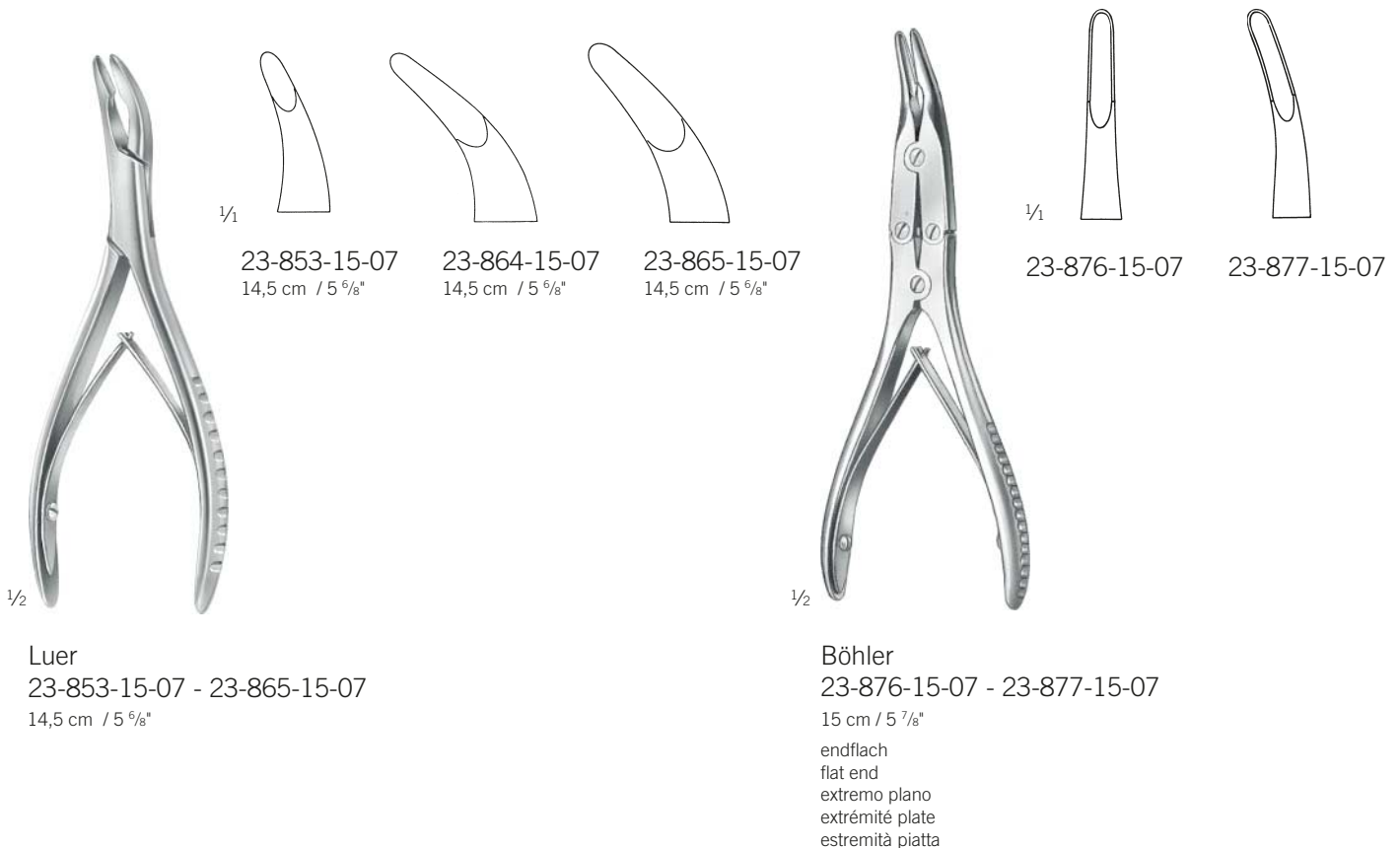
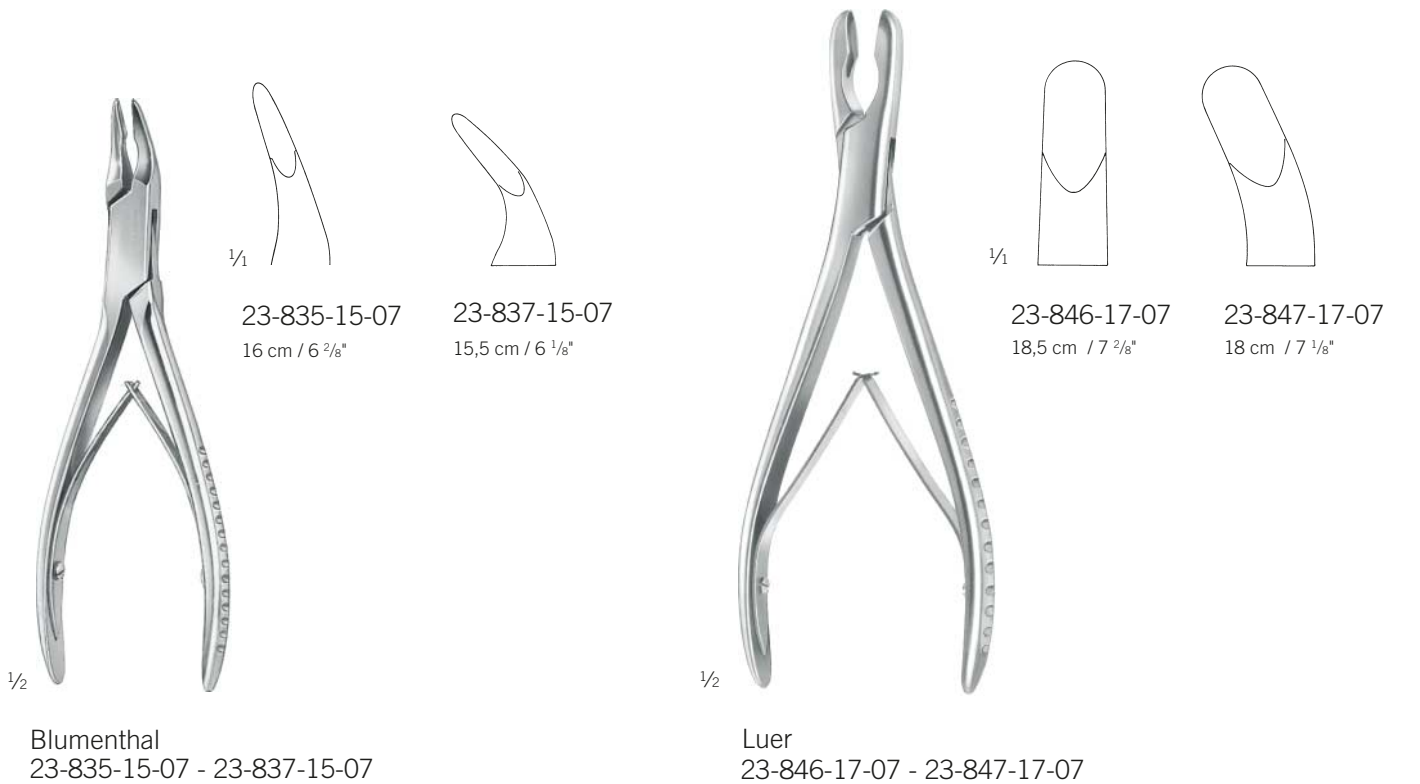

## Hohlmeißelzangen

Bone Rongeurs  
Pinzas gubias  
Pincès-gouges  
Pinze-sgorbie

## Knochenchirurgie

Bone Surgery  
Cirugía ósea  
Chirurgie osseuse  
Chirurgia ossea

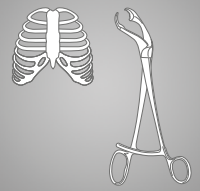

Beyer  
23-879-18-07  
18 cm / 7 1/8"



Zaufal-Jansen  
23-881-18-07  
18 cm / 7 1/8"



Mayfield  
23-883-17-07  
18 cm / 7 1/8"



Marquard  
23-885-20-07  
20,5 cm / 8 1/8"



Ruskin  
23-887-18-07  
19 cm / 7 4/8"



## Hohlmeißelzangen

Bone Rongeurs

Pinzas gubias

Pinces-gouges

Pinze-sgorbie



Ruskin  
23-893-23-07  
24 cm / 9 4/8"

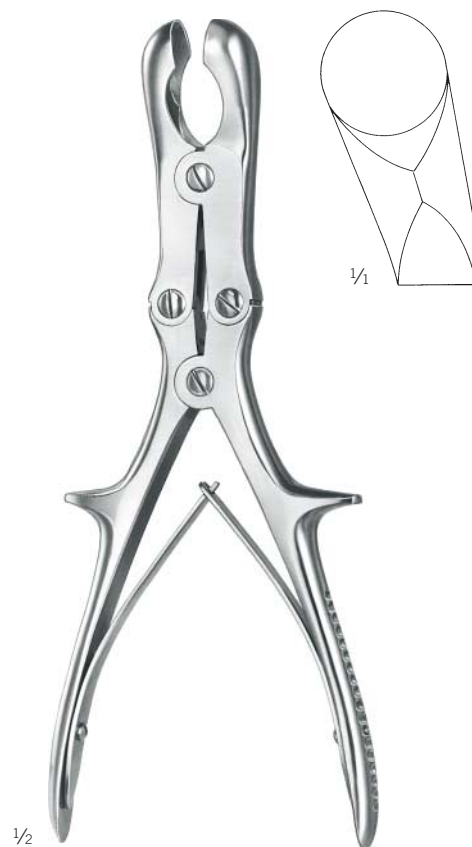

Semb  
23-895-22-07  
23,5 cm / 9 2/8"



Stille  
23-897-23-07  
22,5 cm / 8 7/8"

## Hohlmeißelzangen

Bone Rongeurs  
Pinzas gubias  
Pincers-gouges  
Pinze-sgorbie

## Knochenchirurgie

Bone Surgery  
Cirugía ósea  
Chirurgie osseuse  
Chirurgia ossea

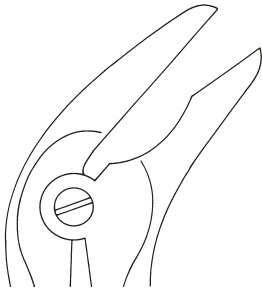
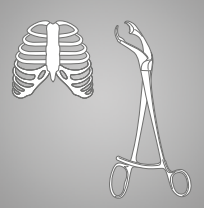

1/2

Echlin

23-899-02-07 - 23-899-04-07

23 cm / 9"

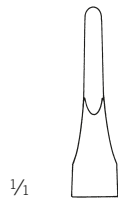

1/1

23-899-02-07



23-899-03-07



23-899-04-07



1/2

Stille-Ruskin

23-901-23-07

23,5 cm / 9 2/8"



1/1

## Hohlmeißelzangen

Bone Rongeurs

Pinzas gubias

Pinces-gouges

Pinze-sgorbie



Leksell-Stille  
23-905-24-07 -  
23-907-24-07  
24,5 cm / 9 5/8"



Frykholm  
23-909-24-07  
24,5 cm / 9 5/8"

## Hohlmeißelzangen, Knochensplitterzangen

Bone Rongeurs, Bone Cutting Forceps  
Pinzas gubias, Pinzas cortantes para hueso  
Pincers-gouges, Pincers coupantes à os  
Pinze-sgorbie, Cesioie per ossa

## Knochenchirurgie

Bone Surgery  
Cirugía ósea  
Chirurgie osseuse  
Chirurgia ossea

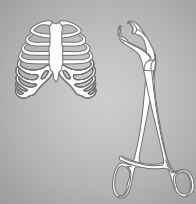

Stille-Luer  
23-910-22-07 - 23-911-22-07  
22,5 cm / 8 7/8"

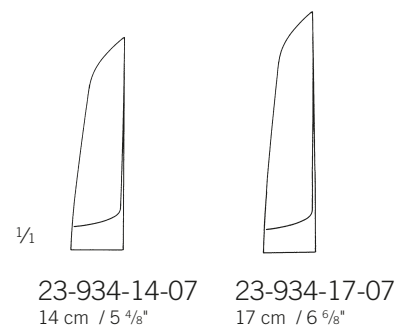

Liston  
23-934-14-07 -  
23-934-22-07

## Knochensplitterzangen

Bone Cutting Forceps

Pinzas cortantes para hueso

Pinces coupantes à os

Cesoie per ossa



Liston  
23-935-14-07 -  
23-935-22-07

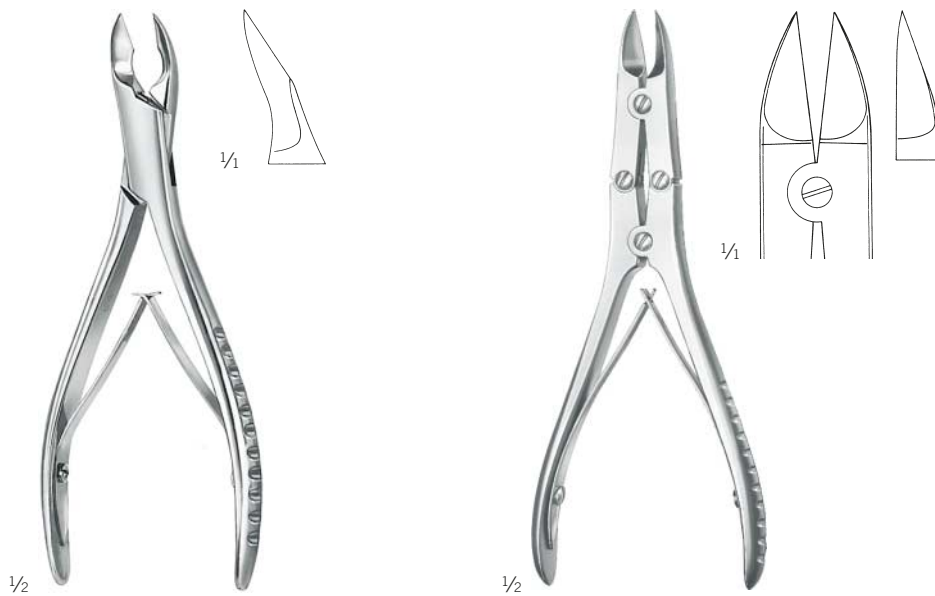

Cleveland  
23-941-15-07  
14,5 cm / 5 5/8"

Böhler  
23-946-15-07  
14,5 cm / 5 5/8"

## Knochensplitterzangen

Bone Cutting Forceps  
Pinzas cortantes para hueso  
Pincers coupantes à os  
Cesoie per ossa

## Knochenchirurgie

Bone Surgery  
Cirugía ósea  
Chirurgie osseuse  
Chirurgia ossea

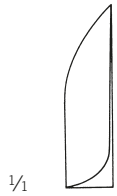
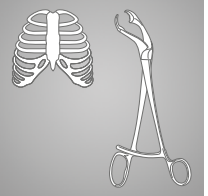

23-950-18-07  
19 cm / 7 4/8"



23-951-18-07  
18,5 cm / 7 2/8"



Ruskin-Liston  
23-950-18-07 -  
23-951-18-07



Stille-Liston  
23-955-23-07 -  
23-955-27-07

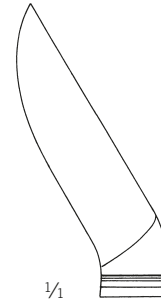

23-955-23-07  
23,5 cm / 10 2/8"



23-955-27-07  
28 cm / 11 "

## Drahtsägen, Schädelzangen

Wire Saws, Cranial Rongeurs

Sierras de hilo, Pinzas sacabocados craneales

Fils-scies, Pincers emporte-pièces crâniennes

Fili sega, Pinze per craniectomia



1/2

24-600-30-07  
30 cm / 11 5/8"

24-600-40-07  
40 cm / 15 5/8"

24-600-50-07  
50 cm / 19 5/8"

24-600-60-07  
60 cm / 23 5/8"

24-600-70-07  
70 cm / 27 1/8"

Gigli  
24-600-30-07- 24-600-70-07



1/2

Gigli  
24-602-01-01



1/2

De Martel  
24-618-33-07

33 cm / 13"

Einführinstrument

Wire saw guide

Conductor para sierras de hilo

Conducteur pour fils-scies

Introduttore



1/2

Dahlgren  
24-654-20-07

19,5 cm / 7 5/8"

mit 3 Haken  
with 3 hooks  
con 3 ganchos  
avec 3 crochets  
con 3 ganci



1/2

De Vilbiss  
24-658-21-07

21 cm / 8 2/8"

mit 2 Haken  
with 2 hooks  
con 2 ganchos  
avec 2 crochets  
con 2 ganci

## Clips und Anlegezangen

Clips and Applying Forceps  
Grapas y pinzas aplicadoras  
Clips et pinces pour appliquer  
Agrafes e pinze per applicare

## Knochenchirurgie

Bone Surgery  
Cirugía ósea  
Chirurgie osseuse  
Chirurgia ossea

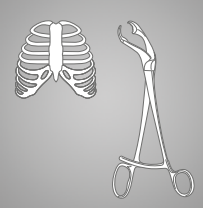

1/1

Raney  
24-675-00-07

Kopfhautklammer  
Scalp clip  
Grapa para cuero cabelludo  
Agrafes pour cuir chevelu  
Pinze per il cuoio capelluto



1/2

Raney  
24-676-00-07

15,5 cm / 6"  
Anlege- und Abnehmzange  
Applying/removal forceps  
Pinza para aplicar y quitar agrafes  
Pince pour appliquer et enlever les  
clips hémostatiques  
Pinza per applicare e togliere le agrafe  
emostatiche



1/2

Yasargil  
24-678-01-07 - 24-678-02-07

Galeahaken  
Galea hook  
Gancho Galea  
Ecarteur Galea  
Divaricatore Galea



24-678-01-07  
30 cm / 11 5/8"



1/1

24-678-02-07  
41 cm / 16 1/8"



## Dissektoren

Dissectors  
Disecadores  
Dissecteurs  
Dissettori

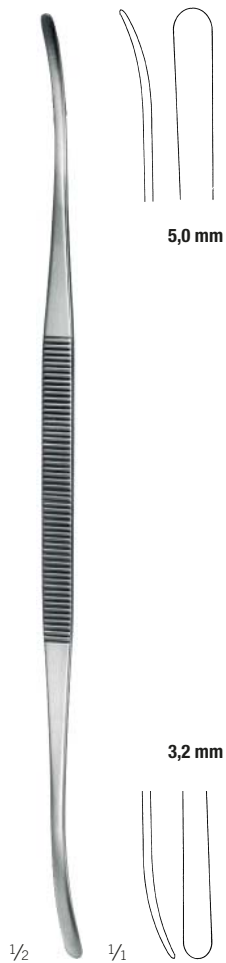

5,0 mm

3,2 mm

1/2 1/1

Toennis  
24-680-25-07  
24 cm / 9 4/8"

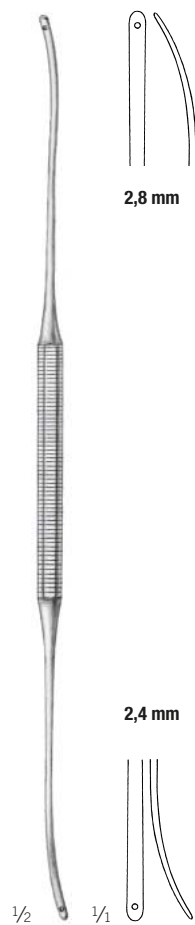

2,8 mm

2,4 mm

1/2 1/1

Olivecrona  
24-681-24-07  
24 cm / 9 4/8"



2,4 mm

2,7 mm

1/2 1/1

Olivecrona  
24-682-18-07  
18 cm / 7 1/8"

## Dissektoren

Dissectors  
Disecadores  
Dissecteurs  
Dissettori

## Knochenchirurgie

Bone Surgery  
Cirugía ósea  
Chirurgie osseuse  
Chirurgia ossea

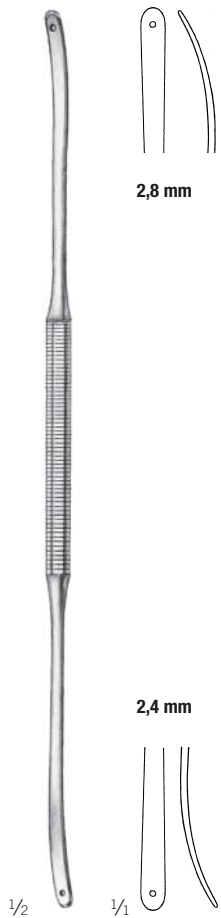
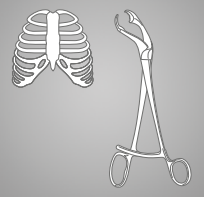

Olivecrona  
24-683-24-07  
24 cm / 9 <sup>1</sup>/<sub>8</sub>"



Olivecrona  
24-684-19-07  
20 cm / 7 <sup>7</sup>/<sub>8</sub>"



Sachs  
24-685-21-07  
20,5 cm / 8 <sup>1</sup>/<sub>8</sub>"

## Dissektoren

Dissectors  
Disecadores  
Dissecteurs  
Dissettori

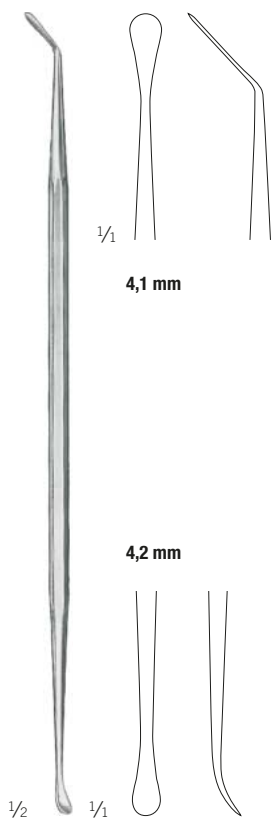

Milligan  
24-686-21-07  
21,5 cm / 8 5/8"

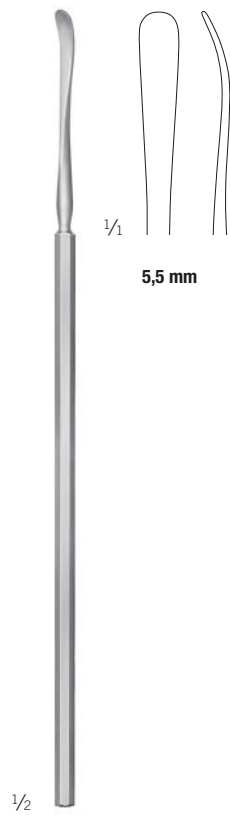

Davis  
24-687-21-07  
21,5 cm / 8 4/8"

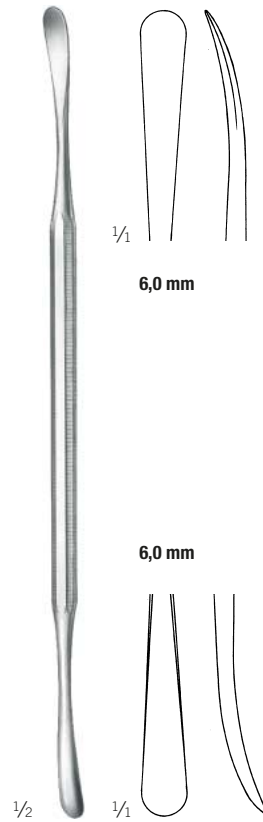

24-688-22-07  
22 cm / 8 5/8"



Davis  
24-691-24-07  
24,5 cm / 9 5/8"

# Dissektoren

Dissectors  
Disecadores  
Dissecteurs  
Dissettori

# Knochenchirurgie

Bone Surgery  
Cirugía ósea  
Chirurgie osseuse  
Chirurgia ossea

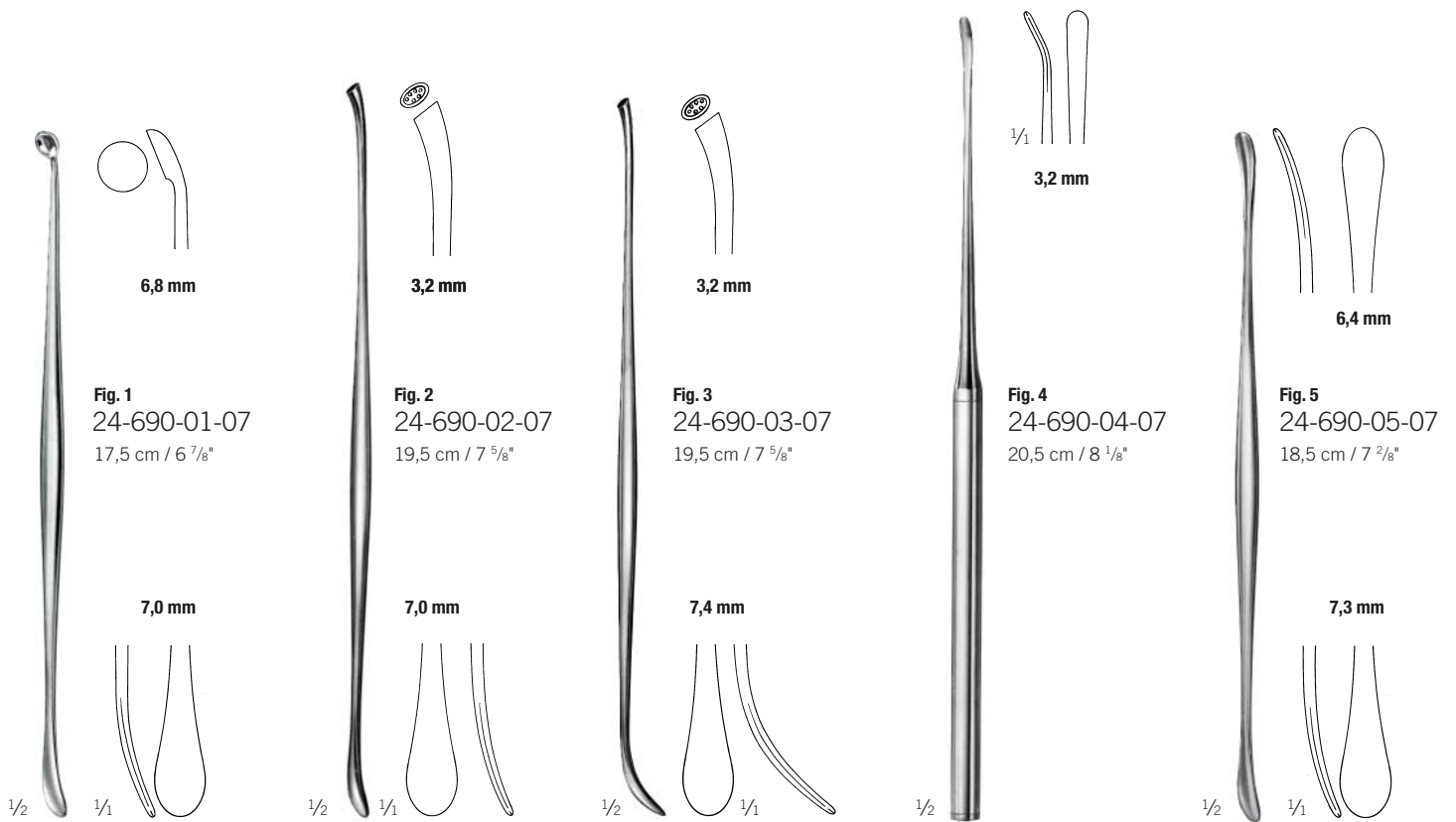
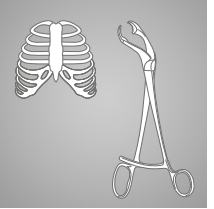

Penfield  
24-690-01-07 -  
24-690-05-07



HF-Chirurgie  
HF Surgery  
Cirugía AF  
Chirurgie HF  
Chirurgia AF

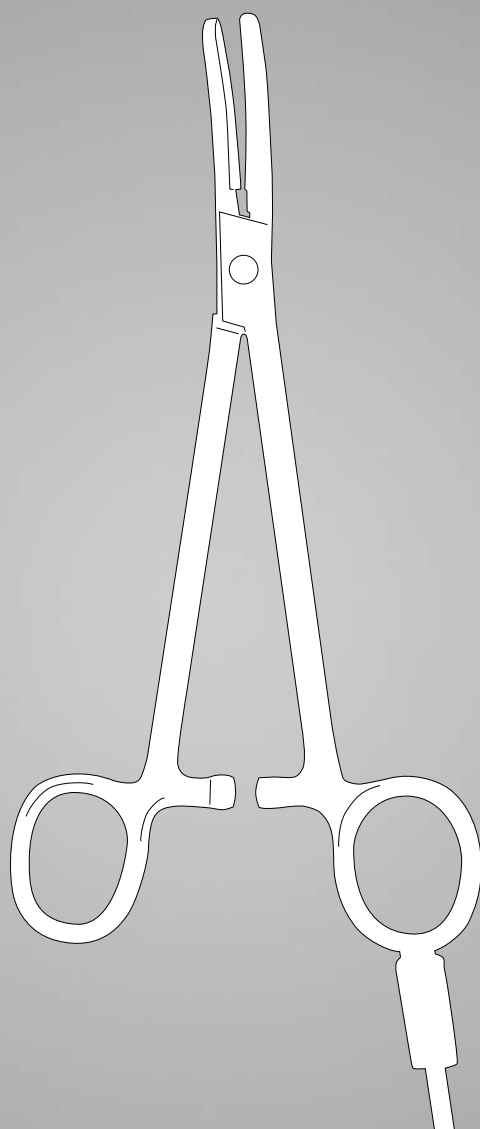

## Bipolare Pinzetten, nonStick red

Bipolar forceps, nonStick red  
Pinzas bipolares, nonStick red  
Pincers bipolaires, nonStick red  
Pinze bipolari, nonStick red

**nonStick** red

max. 500 V<sub>p</sub>

revolutionary  
ergonomic  
design



1/1



1/1

Bipolare Pinzetten, gewinkelt  
Bipolar forceps, angled  
Pinzas bipolares, acodadas  
Pincers bipolaires, coudées  
Pinze bipolari, piegate

Standard

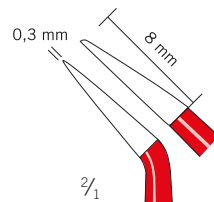

Standard

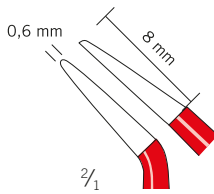

Standard

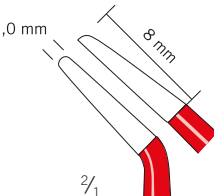

Standard

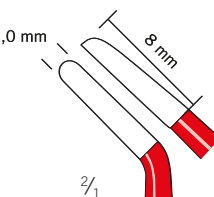

Spitzenbreite Tip width Ancho de la punta Largeur des pointes Larghezza delle punte	Länge Length Longitud Longueur Lunghezza	Artikel-Nr. Item No. N.º referencia Référence Codice articolo
---	--	---

**spitz/pointed/puntiaguda/pointue/acuta**

0,3 mm	12 cm/4 3/4"	80-983-12-04
0,3 mm	17 cm/6 1/4"	80-983-17-04

**stumpf/blunt/roma/mousse/smuusa**

0,6 mm	12 cm/4 3/4"	80-985-12-04
0,6 mm	17 cm/6 1/4"	80-985-17-04
0,6 mm	20 cm/8"	80-985-20-04

**stumpf/blunt/roma/mousse/smuusa**

1,0 mm	12 cm/4 3/4"	80-987-12-04
1,0 mm	17 cm/6 1/4"	80-987-17-04
1,0 mm	20 cm/8"	80-987-20-04
1,0 mm	23 cm/9"	80-987-23-04

**stumpf/blunt/roma/mousse/smuusa**

2,0 mm	17 cm/6 1/4"	80-989-17-04
2,0 mm	20 cm/8"	80-989-20-04
2,0 mm	23 cm/9"	80-989-23-04
2,0 mm	25 cm/9 3/4"	80-989-25-04
2,0 mm	28 cm/11"	80-989-28-04
2,0 mm	30 cm/11 3/4"	80-989-30-04

80-983-12-04  
12 cm/4 3/4"  
spitz, 0,3 mm  
pointed, 0,3 mm  
puntiaguda, 0,3 mm  
pointue, 0,3 mm  
acuta, 0,3 mm

Beispielabbildung  
Example illustration  
Ilustración a modo de ejemplo  
Illustration à titre d'exemple  
Figura di esempio

KLS Martin **nonStick** red –

die bipolaren Pinzetten von KLS Martin mit ANTIHAFTEFFEKT und revolutionärer Ergonomie  
the bipolar forceps from KLS Martin – with nonStick effect and a revolutionary ergonomic design  
las pinzas bipolares de KLS Martin con efecto ANTIADHERENTE y ergonomía revolucionaria  
les pincers bipolaires de KLS Martin à effet ANTI-ADHÉSIF et ergonomie révolutionnaire  
le pinze bipolari di KLS Martin con effetto ANTIADERENTE ed ergonomía rivoluzionaria

## Bipolare Pinzetten, nonStick red

Bipolar forceps, nonStick red  
Pinzas bipolares, nonStick red  
Pincers bipolaires, nonStick red  
Pinze bipolari, nonStick red

## HF-Chirurgie

HF Surgery  
Cirugía AF  
Chirurgie HF  
Chirurgia AF



max. 500 V<sub>p</sub>



1/1

Beispielabbildung  
Example illustration  
Ilustración a modo de ejemplo  
Illustration à titre d'exemple  
Figura di esempio

revolutionary  
ergonomic  
design

Bipolare Pinzetten, bajonettförmig  
Bipolar forceps, bayonet-shaped  
Pinzas bipolares, bayoneta  
Pincers bipolaires, à baïonnette  
Pinze bipolari, baionetta

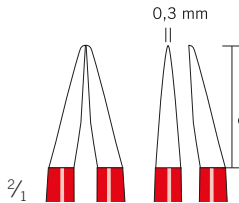
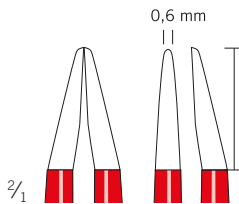
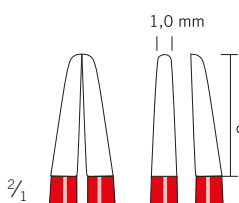
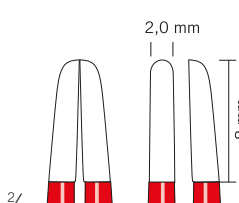
	Spitzenbreite Tip width Ancho de la punta Largeur des pointes Larghezza delle punte	Länge Length Longitud Longueur Lunghezza	Artikel-Nr. Item No. N.º referencia Référence Codice articolo
<b>marSIGHT</b> 	<b>spitz/pointed/puntiaguda/pointue/acuta</b>		
	0,3 mm	17 cm/6 1/4"	80-990-17-04
	0,3 mm	20 cm/8"	80-990-20-04
	0,3 mm	23 cm/9"	80-990-23-04
0,3 mm	25 cm/9 3/4"	80-990-25-04	
<b>marSIGHT</b> 	<b>stumpf/blunt/roma/mousse/smuša</b>		
	0,6 mm	17 cm/6 1/4"	80-991-17-04
	0,6 mm	20 cm/8"	80-991-20-04
	0,6 mm	23 cm/9"	80-991-23-04
0,6 mm	25 cm/9 3/4"	80-991-25-04	
<b>Standard</b> 	<b>stumpf/blunt/roma/mousse/smuša</b>		
	1,0 mm	17 cm/6 1/4"	80-992-17-04
	1,0 mm	20 cm/8"	80-992-20-04
	1,0 mm	23 cm/9"	80-992-23-04
1,0 mm	25 cm/9 3/4"	80-992-25-04	
<b>Standard</b> 	<b>stumpf/blunt/roma/mousse/smuša</b>		
	2,0 mm	17 cm/6 1/4"	80-993-17-04
	2,0 mm	20 cm/8"	80-993-20-04
	2,0 mm	23 cm/9"	80-993-23-04
2,0 mm	25 cm/9 3/4"	80-993-25-04	



## Bipolare Pinzetten, nonStick red

Bipolar forceps, nonStick red  
Pinzas bipolares, nonStick red  
Pincès bipolaires, nonStick red  
Pinze bipolari, nonStick red

**nonStick** red

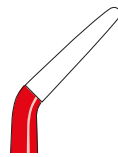

nach oben gewinkelt  
upward-bent  
acodada hacia arriba  
coudée vers le haut  
piegata in alto

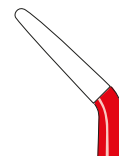

nach unten gewinkelt  
downward-bent  
acodada hacia abajo  
coudée vers le bas  
piegata in basso

**Bipolare Pinzetten, bajonettförmig, gewinkelt**  
**Bipolar forceps, bayonet-shaped, angled**  
**Pinzas bipolares, bayoneta, acodadas**  
**Pincès bipolaires, à baïonnette, coudées**  
**Pinze bipolari, baionetta, piegate**

	Spitzenbreite Tip width Ancho de la punta Largeur des pointes Larghezza delle punte	Länge Length Longitud Longueur Lunghezza	Artikel-Nr. Item No. N.º referencia Référence Codice articolo
<b>Standard</b> 	<b>stumpf/blunt/roma/mousse/smussa</b>		
	0,6 mm	23 cm/9"	80-997-23-04
<b>Standard</b> 	<b>stumpf/blunt/roma/mousse/smussa</b>		
	0,6 mm	25 cm/9 3/4"	80-997-25-04
<b>Standard</b> 	<b>stumpf/blunt/roma/mousse/smussa</b>		
	1,0 mm	20 cm/8"	80-994-20-04
	1,0 mm	23 cm/9"	80-994-23-04
<b>Standard</b> 	<b>stumpf/blunt/roma/mousse/smussa</b>		
	1,0 mm	25 cm/9 3/4"	80-994-25-04
<b>Standard</b> 	<b>stumpf/blunt/roma/mousse/smussa</b>		
	1,0 mm	20 cm/8"	80-995-20-04
	1,0 mm	23 cm/9"	80-995-23-04
<b>Standard</b> 	<b>stumpf/blunt/roma/mousse/smussa</b>		
	1,0 mm	25 cm/9 3/4"	80-995-25-04

1/1

Beispielabbildung  
Example illustration  
Ilustración a modo de ejemplo  
Illustration à titre d'exemple  
Figura di esempio

KLS Martin **nonStick** red –

die bipolaren Pinzetten von KLS Martin mit ANTIHAFTEFFEKT und revolutionärer Ergonomie  
the bipolar forceps from KLS Martin – with nonStick effect and a revolutionary ergonomic design  
las pinzas bipolares de KLS Martin con efecto ANTIADHERENTE y ergonomía revolucionaria  
les pincès bipolaires de KLS Martin à effet ANTI-ADHÉSIF et ergonomie révolutionnaire  
le pinze bipolari di KLS Martin con effetto ANTIADERENTE ed ergonomia rivoluzionaria

## Bipolare Pinzetten, nonStick red, gebogen

Bipolar forceps, nonStick red, curved

Pinzas bipolares, nonStick red, acodadas

Pincès bipolaires, nonStick red, courbes

Pinze bipolari, nonStick red, curve

## HF-Chirurgie

HF Surgery

Cirurgia AF

Chirurgie HF

Chirurgia AF



max. 500 V<sub>p</sub>



80-998-23-04  
23 cm/9"

80-999-23-04  
23 cm/9"

80-999-24-04  
23 cm/9"



Weitere Informationen zu unseren KLS-Martin-nonStick-red-Pinzetten entnehmen Sie bitte der separaten Broschüre.

For further information on our KLS Martin nonStick red range, please refer to our separate product brochure.

Encontrará informaciones adicionales sobre nuestras pinzas KLS Martin nonStick red en el folleto individual.

Vous trouverez des informations supplémentaires sur les pinces nonStick red de KLS Martin dans la brochure.

Per ulteriori informazioni sulle nostre pinze KLS Martin nonStick red vedasi il prospetto separato.

## Bipolare Pinzetten, nonStick flush

Bipolar forceps, nonStick flush  
Pinzas bipolares, nonStick flush  
Pincers bipolaires, nonStick flush  
Pinze bipolari, nonStick flush

**nonStick** flush



max. 500 V<sub>p</sub>

**Bipolare Pinzetten, bajonettförmig, mit einseitiger Spülung**  
Bipolar forceps, bayonet-shaped, with irrigation on one side  
Pinzas bipolares, bayoneta, con función de enjuague unilateral  
Pincers bipolaires, à baïonnette, avec irrigation unilatérale  
Pinze bipolari, a baionetta, con irrigazione unilaterale:

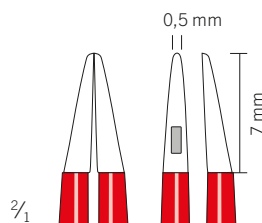

Spitzenbreite Tip width Ancho de la punta Largeur des pointes Larghezza delle punte	Länge Length Longitud Longueur Lunghezza	Artikel-Nr. Item No. N.º referencia Référence Codice articolo
---	--	---

**stumpf/blunt/roma/mousse/smussa**

0,5 x 7 mm	20 cm/8"	80-981-01-04
0,5 x 7 mm	23 cm/9"	80-981-03-04

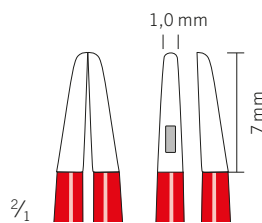

**stumpf/blunt/roma/mousse/smussa**

1,0 x 7 mm	20 cm/8"	80-981-02-04
1,0 x 7 mm	23 cm/9"	80-981-04-04



Zubehör  
Accessories  
Accesorios  
Accessoires  
Accessori

80-981-07-04

Set Reinigungsbürsten, 5 Stück  
Im Lieferumfang der Pinzetten sind bereits Reinigungsbürsten enthalten.

Cleaning brush set, 5 qty.  
Cleaning brushes are included in delivery with the forceps.

Juego de cepillos de limpieza, 5 unidades  
Las prestaciones del suministro de la pinza ya incluyen cepillos de limpieza.

Set de brosses de nettoyage, 5 pièces  
Plusieurs brosses de nettoyage sont d'ores et déjà comprises dans l'étendue de livraison des pincers.

Set di spazzole di pulitura, 5 pezzi  
Nella fornitura sono già comprese le spazzole di pulitura.



Weitere Informationen entnehmen Sie bitte der separaten Broschüre.

For further information please refer to our separate product brochure.

Encontrará informaciones adicionales en el folleto individual.

Vous trouverez des informations supplémentaires dans la brochure.

Per ulteriori informazioni vedasi il prospetto separato.

1/1

Beispielabbildung  
Example illustration  
Ilustración a modo de ejemplo  
Illustration à titre d'exemple  
Figura di esempio

## Anschlusskabel für bipolare Pinzetten

Connection cables for bipolar forceps

Cables de conexión para pinzas bipolares

Câbles de raccordement pour pinces bipolaires

Cavi di connessione per pinze bipolari

## HF-Chirurgie





HF Surgery

Cirurgía AF

Chirurgie HF

Chirurgia AF



<p>Geräte Units Equipos Appareils Apparecchi</p>	<p>Instrumente Instruments Instrumentos Instruments Strumenti</p> <p>Europäischer Flachstecker European flat plug Enchufe plano para Europa Fiche plate européenne Spina piatta Europea</p> <p><b>max. 850 V<sub>p</sub></b></p> 
<p>KLS Martin Berchtold Aesculap</p> 	<p>80-291-40-04 4 m/13 ft.</p>
<p>maxium® „e“ Erbe ICC Erbe ACC Erbe VIO</p> 	<p>80-286-40-04 4 m/13 ft.</p>
<p>maxium® „i“ maxium® „e“ ME MB 2 „i“ ME MB 3 „i“ Valleylab</p> 	<p>80-293-40-04 4 m/13 ft.</p>



mit abgewinkeltem Stecker  
with angled plug  
con clavija acodada  
avec fiche coudé  
con spine piegata

## Bipolare Scheren

Bipolar scissors  
Tijeras bipolares  
Ciseaux bipolaires  
Forbici bipolari

marCut®

### Super Slim Line

Superschlanke Version

Super slim model

Versión super delgada

Version super mince

Versione extra snella

max. 300 V<sub>p</sub>



80-572-13-04  
marCut® SSL  
13 cm / 5 1/8"

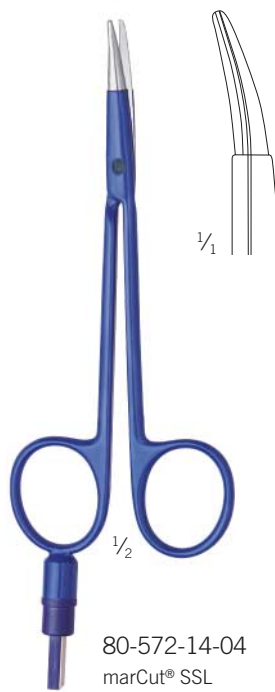

80-572-14-04  
marCut® SSL  
14 cm / 5 5/8"



80-572-17-04  
marCut® SSL  
17 cm / 6 3/8"



80-570-00-04

Protector für die Aufbereitung. Wir empfehlen die Verwendung des Protectors für die Aufbereitung der Schere.

Protector for instrument processing. We recommend using the protector for processing the scissors.

Protector para el tratamiento. Recomendamos la utilización del protector para el tratamiento de las tijeras.

Protecteur pour la préparation. Nous recommandons l'utilisation du protecteur pour la préparation des ciseaux.

Protettore per il trattamento. Si consiglia l'uso del protettore per il trattamento delle forbici.



Weitere Informationen finden Sie im separaten Prospekt marCut®.

For further information, please refer to separate marCut® brochure.

Éncontrará informaciones adicionales en el folleto individual marCut®.

Vous trouverez des informations supplémentaires dans la brochure marCut®.

Per ulteriori informazioni vedasi il prospetto separato marCut®.

# Anschlusskabel für bipolare Scheren

Connection cables for bipolar scissors  
 Cables de conexión para tijeras bipolares  
 Câbles de raccordement pour ciseaux bipolaires  
 Cavi di connessione per forbici bipolari

## HF-Chirurgie

HF Surgery  
 Cirugía AF  
 Chirurgie HF  
 Chirurgia AF



Geräte Units Equipos Appareils Apparecchi	Instrumente Instruments Instrumentos Instruments Strumenti	Europäischer Flachstecker, rund European flat plug, round Enchufe plano para Europa, redondo Fiche plate européenne, rond Spina piatta Europea, rotondo	
		max. 600 V <sub>p</sub>	max. 850 V <sub>p</sub>
KLS Martin Berchtold Aesculap		80-287-33-04 3 m/10 ft.	80-291-40-04 4 m/13 ft.
		80-287-53-04 5 m/16 ft.	
maxium® „e“ Erbe ICC Erbe ACC Erbe VIO		80-286-30-04 3 m/10 ft.	80-286-40-04 4 m/13 ft.
		80-286-50-04 5 m/16 ft.	
maxium® „i“ maxium® „e“ ME MB 2 „i“ ME MB 3 „i“ Valleylab		80-287-89-04 3 m/10 ft.	80-293-40-04 4 m/13 ft.
		80-287-90-04 5 m/16 ft.	
Codman		80-287-72-04 5 m/16 ft.	



mit geradem Stecker  
 with straight plug  
 con clavija recta  
 avec fiche droite  
 con spina diritta



mit abgewinkeltem Stecker  
 with angled plug  
 con clavija acodada  
 avec fiche coudé  
 con spine piegata

# Übersicht der elektrochirurgischen Geräte

Overview of electrosurgical units

Resumen de aparatos electroquirúrgicos

Résumé des bistouris électrochirurgicaux

Elenco degli apparecchi elettrochirurgici

## maXium®



80-042-00-04

maXium® m

(100-240 V)

80-042-02-04

maXium® i

(100-240 V)

80-042-04-04

maXium® e

(100-240 V)

80-093-00-04

maxium®

Option bipolare Resektion  
"Bipolar Resection" option  
Opción "Resección bipolar"  
Option «Résection bipolaire»  
Opzione "Resezione bipolare"

80-093-01-04

maxium®

Option Einbindung in OR 1-Neo/Karl Storz  
Option "Integration into Karl Storz OR1 NEO system"  
Opción de integración en el sistema OR1 NEO/Karl Storz  
Option «Intégration dans le système OR1 NEO/Karl Storz»  
Opzione "Integrazione nel sistema OR1 NEO/Karl Storz"

80-044-00-04

maxium® Beamer

Nur zur Verwendung mit dem maxium®-Generator  
For use only with the maxium® generator  
Utilícese sólo con generador maxium®  
A n'utiliser qu'avec générateur maxium®  
Solo per l'utilizzo con generatore maxium®



Weitere Informationen finden Sie im separaten Prospekt maxium®.

For further information, please refer to separate maxium® brochure.

Éncontrará informaciones adicionales en el folleto individual maxium®.

Vous trouverez des informations supplémentaires dans la brochure maxium®.

Per ulteriori informazioni vedasi il prospetto separato maxium®.







## maXium® smart C



**reddot award 2016**  
winner



**Focus Open 2016**  
Special Mention



80-043-00-04  
maXium® smart C **m**  
(100-240 V)

80-043-01-04  
maXium® smart C **i**  
(100-240 V)

80-043-02-04  
maXium® smart C **e**  
(100-240 V)

80-094-00-04  
maXium® smart C  
Option SWAP-Mode  
Option SWAP mode  
Opción modo SWAP  
Option mode SWAP  
Opzione modo SWAP

80-094-01-04  
maXium® smart C  
Option Duo-Prep, Duo-Spray  
Option Duo-Prep, Duo-Spray  
Opción Duo-Prep, Duo-Spray  
Option Duo-Prep, Duo-Spray  
Opzione Duo-Prep, Duo-Spray

80-094-02-04  
maXium® smart C  
Option Neptun  
Option Neptun  
Opción Neptun  
Option Neptun  
Opzione Neptun



Weitere Informationen finden Sie im separaten Prospekt maXium® smart C.

For further information, please refer to separate maXium® smart C brochure.

Éncontrará informaciones adicionales en el folleto individual maXium® smart C.

Vous trouverez des informations supplémentaires dans la brochure maXium® smart C.

Per ulteriori informazioni vedasi il prospetto separato maXium® smart C.

## ME 102



Weitere Informationen finden Sie im separaten Prospekt ME 102.

For further information, please refer to separate ME 102 brochure.

Éncontrará informaciones adicionales en el folleto individual ME 102 .

Vous trouverez des informations supplémentaires dans la brochure ME 102 .

Per ulteriori informazioni vedasi il prospetto separato ME 102 .

80-010-02-04  
(220-240 V)

80-010-02-12  
(100-127 V)



## Laser-Systeme

Laser Systems  
Sistemas láser  
Systèmes au laser  
Sistemi laser

**Laser-assistierte Neurochirurgie** – höchste Präzision bei maximaler Gewebeschonung.

**Laser assisted Neurosurgery** – the new level in precision and tissue protection.

**Neurocirugía asistida por láser** – máxima precisión y conservación del tejido.

**Neurochirurgie assistée au laser** – une extrême précision alliée à une préservation maximale des tissus.

**Neurochirurgia Laser-assistita** – elevata precisione e massima protezione dei tessuti.

Diodenlaser diomax®

Diode laser diomax®

Láser de diodo diomax®

Laser diode diomax®

Laser a diodi diomax®

CO<sub>2</sub>-Laser MCO 25plus

CO<sub>2</sub> Laser MCO 25plus

Láser CO<sub>2</sub> MCO 25plus

Laser CO<sub>2</sub> MCO 25plus

Laser CO<sub>2</sub> MCO 25plus



Weitere Informationen finden Sie im separaten Prospekt diomax®.

For further information, please refer to separate diomax® brochure.

Éncontrará informaciones adicionales en el folleto individual diomax®.

Vous trouverez des informations supplémentaires dans la brochure diomax®.

Per ulteriori informazioni vedasi il prospetto separato diomax®.



Weitere Informationen finden Sie im separaten Prospekt CO<sub>2</sub>-Laser MCO 25plus.

For further information, please refer to separate CO<sub>2</sub> laser MCO 25plus brochure.

Éncontrará informaciones adicionales en el folleto individual láser CO<sub>2</sub> MCO 25plus.

Vous trouverez des informations supplémentaires dans la brochure laser CO<sub>2</sub> MCO 25plus.

Per ulteriori informazioni vedasi il prospetto separato laser CO<sub>2</sub> MCO 25plus.

Mund-, Kiefer- und Gesichtschirurgie  
Oral Maxillo-facial Surgery  
Cirugía oral y maxilofacial  
Chirurgie buccale et maxillo-faciale  
Chirurgia maxillo-facciale

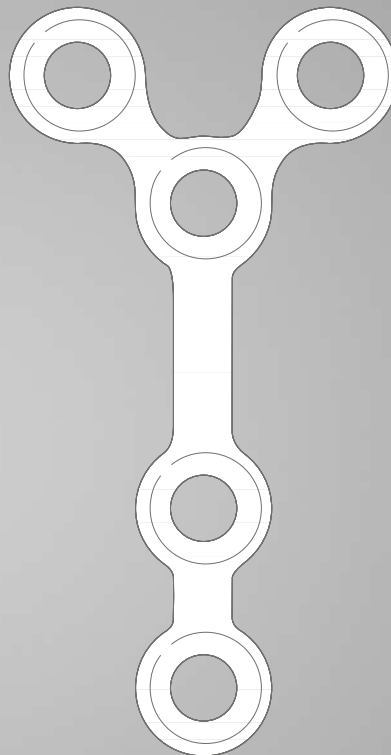
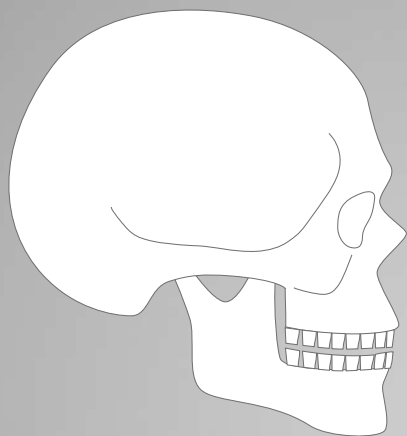

## Spezial-Produkte

Special Products  
Productos especiales  
Produits spéciaux  
Prodotti speciali

Informationen zu den KLS-Martin-Osteosynthese-Systemen entnehmen Sie bitte den separaten Broschüren:

- IPS Implants® Cranium
- Low Profile Neuro System
- SAM – Standard Approach Mesh
- Steriles Neuro Flap Fix Kit

Please refer to the separate brochures for information about KLS Martin osteosynthesis systems:

- IPS Implants® Cranium
- Low Profile Neuro System
- SAM – Standard Approach Mesh
- Sterile Neuro Flap Fix Kit

Encontrará información sobre los sistemas de osteosíntesis de KLS Martin en los folletos específicos:

- IPS Implants® Cranium
- Sistema Low Profile Neuro
- SAM – Standard Approach Mesh
- Neuro Flap Fix Kit estéril

Veuillez vous reporter aux brochures séparées pour obtenir des informations détaillées à propos ostéosynthèse KLS Martin:

- IPS Implants® Cranium
- Système Low Profile Neuro
- SAM – Standard Approach Mesh
- Neuro Flap Fix Kit stérile

Per informazioni sui sistemi osteosintesi di KLS Martin, consultare le brochure separate:

- IPS Implants® Cranium
- Sistema Low Profile Neuro
- SAM – Standard Approach Mesh
- Kit sterile Flap Fix per neurochirurgia

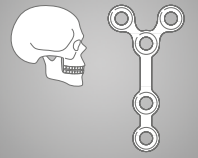

**KLS martin GROUP**



**Sterile Neuro Flap Fix Kit**  
 For the simple and stable fixation of cranial bone flaps and fractures

These 2 hole low profile screws with the self-drilling, non-Crush™ screws inserted into a pre-drill or other a variety of substrates such as the patient's skull as to the case.

**Proven application – new outfit!**

- Quick and simple
- Higher quality
- Superior fixation
- Best coverage in case

**And because it is a whole kit:**

- Quick and easy to remove and modify
- Higher quality
- Superior fixation
- Complete Fixation
- With sterile for patient safety, 100% patient protection

**The sterile Neuro Flap Fix Kit (Kit No. 20-302-10-71) includes:**

- 2x 2 hole low profile screws
- 1x 10 mm non-Crush™ screws, 4.0 mm long, self-drilling

[www.klsmartin.com](http://www.klsmartin.com)

**KLS martin GROUP**



**SAM**  
 Standard Approach Mesh  
 Pre-contoured titanium mesh implants

[www.klsmartin.com](http://www.klsmartin.com)

**KLS martin GROUP**



**Low Profile Neuro System**  
 1.5-mm Neuro Plating System

[www.klsmartin.com](http://www.klsmartin.com)

**KLS martin GROUP**



**IPS Implants®**  
 Cranium



[www.klsmartin.com](http://www.klsmartin.com)

## Spezial-Produkte

Special Products

Productos especiales

Produits spéciaux

Prodotti speciali

Informationen zu den Distraktoren von KLS Martin entnehmen Sie bitte der separaten Broschüre:

- Cranial Distraction (Kawamoto, Posterior Cranial Vault Distractor)

Please refer to the separate brochure for information about KLS Martin distractors:

- Cranial Distraction (Kawamoto, Posterior Cranial Vault Distractor)

Encontrará información sobre los distractores de KLS Martin en el folleto específico:

- Cranial Distraction (Kawamoto, Posterior Cranial Vault Distractor)

Veuillez vous reporter à la brochure séparée pour obtenir des informations détaillées à propos des distracteurs de KLS Martin:

- Cranial Distraction (Kawamoto, Posterior Cranial Vault Distractor)

Per informazioni sui distrattori di KLS Martin, consultare la brochure separata:

- Cranial Distraction (Kawamoto, Posterior Cranial Vault Distractor)

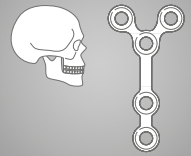

## **SonicWeld Rx®** – Die Revolution der Osteosynthese

KLS Martin hat mit SonicWeld Rx® ein revolutionäres System für die Kieferknochenaugmentation entwickelt. Mit modernster Ultraschalltechnik, kombiniert mit resorbierbaren Implantaten, wird die Metallentfernung überflüssig. Dank des völlig neuen Verschweißungsprozesses verankert sich das resorbierbare Material tief in der Knochenstruktur und erzeugt eine bislang ungekannte Primärstabilität. In der präprothetischen Augmentation eignet sich das System für resorbierbare Membranfixierungen (Guided Bone Regeneration), Auflagerungen (Onlay Grafts) und Schalungen (Split Grafts).



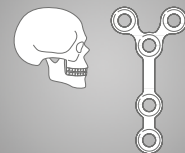

EN

## Sonic Weld Rx® – The revolution in osteosynthesis

With SonicWeld Rx®, KLS Martin offers a revolutionary system for jaw bone augmentation. Highly advanced ultrasound technology combined with resorbable implants makes the metal removal redundant. Thanks to the completely novel welding technique, the bioabsorbable material penetrates deeply into the bone structure to provide a level of primary stability never seen before. In preprosthetic augmentation, this system can be used for resorbable membrane fixation (guided bone regeneration), appositions (onlay grafts) procedures based on the innovative shell technique (split grafts).

ES

## Sonic Weld Rx® – La revolución de la osteosíntesis

Con SonicWeld Rx®, KLS Martin ha diseñado un sistema revolucionario para el aumento del hueso maxilar. La más avanzada tecnología de ultrasonidos, combinada con implantes reabsorbibles, hace innecesaria la eliminación de metales. Gracias al innovador proceso de soldadura, el material reabsorbible se ancla profundamente en la estructura ósea y proporciona una estabilidad primaria sin precedentes. En el aumento preprotésico, este sistema es apropiado para fijaciones de membranas reabsorbibles (guided bone regeneration - regeneración ósea guiada), aposiciones (onlay grafts) y la técnica de valva (split grafts).

FR

## Sonic Weld Rx® – La révolution de l'ostéosynthèse

KLS Martin a mis au point, avec SonicWeld Rx®, un système révolutionnaire pour l'augmentation de la masse osseuse de la mâchoire. Avec une technique à ultrasons ultrasonore, associée à des implants résorbables, le retrait du métal devient superflu. Grâce au tout nouveau processus de soudage, le matériau résorbable s'ancre en profondeur dans la structure osseuse et génère une stabilité primaire jusqu'à présent inconnue. Dans le cadre de l'augmentation pré-prothétique, le système est adapté pour les régénérations osseuses guidées (guided bone regeneration), les greffes osseuses (onlay grafts) et les greffes fendues (split grafts).

IT

## Sonic Weld Rx® – La rivoluzione dell'osteosintesi

KLS Martin ha sviluppato con SonicWeld Rx® un sistema rivoluzionario per l'aumento dell'osso mascellare. La più moderna tecnologia ad ultrasuoni, abbinata a impianti riassorbibili, rende superflua la rimozione del metallo. Grazie al processo di saldatura completamente rinnovato, il materiale riassorbibile si ancora profondamente alla struttura ossea raggiungendo una stabilità primaria finora mai vista. Nella fase di aumento pre-protetica, questo sistema è indicato per fissaggi riassorbibili di membrane (guided bone regeneration), apposizioni (onlay grafts) e gusci (split grafts).





---

Nummern-Index  
Index of order numbers  
Índice de números de referencia  
Index numérique des références de commande  
Elenco dei codici

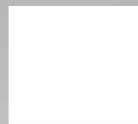

# Nummern-Index

Index of order numbers

Índice de números de referencia

Index numérique des références de commande

Elenco dei codici

## 10

10-100-04-07.....	78
10-104-41-07.....	78
10-130-03-07.....	78
10-133-31-07.....	78
10-135-01-07.....	79
10-137-07-07.....	79
10-155-10-04.....	80
10-155-11-04.....	80
10-155-12-04.....	80
10-155-13-04.....	80
10-155-15-04.....	80
10-155-18-04.....	80
10-155-20-04.....	80
10-155-21-04.....	80
10-155-22-04.....	80
10-155-23-04.....	80
10-156-12-04.....	80
10-156-15-04.....	80
10-160-01-07.....	79
10-199-00-01.....	80
10-285-18-04.....	81
10-285-21-04.....	81
10-285-22-04.....	81
10-295-10-04.....	82
10-295-11-04.....	82
10-295-12-04.....	82
10-295-13-04.....	82
10-295-22-04.....	82
10-296-12-04.....	82
10-296-15-04.....	82

## 11

11-100-11-07.....	84
11-100-13-07.....	84
11-100-14-07.....	84
11-100-16-07.....	84
11-100-18-07.....	84
11-100-20-07.....	84
11-102-11-07.....	85
11-102-13-07.....	85
11-102-14-07.....	85
11-102-16-07.....	85
11-102-18-07.....	85
11-102-20-07.....	85
11-104-11-07.....	86
11-104-13-07.....	86
11-104-14-07.....	86
11-104-16-07.....	86
11-105-11-07.....	87
11-105-13-07.....	87
11-105-14-07.....	87
11-105-16-07.....	87
11-105-18-07.....	87
11-105-20-07.....	87
11-107-11-07.....	88
11-107-13-07.....	88
11-107-14-07.....	88
11-107-18-07.....	88
11-107-20-07.....	88
11-109-11-07.....	89
11-109-13-07.....	89
11-109-14-07.....	89
11-109-16-07.....	89
11-136-14-07.....	90
11-140-14-07.....	90
11-170-14-07.....	91
11-170-17-07.....	91
11-170-23-07.....	91
11-171-14-07.....	92
11-171-17-07.....	92
11-171-23-07.....	92
11-180-17-07.....	93
11-181-15-07.....	94
11-181-17-07.....	94
11-184-19-07.....	93
11-185-19-07.....	94
11-185-21-07.....	94
11-190-17-07.....	95
11-191-17-07.....	95

11-226-16-07.....	96
11-227-16-07.....	97
11-248-11-07.....	98
11-249-11-07.....	99
11-250-14-07.....	98
11-252-14-07.....	100
11-254-14-07.....	100
11-255-14-07.....	99
11-257-14-07.....	100
11-259-14-07.....	100
11-264-15-07.....	101
11-265-15-07.....	102
11-280-18-07.....	101
11-280-20-07.....	101
11-280-23-07.....	101
11-280-25-07.....	101
11-280-28-07.....	101
11-280-30-07.....	101
11-284-18-07.....	104
11-284-20-07.....	104
11-285-18-07.....	102
11-285-20-07.....	102
11-285-23-07.....	102
11-285-25-07.....	102
11-285-28-07.....	102
11-285-30-07.....	102
11-298-14-07.....	104
11-299-14-07.....	104
11-300-15-07.....	104
11-301-15-07.....	104
11-302-15-07.....	104
11-310-16-07.....	105
11-311-16-07.....	106
11-313-18-07.....	108
11-313-21-07.....	108
11-313-24-07.....	108
11-314-18-07.....	108
11-314-21-07.....	108
11-315-17-07.....	109
11-315-20-07.....	109
11-316-17-07.....	109
11-316-20-07.....	109
11-317-11-07.....	110
11-317-14-07.....	110
11-320-10-07.....	111
11-321-10-07.....	112
11-324-16-07.....	113
11-325-16-07.....	113
11-326-14-07.....	114
11-327-14-07.....	115
11-328-14-07.....	116
11-329-14-07.....	117
11-329-18-07.....	117
11-329-20-07.....	117
11-330-18-07.....	114
11-330-20-07.....	114
11-330-23-07.....	114
11-331-18-07.....	115
11-331-20-07.....	115
11-331-23-07.....	115
11-335-18-07.....	118
11-335-20-07.....	118
11-335-23-07.....	118
11-350-14-07.....	119
11-351-14-07.....	119
11-358-13-07.....	120
11-364-14-07.....	121
11-364-15-07.....	121
11-364-18-07.....	121
11-365-14-07.....	122
11-365-15-07.....	122
11-365-18-07.....	122
11-367-14-07.....	123
11-369-14-07.....	123
11-370-01-07.....	38
11-370-02-07.....	38
11-371-01-07.....	38
11-371-02-07.....	38
11-371-03-07.....	38
11-371-04-07.....	38

11-371-05-07.....	38
11-371-06-07.....	38
11-371-07-07.....	38
11-371-08-07.....	38
11-384-25-07.....	39
11-384-45-07.....	39
11-384-60-07.....	39
11-384-90-07.....	39
11-385-00-07.....	39
11-400-25-07.....	39
11-400-45-07.....	39
11-400-60-07.....	39
11-400-90-07.....	39
11-401-00-07.....	39
11-412-25-07.....	39
11-412-45-07.....	39
11-412-60-07.....	39
11-412-90-07.....	39
11-413-00-07.....	39
11-436-25-07.....	39
11-436-45-07.....	39
11-436-60-07.....	39
11-436-90-07.....	39
11-437-00-07.....	39
11-445-22-07.....	123
11-446-22-07.....	123
11-455-17-07.....	123
11-459-17-07.....	124
11-475-23-07.....	125
11-630-11-07.....	126
11-631-11-07.....	127
11-650-14-07.....	85
11-651-14-07.....	88
11-652-14-07.....	91
11-652-17-07.....	91
11-652-23-07.....	91
11-653-14-07.....	92
11-653-17-07.....	92
11-653-23-07.....	92
11-654-15-07.....	93
11-654-17-07.....	93
11-655-15-07.....	94
11-655-17-07.....	94
11-656-16-07.....	96
11-657-16-07.....	97
11-658-11-07.....	98
11-659-11-07.....	99
11-659-14-07.....	99
11-660-18-07.....	101
11-660-20-07.....	101
11-660-23-07.....	101
11-660-26-07.....	101
11-660-28-07.....	101
11-660-31-07.....	101
11-661-18-07.....	102
11-661-20-07.....	102
11-661-23-07.....	102
11-661-26-07.....	102
11-661-28-07.....	102
11-661-31-07.....	102
11-662-10-07.....	111
11-662-16-07.....	105
11-663-10-07.....	112
11-663-16-07.....	106
11-665-14-07.....	115
11-665-18-07.....	115
11-665-20-07.....	115
11-665-23-07.....	115
11-666-14-07.....	119
11-667-14-07.....	119
11-671-15-07.....	122
11-671-18-07.....	122
11-672-11-07.....	126
11-673-11-07.....	127
11-674-10-07.....	129
11-675-10-07.....	129
11-676-10-07.....	128
11-677-10-07.....	128
11-678-10-07.....	128
11-679-10-07.....	128

11-680-11-07.....	129
11-681-11-07.....	129
11-682-11-07.....	128
11-683-11-07.....	128
11-710-15-07.....	40
11-710-18-07.....	40
11-710-19-07.....	40
11-711-15-07.....	40
11-711-18-07.....	40
11-711-19-07.....	40
11-711-20-07.....	40
11-712-15-07.....	40
11-712-18-07.....	40
11-712-19-07.....	40
11-713-15-07.....	40
11-713-18-07.....	40
11-713-19-07.....	40
11-713-20-07.....	40
11-758-12-07.....	41
11-760-09-07.....	41
11-761-09-07.....	41
11-865-12-07.....	130
11-887-11-07.....	99
11-887-18-07.....	103
11-887-20-07.....	103
11-887-23-07.....	103
11-887-25-07.....	103
11-887-30-07.....	103
11-889-14-07.....	115
11-889-18-07.....	115
11-893-17-07.....	124
11-895-16-07.....	107
11-902-14-07.....	84
11-903-14-07.....	87
11-904-14-07.....	85
11-905-14-07.....	88
11-906-14-07.....	86
11-907-14-07.....	89
11-910-14-07.....	91
11-910-17-07.....	91
11-910-23-07.....	91
11-911-14-07.....	92
11-911-17-07.....	92
11-911-23-07.....	92
11-914-14-07.....	131
11-914-18-07.....	90, 131
11-914-20-07.....	131
11-914-23-07.....	131
11-914-25-07.....	131
11-914-30-07.....	131
11-915-14-07.....	132
11-915-17-07.....	132
11-915-23-07.....	132
11-916-14-07.....	133
11-916-18-07.....	133
11-916-20-07.....	133
11-917-11-07.....	99
11-917-18-07.....	103
11-917-20-07.....	103
11-917-23-07.....	103
11-917-25-07.....	103
11-917-30-07.....	103
11-919-14-07.....	133
11-919-18-07.....	133
11-921-17-07.....	124
11-923-16-07.....	107
11-930-15-07.....	93
11-930-17-07.....	93
11-931-15-07.....	94
11-931-17-07.....	94
11-934-12-07.....	134
11-935-12-07.....	134
11-936-11-07.....	98
11-937-11-07.....	99
11-938-14-07.....	98
11-939-14-07.....	99
11-942-18-07.....	101
11-942-20-07.....	101
11-942-23-07.....	101
11-942-25-07.....	101

11-942-28-07.....	101
11-942-30-07.....	101
11-943-18-07.....	102
11-943-20-07.....	102
11-943-23-07.....	102
11-943-25-07.....	102
11-943-28-07.....	102
11-943-30-07.....	102
11-948-14-07.....	119
11-949-14-07.....	119
11-950-10-07.....	134
11-950-16-07.....	105
11-950-21-07.....	105
11-951-10-07.....	134
11-951-16-07.....	106
11-951-21-07.....	106
11-954-14-07.....	114
11-955-14-07.....	115
11-956-14-07.....	116
11-957-14-07.....	117
11-960-18-07.....	114
11-961-18-07.....	115
11-961-20-07.....	115
11-961-23-07.....	115
11-961-25-07.....	115
11-961-28-07.....	115
11-962-18-07.....	116
11-962-20-07.....	116
11-962-23-07.....	116
11-965-14-07.....	134
11-965-17-07.....	124
11-967-18-07.....	118
11-967-20-07.....	118
11-967-23-07.....	118
11-982-11-07.....	126
11-983-11-07.....	127
11-992-16-07.....	96
11-993-16-07.....	97
11-995-12-07.....	130

## 12

12-100-10-07.....	136
12-100-11-07.....	136
12-100-13-07.....	136
12-100-14-07.....	136
12-100-16-07.....	136
12-100-18-07.....	136
12-100-20-07.....	136
12-100-23-07.....	136
12-100-25-07.....	136
12-100-30-07.....	136
12-120-11-07.....	136
12-120-13-07.....	136
12-120-14-07.....	136
12-120-16-07.....	136
12-120-18-07.....	136
12-120-20-07.....	136
12-120-23-07.....	136
12-120-25-07.....	136
12-120-30-07.....	136
12-122-13-07.....	137
12-126-13-07.....	137
12-126-14-07.....	137
12-132-19-07.....	137
12-134-20-07.....	137
12-168-12-07.....	137
12-168-15-07.....	137
12-170-15-07.....	137
12-172-12-07.....	138
12-172-15-07.....	138
12-186-18-07.....	138
12-187-18-07.....	138
12-192-18-07.....	138
12-192-21-07.....	138
12-192-25-07.....	138
12-192-30-07.....	138
12-238-15-07.....	139
12-240-16-07.....	139
12-240-18-07.....	139
12-242-16-07.....	139

12-242-18-07.....	139
12-244-12-07.....	140
12-246-12-07.....	140
12-246-15-07.....	140
12-250-12-07.....	140
12-250-15-07.....	140
12-252-12-07.....	140
12-252-15-07.....	140
12-254-17-07.....	141
12-255-18-07.....	141
12-256-18-07.....	141
12-258-14-07.....	141
12-258-18-07.....	141
12-258-20-07.....	141
12-258-23-07.....	141
12-258-25-07.....	141
12-301-10-07.....	142
12-301-11-07.....	142
12-301-13-07.....	142
12-301-14-07.....	142
12-301-16-07.....	142
12-301-18-07.....	142
12-301-20-07.....	142
12-301-25-07.....	142
12-301-30-07.....	142
12-302-13-07.....	142
12-302-14-07.....	142
12-302-16-07.....	142
12-302-18-07.....	142
12-302-20-07.....	142
12-303-14-07.....	143
12-303-16-07.....	143
12-303-20-07.....	143
12-304-14-07.....	143
12-304-16-07.....	143
12-321-13-07.....	143
12-321-14-07.....	143
12-321-16-07.....	143
12-321-18-07.....	143
12-321-20-07.....	143
12-323-15-07.....	143
12-367-15-07.....	144
12-367-20-07.....	144
12-368-12-07.....	144
12-368-15-07.....	144
12-370-15-07.....	144
12-372-12-07.....	144
12-372-15-07.....	144
12-386-17-07.....	144
12-387-17-07.....	144
12-392-18-07.....	145
12-392-21-07.....	145
12-392-25-07.....	145
12-400-12-07.....	145
12-404-12-07.....	145
12-404-15-07.....	145
12-406-12-07.....	145
12-406-15-07.....	145
12-552-01-07.....	46
12-552-02-07.....	46
12-552-03-07.....	46
12-552-04-07.....	46
12-552-05-07.....	46
12-552-06-07.....	46
12-552-07-07.....	46
12-552-08-07.....	46
12-552-09-07.....	46
12-552-10-07.....	46
12-552-11-07.....	46
12-552-12-07.....	46
12-553-01-07.....	46
12-553-05-07.....	46
12-553-07-07.....	46
12-553-08-07.....	46
12-553-09-07.....	46
12-560-00-07.....	47
12-560-02-07.....	47
12-560-03-07.....	47
12-560-05-07.....	47
12-560-45-07.....	47
12-561-00-07.....	47
12-561-02-07.....	47
12-561-03-07.....	47
12-561-05-07.....	47
12-561-45-07.....	47
12-562-00-07.....	47
12-562-01-07.....	47
12-562-02-07.....	47
12-562-03-07.....	47
12-562-04-07.....	47
12-562-05-07.....	47
12-563-00-07.....	47
12-563-01-07.....	47
12-563-02-07.....	47
12-563-03-07.....	47
12-563-04-07.....	47
12-563-05-07.....	47
12-564-15-07.....	48
12-564-18-07.....	48
12-565-15-07.....	48
12-565-18-07.....	48
12-566-15-07.....	48
12-566-18-07.....	48
12-566-21-07.....	48
12-567-15-07.....	48
12-567-18-07.....	48
12-567-21-07.....	48
12-574-15-07.....	49
12-574-18-07.....	49
12-574-21-07.....	49
12-576-15-07.....	49
12-576-18-07.....	49
12-576-21-07.....	49
12-578-15-09.....	48
12-578-18-09.....	48
12-579-15-09.....	48
12-579-18-09.....	48
12-580-15-09.....	48
12-580-18-09.....	48
12-580-21-09.....	48
12-581-15-09.....	48
12-581-18-09.....	48
12-581-21-09.....	48
12-586-15-09.....	49
12-586-18-09.....	49
12-586-21-09.....	49
12-588-15-09.....	49
12-588-18-09.....	49
12-588-21-09.....	49
12-589-15-07.....	49
12-589-18-07.....	49
12-589-21-07.....	49
12-590-15-09.....	49
12-590-18-09.....	49
12-590-21-09.....	49
12-591-00-07.....	49
12-591-01-07.....	49
12-591-02-07.....	49
12-591-03-07.....	49
12-591-04-07.....	49
12-591-05-07.....	49
12-592-00-07.....	49
12-592-01-07.....	49
12-592-02-07.....	49
12-592-03-07.....	49
12-592-04-07.....	49
12-592-05-07.....	49
12-774-15-07.....	49
12-774-18-07.....	49
12-774-21-07.....	49
12-776-15-07.....	49
12-776-18-07.....	49
12-776-21-07.....	49
12-786-18-09.....	49
12-786-21-09.....	49
12-787-15-09.....	49
12-787-18-09.....	49
12-787-21-09.....	49
13-010-00-07.....	150
13-050-14-07.....	150
13-051-14-07.....	150
13-052-04-07.....	150
13-052-05-07.....	150
13-053-05-07.....	150
13-054-05-07.....	151
13-055-05-07.....	151
13-056-03-07.....	151
13-058-05-07.....	151
13-059-05-07.....	151
13-062-00-07.....	152
13-062-01-07.....	152
13-062-02-07.....	152
13-102-04-07.....	153
13-102-06-07.....	153
13-102-08-07.....	153
13-102-10-07.....	153
13-104-14-07.....	153
13-106-18-07.....	153
13-303-01-07.....	154
13-303-02-07.....	154
13-304-14-07.....	154
13-305-18-07.....	154
13-310-12-07.....	154
13-310-14-07.....	93, 154
13-311-12-07.....	154
13-311-14-07.....	154
13-312-12-07.....	154
13-312-14-07.....	154
13-313-12-07.....	154
13-313-14-07.....	154
13-316-18-07.....	155
13-316-21-07.....	155
13-317-18-07.....	155
13-317-21-07.....	155
13-318-18-07.....	155
13-318-21-07.....	155
13-319-18-07.....	155
13-319-21-07.....	155
13-324-14-07.....	156
13-325-14-07.....	156
13-330-14-07.....	156
13-331-14-07.....	156
13-334-16-07.....	156
13-335-16-07.....	156
13-340-14-07.....	157
13-341-14-07.....	157
13-342-14-07.....	157
13-343-14-07.....	157
13-346-16-07.....	157
13-347-16-07.....	157
13-355-14-07.....	157
13-357-14-07.....	157
13-374-13-07.....	158
13-374-14-07.....	158
13-374-16-07.....	158
13-375-13-07.....	158
13-375-14-07.....	158
13-375-16-07.....	158
13-384-13-07.....	158
13-384-14-07.....	158
13-384-16-07.....	158
13-385-13-07.....	158
13-385-14-07.....	158
13-385-16-07.....	158
13-410-14-07.....	159
13-410-16-07.....	159
13-410-18-07.....	159
13-410-22-07.....	159
13-410-24-07.....	159
13-410-26-07.....	159
13-410-30-07.....	159
13-411-14-07.....	160
13-411-16-07.....	160
13-411-18-07.....	160
13-411-20-07.....	160
13-411-22-07.....	160
13-411-24-07.....	160
13-411-26-07.....	160
13-411-30-07.....	160
13-414-14-07.....	161
13-414-16-07.....	161
13-414-18-07.....	161
13-414-20-07.....	161
13-414-22-07.....	161
13-414-24-07.....	161
13-414-26-07.....	161
13-414-30-07.....	161
13-415-14-07.....	162
13-415-16-07.....	162
13-415-18-07.....	162
13-415-20-07.....	162
13-415-22-07.....	162
13-415-24-07.....	162
13-415-26-07.....	162
13-415-30-07.....	162
13-419-18-07.....	163
13-421-14-07.....	163
13-421-18-07.....	163
13-443-01-07.....	164
13-443-02-07.....	164
13-443-03-07.....	164
13-443-04-07.....	164
13-443-05-07.....	164
13-443-06-07.....	164
13-443-07-07.....	164
13-447-01-07.....	164
13-447-02-07.....	164
13-447-03-07.....	164
13-447-04-07.....	164
13-447-05-07.....	164
13-447-06-07.....	164
13-447-07-07.....	164
13-451-13-07.....	165
13-451-16-07.....	165
13-451-18-07.....	165
13-451-20-07.....	165
13-451-23-07.....	165
13-451-25-07.....	165
13-451-28-07.....	165
13-453-18-07.....	165
13-453-22-07.....	165
13-453-25-07.....	165
13-453-28-07.....	165
13-915-08-07.....	166
13-915-11-07.....	166
13-915-13-07.....	166
13-915-15-07.....	166
13-924-11-07.....	166
13-924-14-07.....	166
<b>15</b>	
15-066-01-07.....	168
15-066-02-07.....	168
15-074-01-07.....	168
15-074-02-07.....	168
15-074-03-07.....	168
15-074-04-07.....	168
15-075-01-07.....	168
15-075-02-07.....	168
15-075-03-07.....	168
15-075-04-07.....	168
15-091-08-07.....	169
15-091-10-07.....	169
15-091-12-07.....	169
15-091-14-07.....	169
15-091-16-07.....	169
15-091-18-07.....	169
15-095-10-07.....	169
15-095-17-07.....	169
15-095-20-07.....	169
15-095-22-07.....	169
15-100-01-07.....	170
15-100-02-07.....	170
15-100-03-07.....	170
15-100-04-07.....	170
15-101-01-07.....	170
15-101-02-07.....	170
15-101-03-07.....	170
15-101-04-07.....	170
15-161-01-07.....	170
15-161-02-07.....	170
15-171-08-07.....	171
15-171-10-07.....	171
15-171-12-07.....	171
15-171-14-07.....	171
15-171-16-07.....	171
15-171-18-07.....	171
15-172-08-07.....	171
15-172-10-07.....	171
15-172-12-07.....	171
15-172-14-07.....	171
15-172-16-07.....	171
15-172-18-07.....	171
15-220-01-07.....	172
15-220-02-07.....	172
15-220-03-07.....	172
15-220-04-07.....	172
15-220-06-07.....	172
15-221-01-07.....	172
15-221-02-07.....	172
15-221-03-07.....	172
15-221-04-07.....	172
15-221-06-07.....	172
15-222-01-07.....	172
15-222-02-07.....	172
15-222-03-07.....	172
15-222-04-07.....	172
15-222-06-07.....	172
15-293-01-07.....	173
15-293-02-07.....	173
15-293-03-07.....	173
15-293-04-07.....	173
15-293-05-07.....	173
15-301-16-07.....	173
15-301-25-07.....	173
15-317-01-07.....	174
15-317-02-07.....	174
15-317-03-07.....	174
15-317-04-07.....	174
15-317-05-07.....	174
15-317-06-07.....	174
15-317-07-07.....	174
15-317-08-07.....	174
15-317-09-07.....	174
15-655-00-01.....	175
15-655-01-01.....	175
15-655-02-01.....	175
15-655-03-01.....	175
15-700-05-07.....	180
15-702-07-07.....	180
15-703-07-07.....	180
15-704-07-07.....	180
15-714-07-07.....	180
15-714-10-07.....	180
15-715-07-07.....	180
15-715-10-07.....	180
15-717-10-07.....	181
15-723-10-07.....	181
15-723-20-07.....	181
15-725-14-07.....	182
15-727-14-07.....	182
15-732-20-07.....	183
15-733-21-07.....	183
15-733-22-07.....	183
15-734-20-07.....	184
15-734-24-07.....	184
15-734-26-07.....	184
15-735-20-07.....	184
15-735-24-07.....	184
15-735-26-07.....	184
15-736-26-07.....	185
15-737-26-07.....	185
15-738-25-07.....	186
15-738-26-07.....	185
15-739-25-07.....	186
15-739-26-07.....	185
15-740-13-07.....	187
15-741-13-07.....	187

## Nummern-Index

Index of order numbers

Índice de números de referencia

Index numérique des références de commande

Elenco dei codici

15-748-10-07.....	187	15-813-60-07.....	204	15-902-34-09.....	209	18-528-15-01.....	231	20-010-23-07.....	52
15-749-10-07.....	187	15-813-65-07.....	204	15-902-35-09.....	209	18-528-20-01.....	231	20-011-15-07.....	52
15-750-13-07.....	188	15-813-70-07.....	204	15-902-36-09.....	209	18-529-30-07.....	231	20-011-18-07.....	52
15-750-16-07.....	188	15-813-80-07.....	204	15-902-51-09.....	209	18-529-35-07.....	231	20-011-21-07.....	52
15-751-13-07.....	188	15-813-85-07.....	204	15-902-52-09.....	209	18-529-45-07.....	231	20-011-23-07.....	52
15-751-16-07.....	188	15-814-10-07.....	205	15-902-53-09.....	209	18-531-01-07.....	231	20-012-15-07.....	52
15-752-13-07.....	189	15-814-20-07.....	205	15-902-54-09.....	209	18-533-01-07.....	232	20-012-18-07.....	52
15-753-13-07.....	189	15-814-21-07.....	205	15-902-55-09.....	209	18-535-00-07.....	232	20-012-21-07.....	52
15-754-15-07.....	189	15-814-22-07.....	205	15-902-56-09.....	209	18-540-15-01.....	232	20-012-23-07.....	52
15-755-13-07.....	190	15-814-23-07.....	205	15-902-57-09.....	209	18-540-20-01.....	232	20-013-15-07.....	52
15-756-13-07.....	190	15-814-24-07.....	205	15-903-01-07.....	210	18-540-25-01.....	232	20-013-18-07.....	52
15-757-11-07.....	190	15-814-25-07.....	205	15-903-02-07.....	210	18-540-35-01.....	232	20-013-21-07.....	52
15-759-11-07.....	190	15-814-26-07.....	205	15-903-03-04.....	210	18-542-21-01.....	233	20-013-23-07.....	52
15-761-05-07.....	191	15-814-27-07.....	205	15-906-00-07.....	211, 212	18-543-27-01.....	233	20-016-15-09.....	52
15-761-06-07.....	191	15-814-40-07.....	205	15-906-01-07.....	212	18-544-16-07.....	233	20-016-18-09.....	52
15-761-07-07.....	191	15-814-41-07.....	205	15-906-02-07.....	212	18-544-20-07.....	233	20-017-15-09.....	52
15-762-05-07.....	191	15-814-42-07.....	205	15-906-06-07.....	212	18-544-28-07.....	233	20-017-18-09.....	52
15-762-06-07.....	191	15-814-43-07.....	205	15-906-07-07.....	212	18-545-00-01.....	234	20-018-15-09.....	52
15-762-07-07.....	191	15-814-44-07.....	205	15-906-11-07.....	212	18-545-01-01.....	234	20-018-18-09.....	52
15-765-13-07.....	192	15-814-45-07.....	205	15-906-13-07.....	212	18-545-02-01.....	234	20-019-15-09.....	52
15-767-13-07.....	192	15-814-46-07.....	205	15-906-41-07.....	212	18-545-10-01.....	234	20-019-18-09.....	52
15-768-00-07.....	193	15-814-47-07.....	205	15-906-42-07.....	212	18-545-11-01.....	234	20-020-15-09.....	52
15-768-19-07.....	193	15-814-48-07.....	205	15-906-43-07.....	212	18-545-12-01.....	234	20-020-18-09.....	52
15-768-25-07.....	193	15-814-49-07.....	205	15-906-44-07.....	212	18-545-13-01.....	234	20-020-21-09.....	52
15-768-32-07.....	193	15-814-99-07.....	205	15-906-46-07.....	212	18-545-15-01.....	234	20-020-23-09.....	52
15-769-00-07.....	193	15-901-01-07.....	206, 207	15-906-47-07.....	212	18-553-09-07.....	235	20-021-15-09.....	52
15-770-13-07.....	194	15-901-02-07.....	206, 207	15-906-50-07.....	211, 212	18-554-09-07.....	235	20-021-18-09.....	52
15-770-16-07.....	194	15-901-03-07.....	206, 207	15-975-13-01.....	220	18-555-09-07.....	235	20-021-21-09.....	52
15-770-20-07.....	194	15-901-11-09.....	207	15-975-16-01.....	98, 220	18-556-06-07.....	235	20-021-23-09.....	52
15-770-26-07.....	194	15-901-13-09.....	207	<b>18</b>		18-569-21-01.....	236	20-022-15-09.....	52
15-771-13-07.....	194	15-901-14-09.....	207	18-521-21-01.....	226	18-571-21-01.....	236	20-022-18-09.....	52
15-771-16-07.....	194	15-901-15-09.....	207	18-522-10-01.....	226	18-572-05-07.....	236	20-022-21-09.....	52
15-771-20-07.....	194	15-901-16-09.....	207	18-523-06-01.....	226	18-572-10-07.....	236	20-023-15-09.....	52
15-771-26-07.....	194	15-901-17-09.....	207	18-523-07-01.....	226	18-572-15-07.....	236	20-023-18-09.....	52
15-773-13-07.....	195	15-901-18-09.....	207	18-523-08-01.....	226	18-573-05-07.....	236	20-023-21-09.....	52
15-774-00-07.....	196	15-901-21-09.....	207	18-523-09-01.....	226	18-573-10-07.....	236	20-023-23-09.....	52
15-774-25-07.....	196	15-901-22-09.....	207	18-523-10-01.....	226	18-575-05-01.....	237	20-030-15-07.....	53
15-774-40-07.....	196	15-901-23-09.....	207	18-523-11-01.....	226	18-575-06-01.....	237	20-030-15-09.....	53
15-774-45-07.....	196	15-901-24-09.....	207	18-523-12-01.....	226	18-575-07-01.....	237	20-030-18-07.....	53
15-774-50-07.....	196	15-901-25-09.....	207	18-523-13-01.....	226	18-575-08-01.....	237	20-030-18-09.....	53
15-774-55-07.....	196	15-901-26-09.....	207	18-524-15-01.....	227	18-575-24-01.....	237	20-030-21-07.....	53
15-774-60-07.....	196	15-901-27-09.....	207	18-524-20-01.....	227	18-577-01-01.....	237	20-030-21-09.....	53
15-775-00-07.....	196	15-901-28-09.....	207	18-524-25-01.....	227	18-577-02-01.....	237	20-030-23-07.....	53
15-775-15-07.....	196	15-901-29-09.....	207	18-524-25-01.....	227	18-577-03-01.....	237	20-030-23-09.....	53
15-775-40-07.....	196	15-901-31-09.....	207	18-524-30-01.....	227	18-579-23-01.....	237	20-031-15-07.....	53
15-775-45-07.....	196	15-901-32-09.....	207	18-524-40-01.....	227	18-632-12-07.....	238	20-031-15-09.....	53
15-775-50-07.....	196	15-901-33-09.....	207	18-524-50-01.....	227	18-632-14-07.....	238	20-031-18-07.....	53
15-775-55-07.....	196	15-901-34-09.....	207	18-524-60-01.....	227	18-632-16-07.....	238	20-031-18-09.....	53
15-775-60-07.....	196	15-901-35-09.....	207	18-524-61-01.....	227	18-635-10-07.....	238	20-031-21-07.....	53
15-776-31-07.....	197	15-901-36-09.....	207	18-524-62-01.....	227	18-640-10-07.....	238	20-031-21-09.....	46, 53
15-777-32-07.....	197	15-901-37-09.....	207	18-524-63-01.....	227	18-640-15-07.....	238	20-031-23-07.....	53
15-778-00-07.....	198	15-901-38-09.....	207	18-524-64-01.....	227	18-640-20-07.....	231, 238	20-031-23-09.....	53
15-778-01-07.....	198	15-901-39-09.....	207	18-524-65-01.....	227	18-641-20-07.....	231, 238	20-032-15-07.....	53
15-778-02-07.....	198	15-901-41-09.....	207	18-524-70-01.....	228	18-642-20-07.....	231, 238	20-032-15-09.....	53
15-778-03-07.....	198	15-901-42-09.....	207	18-524-71-01.....	228	18-645-15-07.....	239	20-032-18-07.....	53
15-778-32-07.....	199	15-901-43-09.....	207	18-524-72-01.....	228	18-645-20-07.....	239	20-032-18-09.....	53
15-790-01-07.....	200	15-901-44-09.....	207	18-524-73-01.....	228	18-645-25-07.....	239	20-032-21-07.....	53
15-790-02-07.....	200	15-901-45-09.....	207	18-524-74-01.....	228	18-645-30-07.....	239	20-032-21-09.....	53
15-802-13-07.....	201	15-901-46-09.....	207	18-524-75-01.....	228	18-647-15-07.....	239	20-032-23-07.....	53
15-802-18-07.....	201	15-901-47-09.....	207	18-524-80-01.....	228	18-647-20-07.....	239	20-032-23-09.....	53
15-804-18-07.....	201	15-901-48-09.....	207	18-524-81-01.....	228	18-665-20-07.....	239	20-033-15-07.....	53
15-811-10-07.....	202	15-901-51-09.....	207	18-524-82-01.....	228	18-666-20-07.....	239	20-033-15-09.....	53
15-811-11-07.....	202	15-901-52-09.....	207	18-524-83-01.....	228	18-691-15-07.....	239	20-033-18-07.....	53
15-811-20-07.....	202	15-901-53-09.....	207	18-524-84-01.....	228	18-691-20-07.....	239	20-033-18-09.....	53
15-811-21-07.....	202	15-901-54-09.....	207	18-524-85-01.....	228	18-691-25-07.....	239	20-033-21-07.....	53
15-811-30-07.....	203	15-901-55-09.....	207	18-525-06-01.....	229	18-691-30-07.....	239	20-033-21-09.....	53
15-811-31-07.....	203	15-901-56-09.....	207	18-525-08-01.....	229	18-691-40-07.....	239	20-033-23-07.....	53
15-811-40-07.....	203	15-901-57-09.....	207	18-525-10-01.....	229	<b>20</b>		20-033-23-09.....	53
15-811-50-07.....	203	15-901-58-09.....	207	18-525-12-01.....	229	20-002-15-07.....	52	20-048-18-07.....	53
15-811-51-07.....	203	15-901-59-09.....	207	18-526-00-01.....	230	20-002-18-07.....	52	20-049-18-07.....	53
15-811-52-07.....	203	15-902-01-07.....	208, 209	18-526-05-01.....	230	20-003-15-07.....	52	20-050-18-07.....	53
15-811-53-07.....	203	15-902-11-09.....	209	18-526-07-01.....	230	20-003-18-07.....	52	20-051-18-07.....	53
15-811-60-07.....	203	15-902-12-09.....	209	18-526-09-01.....	230	20-004-15-07.....	52	20-298-10-07.....	54
15-811-61-07.....	203	15-902-13-09.....	209	18-526-12-01.....	230	20-004-18-07.....	52	20-298-11-07.....	54
15-812-01-07.....	213	15-902-14-09.....	209	18-527-00-01.....	230	20-005-15-07.....	52	20-299-10-07.....	54
15-812-21-07.....	213	15-902-15-09.....	209	18-527-01-01.....	230	20-005-18-07.....	52	20-299-11-07.....	54
15-813-40-07.....	204	15-902-21-09.....	209	18-527-04-01.....	230	20-010-15-07.....	52	20-300-11-07.....	54
15-813-45-07.....	204	15-902-31-09.....	209	18-527-06-01.....	230	20-010-18-07.....	52	20-300-13-07.....	54
15-813-50-07.....	204	15-902-32-09.....	209	18-527-08-01.....	230	20-010-21-07.....	52	20-300-14-07.....	54
15-813-55-07.....	204	15-902-33-09.....	209	18-528-10-01.....	231			20-301-13-07.....	55

20-302-01-07.....	55
20-303-01-07.....	55
20-303-09-07.....	55
20-304-01-07.....	55
20-304-09-07.....	55
20-305-01-07.....	55
20-305-09-07.....	55
20-306-14-07.....	56
20-307-14-07.....	56
20-308-14-07.....	56
20-309-14-07.....	56
20-310-14-07.....	56
20-311-14-07.....	56
20-313-14-07.....	56
20-602-18-07.....	57
20-605-15-07.....	57
20-605-18-07.....	57
20-605-21-07.....	57
20-605-23-07.....	57
20-606-15-07.....	57
20-606-18-07.....	57
20-606-21-07.....	57
20-606-23-07.....	57
20-607-15-07.....	57
20-607-18-07.....	57
20-607-21-07.....	57
20-607-23-07.....	57
20-608-15-07.....	57
20-608-18-07.....	57
20-608-21-07.....	57
20-610-18-07.....	58
20-613-19-07.....	58
20-613-23-07.....	58
20-614-01-07.....	59
20-614-02-07.....	59
20-614-03-07.....	59
20-614-04-07.....	59
20-615-01-07.....	59
20-615-02-07.....	59
20-615-03-07.....	59
20-615-04-07.....	59
20-620-00-07.....	60
20-620-01-07.....	60
20-620-14-07.....	60
20-620-18-07.....	60
20-620-21-07.....	60
20-621-14-07.....	60
20-621-18-07.....	60
20-621-21-07.....	60
20-624-13-07.....	61
20-626-13-07.....	61
20-628-13-07.....	61
20-630-13-07.....	242
20-631-13-07.....	242
20-632-12-07.....	242
20-634-13-07.....	242
20-634-14-07.....	242
20-636-13-07.....	242
20-637-12-07.....	243
20-637-13-07.....	242
20-638-15-07.....	243
20-638-20-07.....	243
20-640-18-07.....	244
20-640-20-07.....	244
20-640-26-07.....	244
20-642-16-07.....	244
20-642-18-07.....	244
20-642-20-07.....	244
20-642-24-07.....	244
20-642-26-07.....	244
20-642-30-07.....	244
20-643-20-07.....	245
20-643-24-07.....	245
20-643-26-07.....	245
20-646-18-07.....	245
20-646-20-07.....	245
20-646-23-07.....	245
20-646-26-07.....	245
20-646-31-07.....	245
20-650-13-07.....	246
20-650-15-07.....	246
20-650-18-07.....	246
20-650-20-07.....	246
20-650-23-07.....	246
20-650-26-07.....	246
20-652-15-07.....	246
20-652-17-07.....	246
20-652-20-07.....	246
20-668-00-07.....	247
20-668-01-07.....	247
20-668-02-07.....	247
20-668-03-07.....	247
20-670-00-07.....	247
20-670-01-07.....	247
20-670-02-07.....	247
20-670-03-07.....	247
20-894-14-07.....	147
<b>22</b>	
22-152-00-07.....	250
22-152-01-07.....	250
22-152-02-07.....	250
22-152-03-07.....	250
22-152-04-07.....	250
22-152-05-07.....	250
22-152-06-07.....	250
22-152-07-07.....	250
22-152-08-07.....	250
22-152-09-07.....	250
<b>23</b>	
23-112-05-04.....	251
23-112-09-04.....	251
23-123-10-07.....	251
23-123-12-07.....	251
23-123-15-07.....	251
23-123-20-07.....	251
23-123-25-07.....	251
23-124-08-07.....	251
23-124-10-07.....	251
23-124-12-07.....	251
23-124-15-07.....	251
23-124-20-07.....	251
23-124-25-07.....	251
23-125-10-07.....	252
23-125-12-07.....	252
23-125-15-07.....	252
23-125-20-07.....	252
23-125-25-07.....	252
23-127-10-07.....	252
23-127-12-07.....	252
23-127-15-07.....	252
23-127-20-07.....	252
23-127-25-07.....	252
23-128-50-07.....	253
23-128-60-07.....	253
23-128-70-07.....	253
23-130-05-07.....	253
23-130-10-07.....	253
23-130-16-07.....	253
23-130-25-07.....	253
23-130-55-07.....	253
23-130-60-07.....	253
23-130-66-07.....	253
23-130-85-07.....	253
23-130-90-98.....	253
23-130-99-07.....	253
23-132-04-04.....	254
23-132-06-04.....	254
23-132-08-04.....	254
23-132-10-04.....	254
23-132-12-04.....	254
23-133-04-04.....	254
23-133-06-04.....	254
23-133-08-04.....	254
23-133-10-04.....	254
23-133-12-04.....	254
23-134-05-04.....	255
23-134-07-04.....	255
23-134-10-04.....	255
23-134-15-04.....	255
23-134-20-04.....	255
23-134-25-04.....	255
23-134-30-04.....	255
23-135-05-04.....	255
23-135-07-04.....	255
23-135-10-04.....	255
23-135-15-04.....	255
23-135-20-04.....	255
23-135-25-04.....	255
23-135-30-04.....	255
23-136-02-07.....	256
23-136-03-07.....	256
23-136-04-07.....	256
23-136-06-07.....	256
23-136-08-07.....	256
23-136-10-07.....	256
23-136-12-07.....	256
23-136-15-07.....	256
23-136-53-07.....	256
23-136-54-07.....	256
23-136-56-07.....	256
23-136-58-07.....	256
23-136-60-07.....	256
23-136-62-07.....	256
23-136-65-07.....	256
23-138-04-07.....	257
23-138-06-07.....	257
23-138-08-07.....	257
23-138-10-07.....	257
23-138-13-07.....	257
23-138-15-07.....	257
23-138-18-07.....	257
23-138-20-07.....	257
23-138-25-07.....	257
23-138-30-07.....	257
23-138-38-07.....	257
23-138-44-07.....	257
23-138-50-07.....	257
23-139-04-07.....	258
23-139-06-07.....	258
23-139-08-07.....	258
23-139-10-07.....	258
23-139-13-07.....	258
23-139-15-07.....	258
23-139-18-07.....	258
23-139-20-07.....	258
23-139-25-07.....	258
23-139-30-07.....	258
23-139-38-07.....	258
23-139-44-07.....	258
23-139-50-07.....	258
23-154-06-07.....	259
23-154-09-07.....	259
23-154-13-07.....	259
23-154-16-07.....	259
23-154-19-07.....	259
23-154-25-07.....	259
23-154-32-07.....	259
23-155-06-07.....	259
23-155-09-07.....	259
23-155-13-07.....	259
23-155-16-07.....	259
23-155-19-07.....	259
23-155-25-07.....	259
23-155-32-07.....	259
23-160-01-04.....	260
23-160-02-04.....	260
23-160-03-04.....	260
23-160-04-04.....	260
23-162-03-07.....	260
23-162-05-07.....	260
23-162-06-07.....	260
23-162-08-07.....	260
23-162-09-07.....	260
23-197-03-04.....	265
23-197-05-04.....	265
23-197-08-04.....	265
23-199-12-04.....	265
23-199-14-04.....	265
23-199-16-04.....	265
23-215-19-07.....	266
23-240-29-04.....	266, 267
23-254-22-04.....	266, 267
23-256-00-04.....	266, 267
23-262-19-04.....	267
23-262-90-98.....	267
23-280-01-04.....	268
23-280-02-04.....	268
23-280-03-04.....	268
23-280-04-04.....	268
23-280-05-04.....	268
23-280-10-04.....	268
23-280-20-04.....	268
23-280-30-04.....	268
23-280-40-04.....	268
23-282-01-04.....	268
23-282-02-04.....	268
23-282-03-04.....	268
23-282-04-04.....	268
23-282-10-04.....	268
23-304-10-07.....	269
23-304-20-07.....	269
23-304-30-07.....	269
23-304-40-07.....	269
23-305-01-07.....	269
23-305-02-07.....	269
23-305-03-07.....	269
23-305-04-07.....	269
23-305-05-07.....	269
23-305-06-07.....	269
23-306-10-07.....	269
23-306-20-07.....	269
23-306-30-07.....	269
23-306-40-07.....	269
23-321-02-07.....	270
23-336-25-07.....	270
23-337-25-07.....	270
23-339-25-07.....	270
23-340-03-07.....	270
23-340-04-07.....	270
23-340-05-07.....	270
23-340-06-07.....	270
23-342-01-07.....	271
23-342-10-07.....	271
23-342-20-07.....	271
23-342-30-07.....	271
23-350-01-07.....	271
23-350-02-07.....	271
23-350-03-07.....	271
23-352-13-07.....	272
23-352-14-07.....	272
23-352-17-07.....	272
23-356-21-07.....	272
23-358-00-07.....	272
23-358-01-07.....	272
23-358-12-07.....	272
23-359-00-07.....	273
23-359-10-07.....	273
23-359-11-07.....	273
23-362-11-07.....	273
23-400-01-07.....	276
23-400-02-07.....	276
23-400-03-07.....	276
23-400-04-07.....	276
23-400-10-07.....	276
23-400-11-07.....	276
23-400-12-07.....	276
23-400-20-07.....	277
23-400-21-07.....	277
23-400-25-07.....	277
23-400-26-07.....	277
23-400-30-07.....	277
23-401-18-07.....	278
23-402-19-07.....	278
23-404-18-07.....	278
23-406-16-07.....	279
23-412-20-07.....	279
23-414-19-07.....	279
23-416-11-07.....	280
23-417-11-07.....	280
23-418-15-07.....	280
23-419-15-07.....	280
23-423-01-07.....	280
23-423-02-07.....	280
23-423-03-07.....	280
23-423-04-07.....	280
23-423-05-07.....	280
23-423-06-07.....	280
23-423-07-07.....	280
23-425-06-07.....	281
23-425-10-07.....	281
23-425-13-07.....	281
23-425-19-07.....	281
23-425-25-07.....	281
23-426-06-07.....	281
23-426-10-07.....	281
23-426-13-07.....	281
23-426-19-07.....	281
23-426-25-07.....	281
23-427-21-07.....	281
23-428-06-04.....	282
23-429-14-04.....	282
23-432-14-04.....	282
23-432-18-04.....	282
23-433-03-04.....	282
23-433-13-04.....	282
23-433-18-04.....	282
23-434-13-07.....	283
23-436-04-07.....	283
23-436-05-07.....	283
23-436-07-07.....	283
23-436-16-07.....	283
23-437-20-04.....	284
23-439-08-07.....	284
23-461-05-07.....	284
23-461-10-07.....	284
23-461-15-07.....	284
23-461-20-07.....	284
23-461-25-07.....	284
23-484-17-07.....	285
23-485-17-07.....	285
23-486-17-07.....	285
23-487-17-07.....	285
23-495-20-07.....	285
23-497-20-07.....	285
23-499-01-07.....	290
23-499-02-07.....	290
23-499-03-07.....	290
23-499-04-07.....	290
23-510-17-07.....	290
23-513-16-07.....	290
23-516-18-07.....	291
23-517-20-07.....	291
23-523-16-07.....	291
23-527-19-07.....	291
23-777-01-07.....	296
23-777-02-07.....	296
23-801-14-07.....	296
23-815-16-07.....	296
23-819-18-07.....	296
23-826-18-07.....	297
23-828-18-07.....	297
23-829-18-07.....	297
23-832-19-07.....	297
23-833-19-07.....	297
23-835-15-07.....	298
23-837-15-07.....	298
23-846-17-07.....	298
23-847-17-07.....	298
23-853-15-07.....	298
23-864-15-07.....	298
23-865-15-07.....	298
23-876-15-07.....	298
23-877-15-07.....	298
23-879-18-07.....	299
23-881-18-07.....	299
2	

## Nummern-Index

Index of order numbers

Índice de números de referencia

Index numérique des références de commande

Elenco dei codici

23-893-23-07.....300	24-386-16-07.....146	24-748-21-07.....176	24-849-06-04.....29	24-857-05-07.....72
23-895-22-07.....300	24-386-20-07.....146	24-823-20-07.....177	24-849-07-04.....29	24-857-05-09.....72
23-897-23-07.....300	24-386-24-07.....146	24-824-20-07.....177	24-849-08-04.....29	24-857-06-07.....72
23-899-02-07.....301	24-388-16-07.....146	24-825-16-07.....177	24-849-09-04.....29	24-857-06-09.....72
23-899-03-07.....301	24-388-20-07.....146	24-827-18-07.....177	24-849-10-04.....29	24-857-07-07.....72
23-899-04-07.....301	24-388-24-07.....146	24-830-19-07.....64	24-849-99-04.....24, 26, 29	24-857-07-09.....72
23-901-23-07.....301	24-388-30-07.....146	24-831-19-07.....64	24-850-01-07.....41	24-857-08-07.....72
23-905-24-07.....302	24-389-16-07.....147	24-835-13-07.....177	24-850-02-07.....41	24-857-08-09.....72
23-907-24-07.....302	24-389-20-07.....147	24-835-13-07.....64	24-850-03-07.....41	24-857-09-07.....72
23-909-24-07.....302	24-389-24-07.....147	24-835-18-07.....177	24-850-04-07.....42	24-857-09-09.....72
23-910-22-07.....303	24-389-30-07.....147	24-835-18-07.....64	24-850-05-07.....42	24-857-10-07.....72
23-911-22-07.....303	24-390-16-07.....146	24-843-01-07.....24, 25	24-850-10-07.....42	24-857-10-09.....72
23-934-14-07.....303	24-390-20-07.....146	24-843-02-07.....25	24-850-11-07.....42	24-857-11-07.....72
23-934-17-07.....303	24-390-24-07.....146	24-843-03-07.....25	24-850-15-07.....42	24-857-11-09.....72
23-934-19-07.....303	24-390-30-07.....146	24-843-05-07.....25	24-850-20-07.....43	24-857-12-07.....72
23-934-22-07.....303	24-535-18-07.....220	24-843-06-07.....25	24-850-21-07.....43	24-857-12-09.....72
23-935-14-07.....304	24-535-21-07.....220	24-843-07-07.....25	24-850-22-07.....43	24-857-13-07.....72
23-935-17-07.....304	24-600-30-07.....306	24-843-08-07.....25	24-850-23-07.....43	24-857-13-09.....72
23-935-19-07.....304	24-600-40-07.....306	24-843-09-07.....25	24-850-24-07.....43	24-857-14-07.....72
23-935-22-07.....304	24-600-50-07.....306	24-843-10-07.....25	24-850-25-07.....43	24-857-14-09.....72
23-941-15-07.....304	24-600-60-07.....306	24-843-11-07.....25	24-850-26-07.....43	24-857-15-07.....72
23-946-15-07.....304	24-600-70-07.....306	24-843-12-07.....25	24-850-28-07.....43	24-857-15-09.....72
23-950-18-07.....305	24-602-01-01.....306	24-843-13-07.....25	24-850-30-07.....43	24-857-16-07.....72
23-951-18-07.....305	24-618-33-07.....306	24-843-14-07.....25	24-850-31-07.....43	24-857-16-09.....72
23-955-23-07.....305	24-641-01-07.....215	24-843-15-07.....25	24-850-32-07.....43	24-857-17-07.....72
23-955-27-07.....305	24-641-02-07.....215	24-843-16-07.....25	24-850-33-07.....43	24-857-17-09.....72
23-997-01-07.....274	24-641-04-07.....215	24-843-17-07.....25	24-850-50-07.....44	24-857-18-07.....72
23-997-02-07.....274	24-641-05-07.....215	24-843-18-07.....25	24-850-60-07.....44	24-857-18-09.....72
23-997-03-07.....274	24-643-01-07.....215	24-843-70-04.....24	24-851-10-07.....62	24-857-19-07.....72
23-997-04-07.....274	24-643-10-07.....215	24-844-01-07.....26, 27	24-851-11-07.....62	24-857-19-09.....72
23-997-10-07.....274	24-654-20-07.....306	24-844-02-07.....27	24-851-12-07.....62	24-858-01-07.....67
23-997-11-07.....274	24-658-21-07.....306	24-844-03-07.....27	24-851-13-07.....62	24-858-10-07.....67
23-997-12-07.....274	24-675-00-07.....307	24-844-04-07.....27	24-852-01-07.....50	24-858-11-07.....67
23-997-13-07.....274	24-676-00-07.....307	24-844-05-07.....27	24-852-02-07.....50	24-858-12-07.....67
23-997-20-07.....274	24-678-01-07.....307	24-844-06-07.....27	24-852-10-07.....50	24-858-13-07.....67
23-997-21-07.....274	24-678-02-07.....307	24-844-07-07.....27	24-852-11-07.....50	24-858-20-07.....67
23-997-22-07.....274	24-680-25-07.....308	24-844-08-07.....27	24-852-12-07.....50	24-858-21-07.....67
23-997-23-07.....274	24-681-24-07.....308	24-844-09-07.....27	24-852-25-07.....50	24-858-30-07.....67
23-997-31-07.....274	24-682-18-07.....308	24-844-10-07.....27	24-852-26-07.....50	24-860-02-07.....67
23-997-32-07.....274	24-683-24-07.....309	24-844-11-07.....27	24-852-60-07.....50	24-860-03-07.....67
23-997-33-07.....274	24-684-19-07.....309	24-844-12-07.....27	24-852-61-07.....50	24-860-04-07.....67
23-997-40-07.....274	24-685-21-07.....309	24-844-13-07.....27	24-852-70-07.....50	24-862-01-07.....68
23-997-41-07.....274	24-686-21-07.....310	24-844-14-07.....27	24-852-71-07.....50	24-862-02-07.....68
23-997-42-07.....274	24-687-21-07.....310	24-844-15-07.....27	24-852-72-07.....50	24-862-03-07.....68
23-997-43-07.....274	24-688-22-07.....310	24-844-16-07.....27	24-852-73-07.....50	24-862-04-07.....68
23-997-50-07.....274	24-690-01-07.....311	24-844-17-07.....27	24-852-74-07.....50	24-862-05-07.....68
23-997-51-07.....274	24-690-02-07.....311	24-844-18-07.....27	24-852-75-07.....50	24-862-06-07.....68
23-997-52-07.....274	24-690-03-07.....311	24-844-19-07.....27	24-852-76-07.....50	24-862-07-07.....68
23-997-53-07.....274	24-690-04-07.....311	24-844-21-07.....27	24-853-01-07.....65	24-862-10-07.....68
23-997-60-07.....274	24-690-05-07.....311	24-844-22-07.....27	24-853-02-07.....65	24-862-11-07.....68
23-997-61-07.....274	24-691-24-07.....310	24-844-23-07.....27	24-853-03-07.....65	24-862-20-07.....68
23-997-62-07.....274	24-702-01-07.....216	24-844-24-07.....27	24-854-01-07.....65	24-863-01-07.....69
23-997-63-07.....274	24-702-02-07.....94, 216	24-844-25-07.....27	24-854-02-07.....65	24-863-10-07.....69
23-997-70-07.....274	24-702-03-07.....216, 217,	24-844-26-07.....27	24-854-03-07.....65	24-863-11-07.....69
23-997-71-07.....274	.....218, 219	24-844-27-07.....27	24-854-04-07.....65	24-863-12-07.....69
23-997-72-07.....274	24-702-04-07.....216, 217	24-844-28-07.....26, 27	24-854-05-07.....65	24-863-13-07.....69
23-997-73-07.....274	24-702-05-07.....216, 217	24-844-70-04.....26	24-854-06-07.....65	24-864-01-07.....70
23-998-01-07.....275	24-702-06-07.....217	24-844-80-07.....28	24-854-07-07.....65	24-864-02-07.....70
23-998-02-07.....275	24-702-07-07.....217, 218,	24-844-81-07.....28	24-854-08-07.....65	24-865-01-07.....70
23-998-03-07.....275	.....220	24-844-82-07.....28	24-854-09-07.....65	24-865-10-07.....70
23-998-10-07.....275	24-702-08-07.....216, 217,	24-844-83-07.....28	24-854-10-07.....65	24-865-11-07.....70
23-998-11-07.....275	.....218, 220	24-844-84-07.....28	24-854-11-07.....65	24-866-01-07.....70
23-998-12-07.....275	24-702-13-07.....218, 219	24-844-85-07.....28	24-854-12-07.....65	24-866-02-07.....70
23-998-20-07.....275	24-702-14-07.....218, 219	24-844-86-07.....28	24-855-10-07.....31	24-940-01-07.....71
23-998-21-07.....275	24-702-15-07.....217, 218,	24-844-87-07.....28	24-856-01-07.....66	24-940-02-07.....71
23-998-22-07.....275	.....219	24-848-00-04.....30	24-856-02-07.....66	24-940-03-07.....71
23-998-30-07.....275	24-720-08-01.....220	24-848-01-07.....30	24-856-03-07.....66	24-940-04-07.....71
23-998-31-07.....275	24-720-11-01.....220	24-848-02-07.....30	24-856-04-07.....66	24-942-05-07.....71
23-998-32-07.....275	24-720-14-01.....220	24-848-03-07.....30	24-856-05-07.....66	24-942-07-07.....71
23-998-41-07.....275	24-720-17-01.....220	24-848-04-07.....30	24-856-06-07.....66	24-942-09-07.....71
23-998-42-07.....275	24-721-14-01.....220	24-848-05-07.....30	24-857-00-07.....73	24-942-11-07.....71
23-998-50-07.....275	24-721-17-01.....220	24-848-06-07.....30	24-857-00-09.....73	24-973-16-07.....213
23-998-51-07.....275	24-721-20-01.....220	24-848-07-07.....30	24-857-01-07.....72	24-974-17-07.....214
23-998-52-07.....275	24-738-26-07.....176	24-848-08-07.....30	24-857-01-09.....72	24-975-17-07.....214
	24-740-26-07.....176	24-849-00-04.....29	24-857-02-07.....72	24-977-27-07.....214
<b>24</b>	24-742-19-07.....176	24-849-01-04.....29	24-857-02-09.....72	24-978-01-07.....2
24-384-16-07.....146	24-742-28-07.....176	24-849-02-04.....29	24-857-03-07.....72	24-978-01-14.....2
24-384-20-07.....146	24-744-19-07.....176	24-849-03-04.....29	24-857-03-09.....72	24-978-02-07.....2
24-384-24-07.....146	24-744-28-07.....176	24-849-04-04.....29	24-857-04-07.....72	24-978-02-14.....2
24-384-30-07.....146	24-748-17-07.....176	24-849-05-04.....29	24-857-04-09.....72	24-978-03-07.....2







## Nummern-Index

Index of order numbers

Índice de números de referencia

Index numérique des références de commande

Elenco dei codici

24-981-80-14.....	17
24-981-81-07.....	17
24-981-81-14.....	17
24-981-82-07.....	17
24-981-82-14.....	17
24-981-83-07.....	17
24-981-83-14.....	17
24-981-84-07.....	18
24-981-84-14.....	18
24-981-85-07.....	18
24-981-85-14.....	18
24-981-86-07.....	18
24-981-86-14.....	18
24-981-87-07.....	18
24-981-87-14.....	18
24-981-91-07.....	18
24-981-91-14.....	18
24-981-92-07.....	18
24-981-92-14.....	18
24-981-93-07.....	18
24-981-93-14.....	18
24-982-10-07.....	19
24-982-10-14.....	19
24-982-11-07.....	19
24-982-11-14.....	19
24-982-12-07.....	19
24-982-12-14.....	19
24-982-13-07.....	19
24-982-13-14.....	19
24-996-25-07.....	31
24-996-27-07.....	32
24-996-50-07.....	32
24-996-51-07.....	32
24-998-08-07.....	33
24-998-09-07.....	33
24-998-10-07.....	33
24-999-07-07.....	33
24-999-09-07.....	33
24-999-11-07.....	33

### 28

28-429-18-07.....	88
28-429-26-07.....	108
28-466-14-07.....	91
28-466-17-07.....	91
28-467-14-07.....	92
28-467-17-07.....	92
28-468-16-07.....	105
28-469-16-07.....	106
28-471-17-07.....	94
28-472-20-07.....	101
28-472-23-07.....	101
28-473-18-07.....	118
28-473-20-07.....	118
28-473-23-07.....	118
28-474-16-07.....	96
28-475-16-07.....	97
28-477-18-07.....	124

### 36

36-391-14-07.....	148
36-395-16-07.....	148
36-395-20-07.....	148
36-743-10-07.....	271
36-743-20-07.....	271
36-743-30-07.....	271
36-743-40-07.....	271
36-743-50-07.....	271
36-859-75-07.....	34
36-859-90-07.....	34
36-861-45-07.....	34
36-861-75-07.....	34

### 37

37-115-16-07.....	148
37-115-20-07.....	148
37-521-04-07.....	292
37-521-05-07.....	292
37-525-16-07.....	292
37-531-16-07.....	292

37-541-19-07.....	292
37-543-19-07.....	292
37-545-18-07.....	292
37-546-18-07.....	292
37-547-20-07.....	293
37-549-22-07.....	293
37-550-19-07.....	293
37-557-22-07.....	293
37-559-23-07.....	293
37-560-18-07.....	293
37-562-22-07.....	293
37-568-21-07.....	294
37-572-19-07.....	294
37-579-22-07.....	294
37-581-22-07.....	294
37-583-21-07.....	295
37-584-21-07.....	295
37-585-16-07.....	295
37-593-16-07.....	261
37-594-16-07.....	261
37-595-15-07.....	261
37-597-02-07.....	261
37-597-04-07.....	261
37-597-06-07.....	261
37-597-08-07.....	261
37-601-16-07.....	261
37-605-16-07.....	261
37-606-07-07.....	262
37-606-09-07.....	262
37-606-12-07.....	262
37-607-06-07.....	262
37-608-02-07.....	262
37-608-04-07.....	262
37-608-07-07.....	262
37-608-09-07.....	262
37-608-12-07.....	262
37-609-06-07.....	263
37-610-16-07.....	263
37-612-16-07.....	263
37-616-10-07.....	264
37-616-12-07.....	264
37-616-14-07.....	264
37-620-03-07.....	264
37-620-04-07.....	264
37-622-03-07.....	264
37-622-04-07.....	264
37-622-07-07.....	264
37-622-09-07.....	264
37-622-12-07.....	264
37-623-04-07.....	264
37-623-05-07.....	264
37-623-06-07.....	264
37-623-07-07.....	264
37-671-21-07.....	286
37-673-21-07.....	286
37-674-18-07.....	286
37-676-18-07.....	286
37-680-01-07.....	287
37-680-02-07.....	287
37-680-03-07.....	287
37-680-04-07.....	287
37-680-05-07.....	287
37-680-06-07.....	287
37-680-07-07.....	287
37-680-08-07.....	287
37-680-09-07.....	287
37-680-10-07.....	287
37-680-21-07.....	286
37-681-01-07.....	288
37-681-02-07.....	288
37-681-03-07.....	288
37-681-04-07.....	288
37-681-05-07.....	288
37-681-06-07.....	288
37-681-07-07.....	288
37-681-08-07.....	288
37-681-09-07.....	288
37-681-10-07.....	288
37-681-11-07.....	288
37-681-12-07.....	288

37-681-13-07.....	288
37-682-01-07.....	289
37-682-02-07.....	289
37-682-03-07.....	289
37-682-04-07.....	289
37-682-05-07.....	289
37-684-15-07.....	178
37-686-16-07.....	178
37-687-17-07.....	178
37-702-15-07.....	178
37-704-02-07.....	179
37-704-05-07.....	179
37-704-07-07.....	179
37-704-10-07.....	179
37-731-14-07.....	148

### 55

55-803-10-04.....	10
55-803-15-04.....	11
55-803-20-04.....	20
55-803-50-04.....	73
55-997-01-04.....	21

### 80

80-010-02-04.....	323
80-010-02-12.....	323
80-042-00-04.....	322
80-042-02-04.....	322
80-042-04-04.....	322
80-043-00-04.....	323
80-043-01-04.....	323
80-043-02-04.....	323
80-044-00-04.....	322
80-093-00-04.....	322
80-093-01-04.....	322
80-094-00-04.....	323
80-094-01-04.....	323
80-094-02-04.....	323
80-286-30-04.....	321
80-286-40-04.....	319, 321
80-286-50-04.....	321
80-287-33-04.....	321
80-287-53-04.....	321
80-287-72-04.....	321
80-287-89-04.....	321
80-287-90-04.....	321
80-291-40-04.....	319, 321
80-293-40-04.....	319, 321
80-570-00-04.....	320
80-572-13-04.....	320
80-572-14-04.....	320
80-572-17-04.....	320
80-981-01-04.....	318
80-981-02-04.....	318
80-981-03-04.....	318
80-981-04-04.....	318
80-981-07-04.....	318
80-983-12-04.....	314
80-983-17-04.....	314
80-985-12-04.....	314
80-985-17-04.....	314
80-987-12-04.....	314
80-987-17-04.....	314
80-987-20-04.....	314
80-989-17-04.....	314
80-989-20-04.....	314
80-989-23-04.....	314
80-989-25-04.....	314
80-989-28-04.....	314
80-989-30-04.....	314
80-990-17-04.....	315
80-990-20-04.....	315
80-990-23-04.....	315
80-990-25-04.....	315
80-991-17-04.....	315
80-991-20-04.....	315
80-991-23-04.....	315
80-991-25-04.....	315
80-992-17-04.....	315
80-992-20-04.....	315

80-992-23-04.....	315
80-992-25-04.....	315
80-993-17-04.....	315
80-993-20-04.....	315
80-993-23-04.....	315
80-993-25-04.....	315
80-994-20-04.....	316
80-994-23-04.....	316
80-994-25-04.....	316
80-995-20-04.....	316
80-995-23-04.....	316
80-995-25-04.....	316
80-996-23-04.....	316
80-996-25-04.....	316
80-997-23-04.....	316
80-997-25-04.....	316
80-998-23-04.....	317
80-999-23-04.....	317
80-999-24-04.....	314, 317







## KLS Martin Group

### **KLS Martin Australia Pty Ltd.**

Sydney · Australia  
Tel. +61 2 9439 5316  
australia@klsmartin.com

### **KLS Martin do Brasil Ltda.**

São Paulo · Brazil  
Tel. +55 11 3554 2299  
brazil@klsmartin.com

### **KLS Martin Medical (Shanghai) International Trading Co. Ltd.**

Shanghai · China  
Tel. +86 21 5820 6251  
china@klsmartin.com

### **KLS Martin India Pvt Ltd.**

Chennai · India  
Tel. +91 44 66 442 300  
india@klsmartin.com

### **Martin Italia S.r.l.**

Milan · Italy  
Tel. +39 039 605 67 31  
italia@klsmartin.com

### **Nippon Martin K.K.**

Tokyo · Japan  
Tel. +81 3 3814 1431  
nippon@klsmartin.com

### **KLS Martin SE Asia Sdn. Bhd.**

Penang · Malaysia  
Tel. +604 505 7838  
malaysia@klsmartin.com

### **KLS Martin de México S.A. de C.V.**

Mexico City · Mexico  
mexico@klsmartin.com

### **Martin Nederland/Marned B.V.**

Huizen · The Netherlands  
Tel. +31 35 523 45 38  
nederland@klsmartin.com

### **Gebrüder Martin GmbH & Co. KG**

Moscow · Russia  
Tel. +7 499 792-76-19  
russia@klsmartin.com

### **KLS Martin Taiwan Ltd.**

Taipei 106 · Taiwan  
Tel. +886 2 2325 3169  
taiwan@klsmartin.com

### **Gebrüder Martin GmbH & Co. KG**

Dubai · United Arab Emirates  
Tel. +971 4 454 16 55  
middleeast@klsmartin.com

### **KLS Martin UK Ltd.**

London · United Kingdom  
Tel. +44 1189 000 570  
uk@klsmartin.com

### **KLS Martin LP**

Jacksonville · Florida, USA  
Tel. +1 904 641 77 46  
usa@klsmartin.com

### **Gebrüder Martin GmbH & Co. KG**

#### **A company of the KLS Martin Group**

KLS Martin Platz 1 · 78532 Tuttlingen · Germany  
P.O. Box 60 · 78501 Tuttlingen · Germany  
Tel. +49 7461 706-0 · Fax +49 7461 706-193  
info@klsmartin.com · www.klsmartin.com

